

2020



GENOVA  
**Riviera**



ACCESSORI NAUTICI / NAUTICAL ACCESSORIES







Gli articoli presenti in questo catalogo sono interamente prodotti nei  
7000 metri quadrati degli stabilimenti di Genova Italia  
(foto pagine 10 e 11).

Una realtà tutta italiana da quarant'anni nel mondo della nautica.

*The articles in this catalogue are entirely manufactured in the 7000  
square meters of establishments in Genoa Italy  
(photos pages 10 and 11).*

*One all-Italian company for forty years in the nautical world.*



 **BUSSOLE MAGNETICHE**  
**MAGNETIC COMPASSES**

- 19. WHITE STAR SERIES 6"
- 25. WHITE STAR SERIES 5"
- 32. URANIA SERIES 4"
- 40. ASTRA SERIES 4"
- 44. PEGASUS SERIES 3" 4"
- 48. POLARE SERIES 3" 4"
- 52. IDRA SERIES 3"
- 56. PHOENIX SERIES 3"
- 60. ZENITH SERIES 3"
- 66. ARTICA SERIES 2"3/4
- 70. STELLA SERIES 2"1/2
- 73. ARIES SERIES 2"1/2
- 75. COMET SERIES 2"1/2
- 78. PRISMA SERIES 2"1/4
- 80. ORION/MIZAR SERIES 1"7/8
- 82. DIVING COMPASSES

 **SISTEMI AUDIO**  
**AUDIO SYSTEM**

- 88. COUPLE SPEAKERS - FLAT SERIES Ø 165  
COUPLE SPEAKERS - NON-MAGNETIC SERIES Ø 165
- 89. COUPLE SPEAKERS - HI-FI SERIES Ø 165  
SUBWOOFER - WAVE EXTREME SERIES Ø 165
- 90. COUPLE SPEAKERS - FLAT SERIES Ø 130  
COUPLE SPEAKERS - NON-MAGNETIC SERIES Ø 130
- 91. INSIDE USE Ø 165
- 92. SINGLE SPEAKERS - 87 SERIES
- 93. COUPLE SPEAKERS - FLAT SERIES Ø 165  
COUPLE SPEAKERS - NON-MAGNETIC SERIES Ø 165
- 94. COUPLE SPEAKERS - HI-FI SERIES Ø 165
- 95. COUPLE SPEAKERS - FLAT SERIES Ø 130  
COUPLE SPEAKERS - NON-MAGNETIC SERIES Ø 130
- 96. BLUETOOTH AMPLIFIER KIT
- 98. WATERPROOF COVER CASE
- 99. DISPLAY

 **SISTEMI DI GUIDA MECCANICI**  
**MECHANICAL STEERING SYSTEMS**

- 100. STEERING SYSTEMS- MECHANICAL STEERING SYSTEMS
- 104. CONTROL CABLE FOR MECHANICAL STEERING HELM
- 105. STEERING SYSTEMS- MECHANICAL STEERING SYSTEMS  
TITANO SERIE
- 108. STEERING SYSTEMS- MECHANICAL STEERING SYSTEMS -KIT
- 110. STEERING SYSTEMS- MECHANICAL STEERING SYSTEMS  
ACCESSORIES

 **SISTEMI DI GUIDA IDRAULICI**  
**HYDRAULIC STEERING SYSTEMS**

- 112. STEERING SYSTEMS - HYDRAULIC STEERING SYSTEMS
- 113. STANDARD FEATURES/HOW THE SYSTEM WORKS
- 116. STEERING SYSTEMS- HYDRAULIC STEERING SYSTEMS  
IN KIT OUTBOARD
- 122. STEERING SYSTEMS- HYDRAULIC STEERING SYSTEMS  
IN KIT INBOARD
- 124. HYDRAULIC STEERING SYSTEM
- 128. STEERING SYSTEMS- HYDRAULIC STEERING SYSTEMS  
CONNECTION
- 135. STEERING SYSTEMS- HYDRAULIC STEERING SYSTEMS  
ACCESSORIES

 **VOLANTI**  
**STEERING WHEELS**

- 141. VR SERIES
- 144. VS SERIES

 **COMANDI**  
**LEVER CONTROL**

- 148. ONE LEVER CONTROL
- 151. TWO LEVER CONTROL
- 155. ELECTRONIC CONTROL SYSTEM ANTEA SERIES

 **CAVI CONTROLLO MOTORE**  
**ENGINE CONTROL CABLE**

- 157. ENGINE CONTROL CABLE
- 159. ENGINE CONTROL CABLE - LOW FRICTION
- 163. ENGINE CONTROL CABLE - UNIVERSAL CABLES
- 164. ENGINE CONTROL CABLE - OMC - JOHNSON - EVINRUDE
- 166. ENGINE CONTROL CABLE - MERCURY - MERCUISER -  
MARINER
- 168. ENGINE CONTROL CABLE - ACCESSORIES

 **ACCESSORI**  
**ACCESSORIES**

- 170. ACCESSORIES/SECURITY STOP KEYS FOR OUTBOARD  
ENGINES
- 171. ACCESSORIES/HAND PRIMER/FUEL HOSE
- 172. ACCESSORIES / FUEL LINE CONNECTORS
- 174. ACCESSORIES / DRAIN PLUGS
- 175. SEVERAL ACCESSORIES
- 176. ACCESSORIES / SPRING MOORING
- 177. TANK





**CERTIFICATO N. 3828/00/S**  
**CERTIFICATE No.**

SI CERTIFICA CHE IL SISTEMA DI GESTIONE PER LA QUALITÀ DI  
 IT IS HEREBY CERTIFIED THAT THE QUALITY MANAGEMENT SYSTEM OF

**RIVIERA SOCIETA' A RESPONSABILITA' LIMITATA GENOVA**

VIA INFERIORE RIO MAGGIORE 4 A 16123 Genova (GE) ITALIA

NELLE SEGUENTI UNITÀ OPERATIVE / IN THE FOLLOWING OPERATIONAL UNITS

VIA INFERIORE RIO MAGGIORE 4 A 16123 Genova (GE) ITALIA

È CONFORME ALLA NORMA / IS IN COMPLIANCE WITH THE STANDARD  
**ISO 9001:2015**

PER I SEGUENTI CAMPI DI ATTIVITÀ / FOR THE FOLLOWING FIELD(S) OF ACTIVITIES

PROGETTAZIONE E PRODUZIONE DI BUSSOLE, ALTOPARLANTI AMAGNETICI E SISTEMI DI GOVERNO  
 ELETTRICI, ELETTRONICI, IDRAULICI.

DESIGN AND PRODUCTION OF COMPASSES, ANTIMAGNETIC SPEAKERS AND ELECTRIC, ELECTRONIC AND  
 HYDRAULIC STEERING SYSTEMS.

La validità del presente certificato è subordinata a sorveglianza periodica annuale / semestrale ed al riesame completo del sistema di gestione con periodicità triennale  
 The validity of this certificate is dependent on an annual / six monthly audit and on a complete review, every three years, of the management system  
 L'uso e la validità del presente certificato sono soggetti al rispetto del documento RINA: Regolamento per la Certificazione di Sistemi di Gestione per la Qualità  
 The use and validity of this certificate are subject to compliance with the RINA document : Rules for the certification of Quality Management Systems

Prima emissione First Issue	27.09.2000	Data decisione di rinnovo Renewal decision date	25.12.2018
Data scadenza Expiry Date	25.12.2021	Data revisione Revision date	25.12.2018

Daniela Asaro  
 Genoa Management System  
 Certification, Head

**RINA Services S.p.A.**  
 Via Corsica 12 - 16128 Genova Italy



SGQ N° 002 A

Membro degli Accordi di Mutuo  
 Riconoscimento EA, IAF e ILAC  
 Signatory of EA, IAF and ILAC  
 Mutual Recognition Agreements



CISQ è la Federazione Italiana di Organismi di  
 Certificazione dei sistemi di gestione aziendale  
 CISQ is the Italian Federation of  
 management system Certification Bodies



# CERTIFICATE

CISQ /RINA has issued an IQNet recognized certificate that the organization:

**RIVIERA SOCIETA' A RESPONSABILITA' LIMITATA GENOVA**

VIA INFERIORE RIO MAGGIORE 4 A 16123 Genova (GE) ITALIA

*in the following operative units:*

VIA INFERIORE RIO MAGGIORE 4 A 16123 Genova (GE) ITALIA

*has implemented and maintains a*  
**Quality Management System**  
*for the following scope:*

DESIGN AND PRODUCTION OF COMPASSES, ANTIMAGNETIC SPEAKERS AND ELECTRIC, ELECTRONIC AND HYDRAULIC STEERING SYSTEMS.

*which fulfills the requirements of the following standard:*

**ISO 9001:2015**

*Issued on: 2018-12-25*

*First Issued on: 2000-09-27*

*Expires on: 2021-12-25*

*This attestation is directly linked to the IQNet Partner's original certificate and shall not be used as a stand-alone document*

*CISQ/RINA original certificate no.: 3828/00/S*

**Registration Number: IT-14616**



Alex Stoichitoiu  
President of IQNET



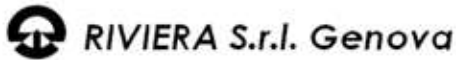
Ing. Claudio Provetti  
President of CISQ

**IQNet Partners\*:**

AENOR Spain AFNOR Certification France APCER Portugal CCC Cyprus CISQ Italy  
CQC China CQM China CQS Czech Republic Cro.Cert Croatia DQS Holding GmbH Germany FCAN Brazil  
FONDONORMA Venezuela ICONTEC Colombia Inspecta Sertifiointi Oy Finland INTECO Costa Rica  
IRAM Argentina JQA Japan KFQ Korea MIBTEC Greece MSZT Hungary Nemko AS Norway NSAI Ireland  
NYCE-SIGE Mexico PCBC Poland Quality Austria Austria RR Russia SII Israel SIQ Slovenia  
SIRIM QAS International Malaysia SQS Switzerland SRAC Romania TEST St Petersburg Russia TSE Turkey YUQS Serbia  
IQNet is represented in the USA by: AFNOR Certification, CISQ, DQS Holding GmbH and NSAI Inc.

\* The list of IQNet partners is valid at the time of issue of this certificate. Updated information is available under [www.iqnet-certification.com](http://www.iqnet-certification.com)

**POLITICA A FAVORE DELLA QUALITÀ, DELL'AMBIENTE E DELLA SICUREZZA**  
**POLICY IN FAVOR OF QUALITY, ENVIRONMENT AND SAFETY**



**Politica per la Qualità**

La MISSIONE che RIVIERA S.r.l. Genova si prefigge è:

- o progettare e produrre bussole, altoparlanti e sistemi di governo per la nautica al più alto livello qualitativo, rispondenti alle aspettative dei Clienti
- o garantire le necessarie condizioni di sicurezza e salute sul lavoro del proprio personale e di quello delle imprese appaltatrici o compresenti
- o operare salvaguardando l'ambiente interno ed esterno al proprio stabilimento.

La POLITICA PER LA QUALITÀ di RIVIERA S.r.l. Genova è pertanto:

- ✓ soddisfare le esigenze e le aspettative del Cliente mediante la loro esatta definizione, il rispetto dei termini contrattuali, la prevenzione e la gestione delle non conformità, dei resi e dei reclami; impegnarsi a fornire al Cliente assistenza post-vendita, anche in casi di fuori garanzia se giudicato strategico;
- ✓ soddisfare le esigenze e le aspettative delle altre parti interessate, significative per il buon andamento delle attività;
- ✓ gestire correttamente le attività, mediante la pianificazione ed il controllo dei processi;
- ✓ contribuire alla crescita della competenza e della professionalità del proprio personale, del suo spirito di appartenenza, dell'efficienza ed efficacia del suo operato, mediante
  - la condivisione della Politica e degli Obiettivi per la Qualità
  - la condivisione delle conoscenze organizzative
  - attività idonee di formazione ed aggiornamento;
- ✓ garantire il pieno rispetto delle prescrizioni di legge e volontarie applicabili al fine di realizzare prodotti a norma per differenziarsi dalla concorrenza e consolidare la nicchia di mercato
- ✓ adottare i processi tecnologici, economicamente sostenibili, che offrono i migliori rendimenti qualitativi nel rispetto pieno dell'ambiente, della salute e della sicurezza dei lavoratori
- ✓ perseguire il miglioramento continuo dei processi e dell'efficacia complessiva del proprio Sistema di Gestione per la Qualità secondo la norma UNI EN ISO 9001:2015.

Per dare attuazione alla Politica per la Qualità, la Direzione:

- determina i rischi e le opportunità per la gestione, l'efficacia ed il miglioramento del Sistema di Gestione per la Qualità
- definisce gli obiettivi per la qualità precisando i relativi indicatori, le modalità di misurazione e controllo, gli indici di miglioramento perseguibili;
- valuta la congruità delle risorse disponibili, provvedendo alle necessarie integrazioni;
- assicura la necessaria informazione e formazione del personale;
- analizza le performance dei processi, individuando le eventuali cause del mancato conseguimento degli obiettivi di miglioramento precedentemente fissati ed adottando i provvedimenti correttivi necessari.

Tutti i collaboratori della RIVIERA S.R.L. GENOVA sono tenuti a dare il proprio contributo per la completa soddisfazione delle esigenze della Clientela e per la migliore attuazione del Sistema di Gestione per la Qualità.

**MEANS OF RESCUE AND MINIMUM SAFETY EQUIPMENT TO KEEP ON BOARD OF BOATS AND VESSELS OF PLEASURE CONSIDERING THE DISTANCE FROM THE COST OR FROM THE SHORE.**

**SPECIES OF NAVIGATION**  
(the "X" means obligation, the number in parenthesis indicates the quantity)

**A) Safety equipment for the units' pleasure (with or without the marking CE)**

	Without any limit	Without 50 miles	Without 12 miles	Without 6 miles	Without 3 miles	Without 1 miles	Without 300 meters	In rivers, torrents and in streams
<i>liferaft for all people on board</i>	X	X						
<i>buoyant apparatus for all people on board</i>			X					
<i>rescue belts (one belt for any person on board)</i>	X	X	X	X	X	X		X
<i>lifebuoy with line</i>	X (1)	X (1)	X (1)	X (1)	X (1)	X (1)		X (1)
<i>light buoy</i>	X (1)	X (1)	X (1)	X (1)				
<i>smoke buoy</i>	X (3)	X (2)	X (2)	X (2)	X (1)			
<i>compass and deviation table (a)</i>	X	X	X					
<i>clock</i>	X	X						
<i>barometer</i>	X	X						
<i>binoculars</i>	X	X						
<i>nautical charts of the area in which there is the navigation</i>	X	X						
<i>instruments Charts</i>	X	X						
<i>hand flares red light</i>	X (4)	X (3)	X (2)	X (2)	X (2)			
<i>parachute flares red light</i>	X (4)	X (3)	X (2)	X (2)				
<i>first aid kit (b)</i>	X	X						
<i>navigation lights (c)</i>	X	X	X	X	X			
<i>sound signaling devices</i>	X	X	X	X	X			
<i>tool radiopositioning</i>	X	X						
<i>apparatus WHF</i>	X	X	X					
<i>a radio spot</i>	X	X						
<i>E.P.I.R.B. (Emergency Position Indicating Radio Beacon)</i>	X							

**B) additional safety equipment for the units without marking CE**

<i>pump or other tool of exhaustion</i>	X	X	X	X	X	X		
<i>Fire – fighting equipment / fire extinguishers, as showed at the table all.</i>	X	X	X	X	X	X		
<i>A) attached to the Decree of the Ministry 21 January 1994 n. 232 (e)</i>								

**Notes:**

- a) the deviation tables are mandatory for the pleasure boats.
- b) according with the attached D table to the Decree of the Ministry of Health n. 279 of the 28 May 1988.
- c) in case of day time navigation up to 12 miles from the cost, the navigation lights can be replaced with a safety torch with a white light.
- d) for the units with a length exceeding 12 meters is mandatory also the whistle and the bell. (The bell can be replaces with a portable sound device).
- e) the boats, regardless of the power of the engine, must have on board just 1 fire extinguisher. For the boats, the number of the 1 fire extinguishers and the extinguishing capacity are fixed at the LETTER "A" of the table attached to the cited D.M. 232/1994 (ORDER of MINISTER 232/1994)

**MEZZI DI SALVATAGGIO E DOTAZIONI DI SICUREZZA MINIME DA TENERE  
A BORDO DELLE IMBARCAZIONI E NATANTI DI PORTO IN RELAZIONE ALLA  
DISTANZA DALLA COSTA O DALLA RIVA**

**SPECIE DI NAVIGAZIONE**  
(la "X" indica l'obbligatorietà - il numero tra parentesi indica le quantità)

**A) Dotazioni di sicurezza per le unità da diporto (con o senza marcatura CE)**

	Senza alcun limite	Entro 50 miglia	Entro 12 miglia	Entro 6 miglia	Entro 3 miglia	Entro 1 miglia	Entro 300 metri	Nei fiumi torrenti e corsi d'acqua
zattera di salvataggio (per tutte le persone a bordo)	X	X						
apparecchi galleggianti (per tutte le persone a bordo)			X					
cinture di salvataggio (una per ogni persona a bordo)	X	X	X	X	X	X		X
salvagente anulare con cima	X (1)	X (1)	X (1)	X (1)	X (1)	X (1)		X (1)
boetta luminosa	X (1)	X (1)	X (1)	X (1)				
boetta fumogena	X (3)	X (2)	X (2)	X (2)	X (1)			
bussola e tabelle di deviazione (a)	X	X	X					
orologio	X	X						
barometro	X	X						
binocolo	X	X						
carte nautiche della zona in cui si effettua la navigazione	X	X						
strumenti da carteggio	X	X						
fuochi a mano a luce rossa	X (4)	X (3)	X (2)	X (2)	X (2)			
razzi a paracadute a luce rossa	X (4)	X (3)	X (2)	X (2)				
cassetta di pronto soccorso (b)	X	X						
fanali regolamentari (c)	X	X	X	X	X			
apparecchi di segnalazione sonora	X	X	X	X	X			
strumento di radioposizionamento	X	X						
appartato VHF	X	X	X					
riflettore radar	X	X						
E.P.I.R.B. (Emergency Position Indicating Radio Beacon)	X							

**B) Ulteriori dotazioni di sicurezza per le unità senza marcatura CE**

Pompa o altro attrezzo di esaurimento	X	X	X	X	X	X		
Mezzi antincendio - estintori: come indicato nella Tabella Ali. A) annessa al D.M. 21 gennaio 1994 n. 232 (e)	X	X	X	X	X	X		

**Note:**

- le tabelle di deviazioni sono obbligatorie solo per le imbarcazioni da diporto.
- secondo la tabella D allegata al Decreto del Ministero della Sanità n. 279 del 28 maggio 1988.
- nel caso di navigazione diurna fino a dodici miglia dalla costa i fanali regolamentari possono essere sostituiti con una torcia di sicurezza a luce bianca.
- per le unità aventi una lunghezza superiore a metri 12 è obbligatorio anche il fischio e la campana. (la campana può essere sostituita da un dispositivo sonoro portatile).
- i natanti, indipendentemente dalla potenza del motore, devono avere a bordo solo un estintore. Per le imbarcazioni, il numero degli estintori e la capacità estinguente sono stabiliti alla lettera "A" della tabella annessa al citato D.M. 232/1994.





Riviera srl Genova dal 1976, anno della sua nascita, si dedica alla progettazione, alla costruzione e allo sviluppo delle bussole magnetiche e degli accessori nautici.

Il passare del tempo e il costante sviluppo hanno portato Riviera srl Genova ad avere prodotti molto affidabili e aggiornati tecnicamente, sempre mantenendo la tradizione marinara della semplicità e praticità del suo utilizzo.

Tutto ciò ha fatto sì che i suoi prodotti sono presenti in tutta la cantieristica navale sia da diporto che da lavoro. Le Certificazioni e le Approvazioni che hanno ottenuto sia i suoi prodotti che il suo Sistema Qualità, sono la conferma del costante impegno di Riviera srl Genova alla ricerca della qualità e affidabilità nella sua produzione. La bussola magnetica, strumento indispensabile per la navigazione sia costiera che d'altura, prodotta da Riviera srl Genova offre una serie di requisiti che sono di fondamentale importanza quali la grande facilità di lettura della rosa graduata, compensazione magnetica e mantenimento delle prestazioni in condizioni climatiche variabili, riparabilità di qualunque parte possa essere danneggiata.

La produzione di Riviera srl Genova consta, oltre alle sopracitate bussole magnetiche, di una serie di accessori nautici quali:

- timonerie meccaniche con relativi cavi di trasmissione;
- timonerie idrauliche per motori fuoribordo ed entro-bordo;
- leve elettroniche disponibili nella versione completamente gestita da componenti elettronici o nella versione elettropneumatica che le permettono di essere compatibili con qualsiasi tipologia di motore;
- monoleve e bileve a cruscotto;
- altoparlanti amagnetici e impermeabili;
- volanti;
- cavi controllo motore;
- tubazioni benzina;
- pompe benzina e accessori collegamento motori fuoribordo;
- chiavette di sicurezza motori fuoribordo;
- serbatoi benzina;

Questa serie di articoli viene progettata, prodotta e commercializzata da Riviera srl Genova, che ne garantisce la qualità e l'affidabilità nel tempo.



## DOVE SIAMO / WHERE WE ARE COME RAGGIUNGERCI HOW TO REACH US

Uscita GE-EST: indicazione a sinistra per Piacenza, proseguire per 3 Km.  
Uscita GE-OVEST: indicazione Centro Città Km 10.

Exit GE-EST: Left indication for S.S 45 Piacenza, continue for 3 Km.  
Exit GE-OVEST: City center indication Km 10.

Riviera srl Genova has been designing and manufacturing quality magnetic compasses and nautical instruments in Italy since 1976 and exporting worldwide.

Riviera srl Genova, with its constant developments, has achieved reliable and Technically up-to-date products, always following the maritime tradition of simplicity and practical use.

These kinds of efforts have made Riviera products suitable for both leisure and commercial use whether you venture offshore or stay near the coast.

Riviera has obtained European Certifications and Approvals both of products and quality systems, so the results of the constant work of the Riviera team are always quality and reliable products.

Riviera magnetic compasses offer a series of essential features as:

- outstanding legibility of the card,
- magnetic compensation,
- reliable performance whatever the weather conditions.

We also offer our repair service: we can repair any damaged compass part, after sending you a quotation for the necessary repairs.

Riviera accessories and spares:

- mechanical steering systems with cables,
- outboard and inboard hydraulic steering systems,
- electronic levers,
- electro pneumatic levers suitable for any type of engines,
- single lever and two lever top mount controls,
- steering wheels,
- engine control cables,
- waterproof non-magnetic speakers,
- fuel hose,
- fuel pumps and outboard engine connectors,
- security stop keys for outboard engines,
- fuel tanks.

Riviera srl guarantees the quality and reliability of all the company's products.

## AREA DI PRESENZA IN ITALIA AREA OF PRESENCE IN ITALY

Attualmente Riviera srl Genova copre il territorio nazionale con una rete vendita composta da Agenti aziendali qualificati ed introdotti nel settore, l'elenco completo dei distributori è presente sul sito: [www.rivieragenova.com](http://www.rivieragenova.com).

Currently Riviera srl Genova covers the national territory with a net sale composed by qualified business Agents and introduced in the sector, the complete list of the distributors is present on the web site: [www.rivieragenova.com](http://www.rivieragenova.com).

## AREA DI PRESENZA NEL MONDO AREA OF PRESENCE IN THE WORLD

L'azienda è presente nei principali mercati mondiali, l'elenco completo dei distributori è presente sul sito: [www.rivieragenova.com](http://www.rivieragenova.com).

The company is present in the main worldwide markets, the complete list of the distributors is present on the web site: [www.rivieragenova.com](http://www.rivieragenova.com).



**Riviera è presente in varie esposizioni del settore in Italia e nel mondo.**  
**Riviera is present in various exhibitions of the nautical sector in Italy and in the world.**

Salone Nautico Cannes / Yachting Festival Cannes

Salone Nautico Amsterdam / Mets Amsterdam



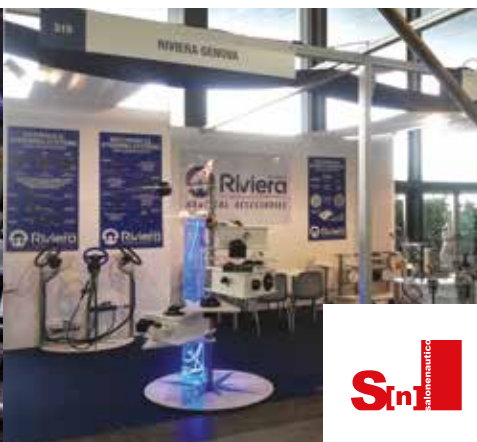
Salone Nautico Dusseldorf / Boot Dusseldorf

Salone Nautico Dubai / Dubai International Show



Salone Nautico Shanghai / Shanghai International Boat Show

Salone Nautico Genova / Genoa Boat Show





UFFICIO TECNICO  
*RESEARCH AND DEVELOPMENT DEPT.*



UFFICIO TECNICO  
*RESEARCH AND DEVELOPMENT DEPT.*



REPARTO PROGETTAZIONI STAMPI  
*MOULD PLANNING DEPT.*



REPARTO COSTRUZIONE STAMPI  
*MOULD MANUFACTURING DEPT.*



REPARTO COSTRUZIONE STAMPI  
*MOULD MANUFACTURING DEPT.*



REPARTO STAMPAGGIO  
*MOULDING DEPT.*

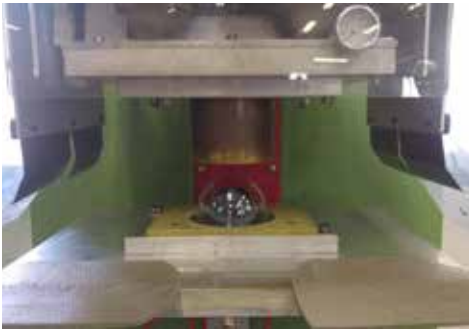


REPARTO STAMPAGGIO  
*MOULDING DEPT.*



REPARTO PRODUZIONE TIMONERIE  
*STEERING PRODUCTION DEPT.*





REPARTO PRODUZIONE BUSSOLE  
*COMPASSES PRODUCTION DEPT.*



REPARTO PRODUZIONE BUSSOLE  
*COMPASSES PRODUCTION DEPT.*



REPARTO PRODUZIONE ALTOPARLANTI  
*SPEAKERS PRODUCTION DEPT.*



REPARTO PRODUZIONE CAVI  
*STEERING CABLES PRODUCTION DEPT.*



LINEA PER PRODUZIONE TUBI  
*PIPES PRODUCTION LINE*



CONTROLLO QUALITA'  
*QUALITY CONTROL*



CONTROLLO QUALITA'  
*QUALITY CONTROL*



MAGAZZINO PARTENZE  
*WAREHOUSE GOODS IN DEPARTURES*

# BUSSOLE MAGNETICHE / MAGNETIC COMPASSES

		WHITE STAR						URANIA																
		B6W1	B6W2	B6W3	B6W4	B6W5	B6W6	BW1	BW2	BW3	BW4	BW5	BW6	BU1	BU2	BU3	BU4	BU5	BU6	BU7	BU8	BU9	BU10	
CERTIFICAZIONI CERTIFICATIONS	CERTIFICAZIONE MED MED CERTIFICATION	⊗	⊗	⊗	⊗	⊗		⊗	⊗	⊗	⊗			⊗	⊗	⊗	⊗	⊗	⊗	⊗				
	DEC. MIN. 388/99	•	•	•	•	•		•	•	•	•			•	•	•	•	•	•	•				
TIPO IMBARCAZIONE BOATS TYPE	RINA APPROVVAL TIPO APPROVATO RINA	•	•	•	•	•		•	•	•	•			•	•	•	•	•	•	•				
	VELA / SAIL	•	•	•	•	•	•	•	•	•	•	•	•	•	•	•	•	•	•	•	•	•	•	•
	MOTORE / ENGINE	•	•	•	•	•	•	•	•	•	•	•	•	•	•	•	•	•	•	•	•	•	•	•
	GOMMONI INFLATTABLES DINGHYS																							
	LAVORO / FISHING VESSELS	•	•	•	•	•		•		•	•			•	•	•	•	•	•	•	•			
	SALVATAGGIO RESCUE BOATS	•	•	•	•	•		•	•	•	•			•	•	•	•	•	•	•	•			
MONTAGGIO MOUNT	INCASSO ORIZZONTALE HORIZ. FLUSH MOUNTED	•		•				•		•				•		•					•		•	
	INCASSO VERTICALE BULKHEAD MOUNTED																							
	CHIESUOLA / BINNACLE MOUNTED		•		•	•	•		•		•	•	•		•		•	•	•	•		•		
	STAFFA / BRACKET MOUNTED																							
	BAIONETTA BAYONET JOINT MOUNTED																							
	SUBACQUEA / SUB																							
	RILEVAMENTO HANDBEARING																							
ROSA CARD	DIAMETRO / DIAMETER	6"	6"	6"	6"	6"	6"	5"	5"	5"	5"	5"	5"	4"	4"	4"	4"	4"	4"	4"	4"	4"	4"	
	GRADI / GRADUATION	5°2'	5°2'	5°2'	5°2'	5°2'	5°2'	5°2'	5°2'	5°2'	5°2'	5°2'	5°2'	5°2'	5°2'	5°2'	5°2'	5°2'	5°2'	5°2'	5°	5°	5°	
	LETTURA FRONTALE FRONT READING																						•	
	LETTURA POSTERIORE DIRECT READING	•	•	•	•	•	•	•	•	•	•	•	•	•	•	•	•	•	•	•	•	•	•	
	LINEA DI FEDE BIANCA WHITE LUBBER LINE	•	•					•	•			•			•	•								
	LINEA DI FEDE ROSSA RED LUBBER LINE			•	•	•	•			•	•		•			•	•	•	•	•	•	•	•	•
ACCESSORI ACCESSORIES	ILLUMINAZIONE 24V DI SERIE (12V A RICH.) LIGHTING 24 V STANDARD (12V ON REQ.)	•	•	•	•	•	•	•	•	•	•	•	•											
	ILLUMINAZIONE 12V DI SERIE (24V A RICH.) LIGHTING 12V STANDARD (12V ON REQ.)													•	•	•	•	•	•	•				
	ILLUMINAZIONE 12V LIGHTING 12V																							
	ILLUMINAZIONE LED12-24 LIGHTING LED12-24																					•	•	•
	COMPENSAZIONE INCORPORATA BUILT-IN COMPENSATION	•	•	•	•	•	•	•	•	•	•	•	•	•	•	•	•	•	•	•	•	•	•	•
	CARDANICA INTERNA INTERNALLY GIMBALED	•	•	•	•	•	•	•	•	•	•	•	•	•	•	•	•	•	•	•	•	•	•	
	SEMI CARDANICA INTERNA INTERNALLY HALF GIMBALED																							
	A SPILLO JEWEL AND PIVOT MOVEMENTS																							•
	COPERTURA TELESCOPICA TELESCOPIC COVER					•																•	•	•
	COPERTURA / COVER					•			•			•			•	•		•	•	•	•			



# BUSSOLE MAGNETICHE MAGNETIC COMPASSES

COASSAD	INSTALLAZIONE MOUNT	WHITE STAR 6"	WHITE STAR 5"	URANIA 4"	PEGASUS 3"4"	POLARE 3"4"	ASTRA
POSTERIORE	CHIESUOLA BINNACLE MOUNT						
	INCASSO ORIZZONTALE HORIZONTAL FLUSH MOUNTED						
	INCASSO VERTICALE BULKHEAD MOUNTED						
DIRETTING	A STAFFA BRACKET MOUNTED						
	A BAIONETTA BAYONET JOINT MOUNTED						
FERRUTTALE	CHIESUOLA BINNACLE MOUNT						
	INCASSO ORIZZONTALE HORIZONTAL FLUSH MOUNTED						 A soffitto Over head
	INCASSO VERTICALE BULKHEAD MOUNTED						
FRONTING	A STAFFA BRACKET MOUNTED						
	A BAIONETTA BAYONET JOINT MOUNTED						
	RILEVAMENTO HANDBEARING	PRISMA 2"1/4 		ORION 2"7/8 			





IDRA 3"	PHOENIX 3"	ZENITH 3"	ARTICA 2"3/4	STELLA 2"1/2	ARIES 2"1/2	COMET 2"
						
						
						
						
						
						
						
<b>MIZAR 2"7/8</b>						

**DECRETO 29 Settembre 1999, n. 388 Regolamento recante norme per l'individuazione delle caratteristiche tecniche, i requisiti, le modalità per l'installazione a bordo delle bussole magnetiche, da utilizzare esclusivamente sulle unità da diporto.**

**IL MINISTERO DEI TRASPORTI  
E DELLA NAVIGAZIONE  
ADOTTA**

**il seguente regolamento:**

**Art. 1**

**Definizioni**

1. Ai fini del presente regolamento si intende per:
- "Amministrazione": il Ministero dei trasporti e della navigazione
  - "unità da diporto": ogni costruzione destinata alla navigazione da diporto;
  - bussola magnetica: strumento per l'orientamento, atto a determinare la direzione del nord magnetico sfruttando l'azione del campo magnetico terrestre su un ago magnetico.

**Art. 2**

**Campo di applicazione**

1. Il presente regolamento si applica alla bussola magnetica a liquido e relativi accessori, destinati alle unità da diporto.

**Art. 3**

**Requisiti**

- Le bussole magnetiche devono essere conformi al prototipo approvato dall'Amministrazione.
- Possono essere utilizzate a bordo delle unità da diporto bussole magnetiche di tipo approvato per il diporto da uno degli Stati membri dell'Unione europea e dello Spazio economico europeo.

**Art. 4**

**Caratteristiche**

- le bussole magnetiche a liquido da utilizzare sulle unità da diporto devono rispondere alle seguenti caratteristiche:
  - essere costruite con materiali idonei all'uso in ambiente marino e di tipo amagnetico ad eccezione dei magneti che devono essere di idoneo materiale magnetico con elevata rimanenza coercitiva;
  - avere una linea di fede principale che indichi la direzione avanti della nave, di larghezza in corrispondenza della gradazione della rosa, non superiore all'ampiezza delle linee di divisione del quadrante e lunghezza tale da consentire la lettura quando il mortaio è inclinato di 10° nel caso di sospensione cardanica e di 30° negli altri casi;
  - nelle bussole di tipo non emisferico il mortaio deve avere sospensione cardanica con i due passi perpendicolari fra loro con tolleranza di + - 1°. I due assi inoltre devono trovarsi sullo stesso piano con le stesse tolleranze e quello esterno deve essere orientato secondo la direzione longitudinale della nave;
  - il liquido contenuto nel mortaio deve restare limpido, libero da bolle e non emulsionarsi ne gelare a temperature comprese fra -30°C e +60°C;
  - il mortaio non deve consentire perdite di liquido o infiltrazione d'aria;
  - i vetri o altri materiali trasparenti del mortaio devono avere idonei spessori e caratteristiche;
  - il momento di inerzia dell'equipaggiamento magnetico deve essere il più possibile uniforme rispetto ai tre assi principali passanti per il punto di sospensione e deve essere sufficientemente piccolo per consentire lo smorzamento rapido dell'oscillazione;
  - l'equipaggiamento magnetico deve essere mantenuto in posto con mezzi adeguati e restare libero quando il mortaio è inclinato di 10° in qualunque direzione o di 30° se la bussola non è cardanica;
  - l'equipaggiamento magnetico non deve subire danneggiamenti o deformazioni nel campo di temperature fra -30°C e +60°C;
  - la rosa deve essere dotata di stabilità statica, meccanica e magnetica, deve avere adeguata sensibilità, un diametro effettivo non minore di 100 millimetri (70 nelle emisferiche), essere graduata in uguali intervalli non maggiori di 5°, avere cifre, viste dall'alto, crescenti in senso orario partendo da nord, e consentire la lettura ad una distanza di un metro sia alla luce del giorno che

- a quella artificiale delle graduazioni comprese in un settore di almeno 15° da ciascun lato della linea di fede;
- m) l'errore di punteria (somma algebrica dell'errore di collimazione, di eccentricità e di graduazione) non deve superare 1,5°;
- n) se dotate di cerchio cardanico, l'errore d'indice, differenza tra linea di fede e il piano verticale passante per l'asse del cerchio cardanico esterno, non deve superare 1°;
- o) l'errore d'attrito o sensibilità scarto tra il valore primitivo e quello ottenuto dopo la deflessione di un piccolo angolo, non deve superare 1°;
- p) l'errore di trascinamento, differenza tra la lettura della prora dopo un giro completo del mortaio in un minuto e mezzo a velocità costante e quella effettuata a riposo, non deve superare 3,5° per rose di diametro inferiore a 200 millimetri;
- q) l'errore di induzione dovuto all'induzione magnetica trasmessa dagli aghi sistemati nell'equipaggiamento magnetico nei compensatori di ferro dolce (sfere o barre usate per correggere la deviazione quadrante) non deve essere superiore a 1°;
- r) il tempo che impiega la rosa per ritornare a meno di 1° dal meridiano magnetico a seguito di una deflessione iniziale della rosa stessa di 90° deve essere compreso tra 45 e 60 secondi per le bussole periodiche e inferiore ai 30 secondi per quelle aperiodiche quando la componente orizzontale terrestre è di 18 mt;
- s) il mortaio, lasciato libero dopo un'inclinazione di 5° rispetto al piano orizzontale, deve tornare alla posizione originale di riposo a meno di 1°;
- t) tutti i requisiti elencati devono essere soddisfatti alla temperatura di +20°C - 3°C.

**Art. 5**

**Marcatura**

- Ogni bussola deve essere marcata in modo indelebile e leggibile con:
  - nome e sede del fabbricante e dell'eventuale importatore;
  - nome o sigla del modello;
  - data di fabbricazione;
  - estremi dell'atto di approvazione del prototipo con dichiarazione di conformità al medesimo.

**Art. 6**

**Sistemazione delle bussole a bordo**

- Il fabbricante deve corredare ogni bussola di adeguate istruzioni, anche in lingua italiana, per il suo montaggio, manutenzione ed uso.
- Il cantiere costruttore dell'unità da diporto e il proprietario, in caso di modifiche successive, devono curare che la sistemazione a bordo della bussola sia fatta e conservata in modo da assicurarne il corretto funzionamento.

**Art. 7**

**Compensazione - Verifiche**

- In occasione della prima installazione a bordo, le bussole magnetiche devono essere compensate da persone competenti autorizzate dall'Autorità marittima.
- A compensazione avvenuta deve essere rilasciata la tabella delle deviazioni residue, tabella che, dopo essere stata controfirmata dall'Autorità marittima, deve essere conservata fra i documenti di bordo, unitariamente alle istruzioni di cui all'articolo 6.

**Art. 8**

**Norma transitoria**

- Le bussole magnetiche installate su unità da diporto, costruite prima dell'entrata in vigore del presente regolamento, possono continuare ad essere utilizzate finché non se ne renda necessaria la sostituzione per cattivo stato di conservazione.

Il presente decreto, munito del sigillo dello Stato, sarà inserito nella Raccolta ufficiali e degli atti normativi della Repubblica Italiana. E' fatto obbligo a chiunque spetti di osservarlo e di farlo osservare.

Roma, 29 settembre 1999

*il Ministro: Treu*

Visto, il Guardasigilli: Diliberto  
Registrato alla Corte dei conti il 20 ottobre 1999  
Registro n. 2 Trasporti e navigazione, foglio n. 359

**Decree of September 29, 1999, n. 388. Regulation and Standards regarding the rules about the technical features, the requirements, the regulation for the installation on board of magnetic compasses, to be used exclusively on the units' pleasure.**

**THE MINISTRY OF TRANSPORT  
AND NAVIGATION IS USE TO  
adopt the following rules:**

**Art. n.1  
Definitions:**

1.The purpose of this Regulation the following definitions:  
a) "Administration": the Ministry of Transport and Navigation  
b) "Units' pleasure": any building intended for recreational boating  
c) "magnetic compass": instrument for the orientation, able to determine the direction of the magnetic north thanks to the exploitation of the earth's magnetic field on a magnetic needle.

**Art. n. 2  
Field Application**

1.The present Regulation is applicable to the magnetic compass liquid and to the relative accessories as well, for the units' pleasure.

**Art. n. 3  
Requirements**

The magnetic compasses have to be conformed to the prototype that is approved from the Administration. Can be utilised on board of unit's pleasure magnetic compasses of kind approved for the pleasure from a member state of the European Union and of the European Economic Area as well.

**Art. n. 4  
Features**

1.The magnetic liquid compasses to use on units' pleasure must correspond to the following features:  
a) They must be realised with suitable material for use in a marine environment and of magnetic type, with the exception of the magnets which must be of suitable magnetic material with high remanence coercivity.  
b) They have to have a lubber line main able to indicate the front direction of the ship, they have to have a width in correspondence with the gradation of the card, not bigger than the size of the dividing lines of the quadrant and they must have a length able to allow the reading when the mortar is inclined of 10° in case of gimbal suspension and of 30° in the others cases.  
c) In the compasses of not hemispherical kind the mortar must have gimbal suspension with the 2 axes perpendicular to each other with a tolerance of + - 1°. Also the 2 axes have to be exactly at the same level with the same tolerances and the axis outer must to be oriented considering the longitudinal direction of the boat.  
d) The liquid inside the mortar must remain limpid, free of bubbles and it must not emulsify and it must not freeze with temperatures including between -30° and +60°.  
e) The mortar must not allow losses of liquid or air infiltration as well.  
f) The glasses or even other transparent materials of the mortar must have suitable features and suitable thickness.  
g) The magnetic moment of inertia of the magnetic equipment must be the most possible uniform compared to the 3 principal axes through the suspension point and it has to be enough small to allow the fast damping of the oscillation.  
h) The magnetic equipment must be maintained in a place with appropriate means and it has to remain free when the mortar is inclined of 10° in any direction or of 30° if the compass is not gimbal.  
i) The magnetic equipment must not be damaged or deformations in the temperature range between 30°C e + 60°C  
l) The card has to be equipped of established static, mechanics and magnetic, it must have adequate sensitivity, an effective diameter not smaller than 100 millimeter, (70 millimeter in the ones hemispherical).

Also the card must to be graduated in same intervals not bigger than 5°, and it must have numbers, seen from above, increasing clockwise starting from the North and it also must allow a reading at a distance of 1 meter with the natural sunlight and with the one artificial of the graduations including in a sector of at least 15° from any side of lubber line.

m) The mistake of taper, (algebraic sum of the mistake of collimation of eccentricity and graduation) must not exceed 1,5°.  
n) If equipped with cardan wheel, the index mistake, (the different between the lubber line and the vertical plane (zone) passing through the outer gimbal circle  
o) The mistake of friction or sensitivity waste from the primitive value and the one obtained after the deflection of a small angle, must not be bigger than 1°  
p) The dragging mistake, (the difference from the reading of bow after a full circle of mortar in a 1 and ½ minute with speed constant and the one performed in rest conditions), must not be bigger than 3,5°, for card with diameter less than 200 mm.  
q) The induction mistake due to magnetic induction transmitted by the needles that are located in the magnetic equipment in compensators of soft iron, (spheres or bares used to correct the quadrantal deviation) must not to be bigger than 1°.  
r) The time necessary for the card to return to less than 1° from the magnetic meridian following a initial deflection of the rose of 90°, must be including between 45 and 60 seconds for the periodic compasses and it must be less than 30° for the aperiodic compasses when the horizontal terrestrial component is of 18  
s) The mortar, left after a swing of 5° with the respect of the horizontal plane, must return to the original resting position -1°

**Art. n. 5  
Marking**

1.Compass must be marked in an indelible way and it must be readable with:  
a) name and location of the producer and also with the details of the importer  
b) name or abbreviation of the model  
c) date of manufacture  
d) extremes of approval of the prototype with the declaration of conformity to the same

**Art. n. 6**

**Accommodation of the compasses on board**  
1.The producer must accompany any compass with the adequate instructions, also in Italian Language, (regarding the mounting, maintenance and use of the compass)  
2. The yard builder of the unit's pleasure and the owner, in case of subsequent changes, must take care the accommodation on board of the compass to ensure the proper functioning.

**Art. n. 7  
Compensation and checks**

With the occasion of the first installation on board, the magnetic compasses must be compensated from competent people and authorized from the Maritime Authority. When the compensation is done, it is relevant to have the table of the residual deviations, table that, after being countersigned from the Maritime Authority, must to be preserved with the board documents exactly like the instructions of the Art.n.6

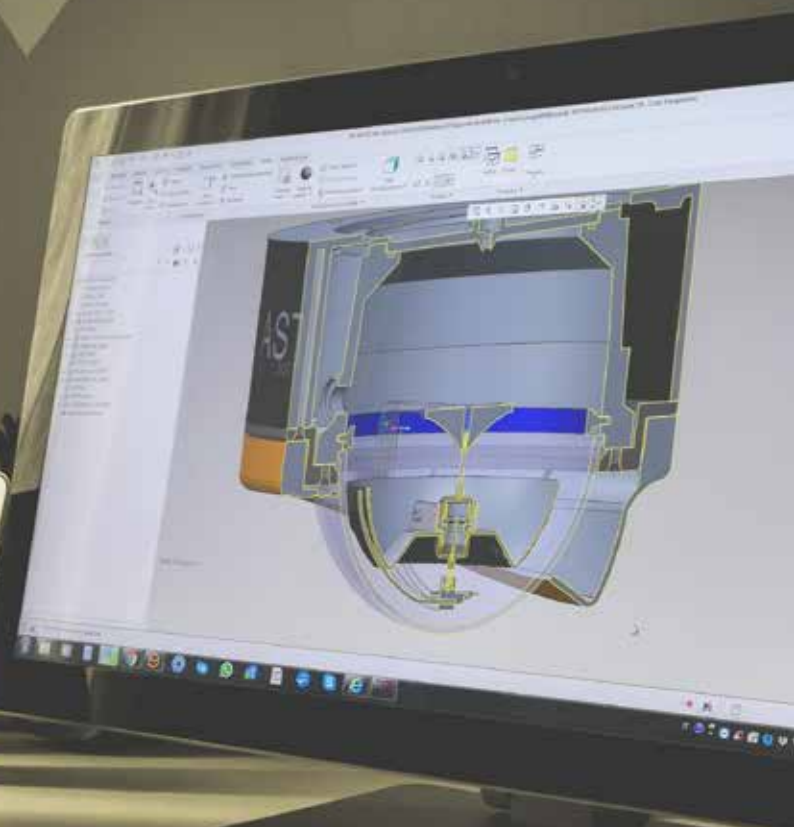
**Art. n. 8  
Transitional Rule**

1.The magnetic compasses installed on units' pleasure, realized before the entry into force of this Rules, may continue to be used until the moment will be necessary replacement for bad state of conservation. This Decree, bearing the sale of the State, will be included in the official collection and in the Legislation of the Italian Republic. All those who have the obligation to observe it must do it.

Rome, September 29, 1999

*The Minister: Treu*

By, the Kepeer:Diliberto  
Registered at Earls Court 20 October 1999  
Register n. 2, Transport ad Navigation, document n. 359





# Riviera

**BUSSOLE MAGNETICHE  
MAGNETIC COMPASSES**

---



**WHITE STAR SERIES 5" 6"**



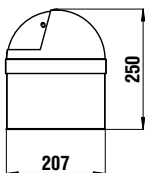


## BUSSOLE MAGNETICHE / MAGNETIC COMPASSES

SERIE WHITE STAR 6" / WHITE STAR SERIES 6"

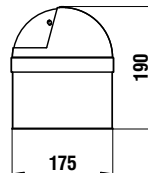
SERIE WHITE STAR 5" / WHITE STAR SERIES 5"

### B6W6



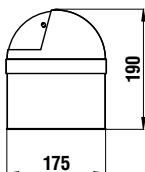
Bussola magnetica installazione a chiesuola  
*Binnacle mounted magnetic compass*

### BW6



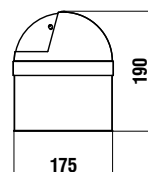
Bussola magnetica installazione a chiesuola  
*Binnacle mounted magnetic compass*

### B6W5



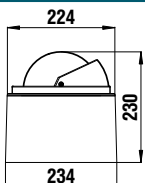
Bussola magnetica installazione a chiesuola  
*Binnacle mounted magnetic compass*

### BW5



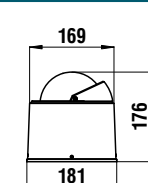
Bussola magnetica installazione a chiesuola  
*Binnacle mounted magnetic compass*

### B6W4



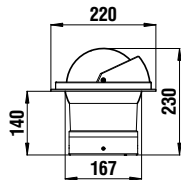
Bussola magnetica installazione a chiesuola  
*Binnacle mounted magnetic compass*

### BW4



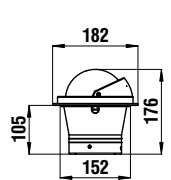
Bussola magnetica installazione a chiesuola  
*Binnacle mounted magnetic compass*

### B6W3



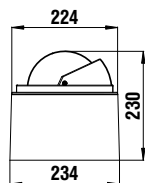
Bussola magnetica installazione a inc. orizzontale  
*Horizontal flush mounted magnetic compass*

### BW3



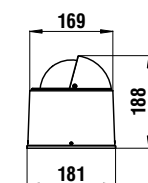
Bussola magnetica installazione a inc. orizzontale  
*Horizontal flush mounted magnetic compass*

### B6W2



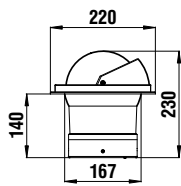
Bussola magnetica installazione a chiesuola  
*Binnacle mounted magnetic compass*

### BW2



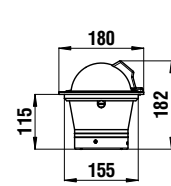
Bussola magnetica installazione a chiesuola  
*Binnacle mounted magnetic compass*

### B6W1



Bussola magnetica installazione a inc. orizzontale  
*Horizontal flush mounted magnetic compass*

### BW1



Bussola magnetica installazione a inc. orizzontale  
*Horizontal flush mounted magnetic compass*



## CARATTERISTICHE GENERALI / STANDARD FEATURES

- **Diametro apparente: 6" (150 mm)**  
*Apparent diameter: 6" (150 mm)*
- **Sospensione cardanica interna**  
*Internal gimbal*
- **Compensazione incorporata**  
*Built-in compensation*
- **Illuminazione di serie 24V (12V a rich.)**  
*Standard 24V lighting (12V on request)*
- **Schermo antiriflesso**  
*Anti-glare screen*
- **Accessibili internamente in caso di riparazione**  
*Repairability*
- **Rosa nera con gradazione di 5°, 2°**  
*Black card 5°, 2° graduation*



## OMOLOGAZIONI E CERTIFICATI / HOMOLOGATIONS AND CERTIFICATES



1

In base al Decreto Ministeriale del 27 settembre 1999 n. 388 per strumentazione di sicurezza per barche da diporto fuori dalle 6 miglia, Riviera ha avuto l'approvazione con il Decreto Ministeriale di approvazione del prototipo 586/2000 per bussole White Star 6".

Under ministerial decree (Decree for safety equipment for boats out six miles Riviera has been approved by Ministry of Transport and Navigation for compasses White Star 6" with DAP 586/2000.

2

Su richiesta *On request*

● Certificato MED in accordo con la direttiva MED 2014/90/EU riguardo alle imbarcazioni di salvataggio e battelli di emergenza.

MED Certification  
● According to the directive MED 2014/90/EU, regarding lifeboats and rescue boats

3

Su richiesta *On request*

Certificazione tipo approvato RINA per imbarcazioni da pesca e da lavoro inferiori a 150 GT.

RINA type approval certificate for merchant ships and fishing vessels of less than 150 GT



## B6W6

Le bussole B6W6 sono dotate di coperchio di protezione inox  
The B6W6 compasses have the stainless steel cover included



## B6W5

Su richiesta On request



### B6W6 installazione a chiesuola / Binnacle mounted

#### CARATTERISTICHE / KEY FEATURES

Sospensione:	Cardanica interna
<i>Gimbal type:</i>	<i>Internally gimbalead</i>
Illuminazione:	24V di serie (12V a richiesta)
<i>Lighting:</i>	<i>24V standard (12V on request)</i>
Lettura:	Posteriore - linea di fede rossa
<i>Reading:</i>	<i>Rear - red lubber line</i>
Divisione rosa:	5° - 2°
<i>Card graduations:</i>	<i>5° - 2°</i>
Diametro apparente:	6" - 150 mm
<i>Apparent card dia:</i>	<i>6" - 150 mm</i>

#### CODICI ORDINAZIONE / ORDER CODES

**62.00133.01** Inox 5° Rosa nera / *Stainless steel 5° Black card*  
**62.00134.01** Inox 2° Rosa nera / *Stainless steel 2° Black card*

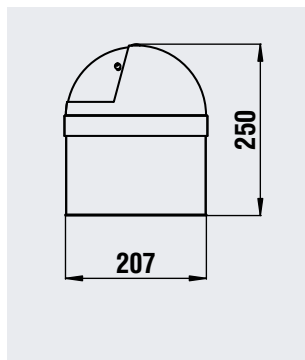
### Accessori / Accessories



Coperchio di protezione inox

*Protective cover stainless steel*

**COD. ORDINAZIONE / ORDER COD.**  
**62.00154.01**



### B6W5 installazione a chiesuola / Binnacle mounted

#### CARATTERISTICHE / KEY FEATURES

Sospensione:	Cardanica interna
<i>Gimbal type:</i>	<i>Internally gimbalead</i>
Illuminazione:	24V di serie (12V a richiesta)
<i>Lighting:</i>	<i>24V standard (12V on request)</i>
Lettura:	Posteriore - linea di fede rossa
<i>Reading:</i>	<i>Rear - red lubber line</i>
Divisione rosa:	5° - 2°
<i>Card graduations:</i>	<i>5° - 2°</i>
Diametro apparente:	6" - 150 mm
<i>Apparent card dia:</i>	<i>6" - 150 mm</i>

#### CODICI ORDINAZIONE / ORDER CODES

**62.00107.01** Bianca 5° Rosa nera / *White 5° Black card*  
**62.00108.01** Bianca 2° Rosa nera / *White 2° Black card*

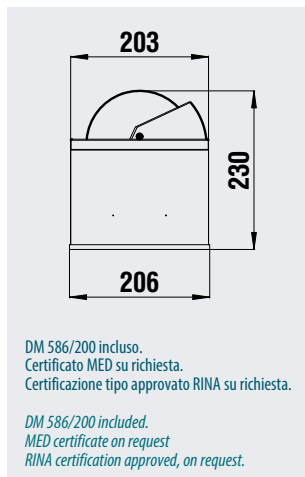
### Accessori / Accessories



Coperchio di protezione bianco

*Protective cover white*

**COD. ORDINAZIONE / ORDER COD.**  
**62.00104.01**



DM 586/200 incluso.  
Certificato MED su richiesta.  
Certificazione tipo approvato RINA su richiesta.

*DM 586/200 included.  
MED certificate on request  
RINA certification approved, on request.*



Rosa 5° / *Card graduations 5°*



Rosa 2° / *Card graduations 2°*

## B6W4

Su richiesta *On request*



Linea di fede rossa  
*Red Lubber line*

## B6W2

Su richiesta *On request*



Linea di fede bianca  
*White lubber line*



### B6W4 installazione a chiesuola / *Binnacle mounted*

#### CARATTERISTICHE / *KEY FEATURES*

Sospensione: <i>Gimbal type:</i>	Cardanica interna <i>Internally gimbaled</i>
Illuminazione: <i>Lighting:</i>	24V di serie (12V a richiesta) <i>24V standard (12V on request)</i>
Lettura: <i>Reading:</i>	Posteriore - linea di fede rossa <i>Rear - red lubber line</i>
Divisione rosa: <i>Card graduations:</i>	5° - 2° <i>5° - 2°</i>
Diametro apparente: <i>Apparent card dia:</i>	6" - 150 mm <i>6" - 150 mm</i>

#### CODICI ORDINAZIONE / *ORDER CODES*

- 62.00102.01** Nera 5° Rosa nera - Alta velocità / *Black 5° Black card - high speed*  
**62.00101.01** Nera 2° Rosa nera - Alta velocità / *Black 2° Black card - high speed*  
**62.00080.01** Nera 5° Rosa nera / *Black 5° Black card*  
**62.00079.01** Nera 2° Rosa nera / *Black 2° Black card*



Rosa 5° *Card graduations 5°*



Rosa 2° *Card graduations 2°*

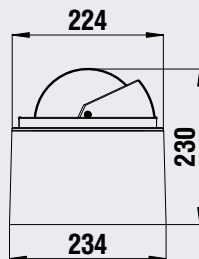
### B6W2 installazione a chiesuola / *Binnacle mounted*

#### CARATTERISTICHE / *KEY FEATURES*

Sospensione: <i>Gimbal type:</i>	Cardanica interna <i>Internally gimbaled</i>
Illuminazione: <i>Lighting:</i>	24V di serie (12V a richiesta) <i>24V standard (12V on request)</i>
Lettura: <i>Reading:</i>	Posteriore - linea di fede bianca <i>Rear - white lubber line</i>
Divisione rosa: <i>Card graduations:</i>	5° - 2° <i>5° - 2°</i>
Diametro apparente: <i>Apparent card dia:</i>	6" - 150 mm <i>6" - 150 mm</i>

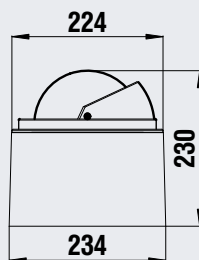
#### CODICI ORDINAZIONE / *ORDER CODES*

- 62.00084.01** Nera 5° Rosa nera - Alta velocità / *Black 5° Black card - high speed*  
**62.00083.01** Nera 2° Rosa nera - Alta velocità / *Black 2° Black card - high speed*  
**62.00076.01** Nera 5° Rosa nera / *Black 5° Black card*  
**62.00075.01** Nera 2° Rosa nera / *Black 2° Black card*



DM 586/200 incluso.  
Certificato MED su richiesta.  
Certificazione tipo approvato RINA su richiesta.

*DM 586/200 included.*  
*MED certificate on request*  
*RINA certification approved, on request.*



DM 586/200 incluso.  
Certificato MED su richiesta.  
Certificazione tipo approvato RINA su richiesta.

*DM 586/200 included.*  
*MED certificate on request*  
*RINA certification approved, on request.*



## B6W3

Su richiesta *On request*



Linea di fede rossa  
*Red Lubber line*

## B6W1

Su richiesta *On request*



Linea di fede bianca  
*White lubber line*



### B6W3 installazione ad incasso orizzontale / *Horizontal flush mounted*

#### CARATTERISTICHE / *KEY FEATURES*

Sospensione:	Cardanica interna
<i>Gimbal type:</i>	<i>Internally gimbaled</i>
Illuminazione:	24V di serie (12V a richiesta)
<i>Lighting:</i>	<i>24V standard (12V on request)</i>
Letture:	Posteriore - linea di fede rossa
<i>Reading:</i>	<i>Rear - red lubber line</i>
Divisione rosa:	5° - 2°
<i>Card graduations:</i>	<i>5° - 2°</i>
Diametro apparente:	6" - 150 mm
<i>Apparent card dia:</i>	<i>6" - 150 mm</i>

#### CODICI ORDINAZIONE / *ORDER CODES*

- 62.00100.01** Nera 5° Rosa nera - Alta velocità / *Black 5° Black card - high speed*  
**62.00099.01** Nera 2° Rosa nera - Alta velocità / *Black 2° Black card - high speed*  
**62.00078.01** Nera 5° Rosa nera / *Black 5° Black card*  
**62.00077.01** Nera 2° Rosa nera / *Black 2° Black card*



Rosa 5° / *Card graduations 5°*



Rosa 2° / *Card graduations 2°*

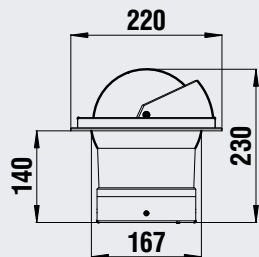
### B6W1 installazione ad incasso orizzontale / *Horizontal flush mounted*

#### CARATTERISTICHE / *KEY FEATURES*

Sospensione:	Cardanica interna
<i>Gimbal type:</i>	<i>Internally gimbaled</i>
Illuminazione:	24V di serie (12V a richiesta)
<i>Lighting:</i>	<i>24V standard (12V on request)</i>
Letture:	Posteriore - linea di fede bianca
<i>Reading:</i>	<i>Rear - white lubber line</i>
Divisione rosa:	5° - 2°
<i>Card graduations:</i>	<i>5° - 2°</i>
Diametro apparente:	6" - 150 mm
<i>Apparent card dia:</i>	<i>6" - 150 mm</i>

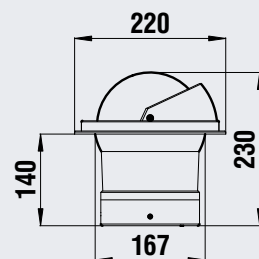
#### CODICI ORDINAZIONE / *ORDER CODES*

- 62.00082.01** Nera 5° Rosa nera - Alta velocità / *Black 5° Black card - high speed*  
**62.00081.01** Nera 2° Rosa nera - Alta velocità / *Black 2° Black card - high speed*  
**62.00074.01** Nera 5° Rosa nera / *Black 5° Black card*  
**62.00073.01** Nera 2° Rosa nera / *Black 2° Black card*



DM 586/200 incluso.  
Certificato MED su richiesta.  
Certificazione tipo approvato RINA su richiesta.

*DM 388/99 included.  
MED certificate on request  
RINA certification approved,  
on request.*



DM 586/200 incluso.  
Certificato MED su richiesta.  
Certificazione tipo approvato RINA su richiesta.

*DM 586/200 included.  
MED certificate on request  
RINA certification approved,  
on request.*

## CARATTERISTICHE GENERALI / STANDARD FEATURES



- **Diametro apparente: 5" (130 mm)**  
*Apparent diameter: 5" (130 mm)*
- **Sospensione cardanica interna**  
*Internal gimbal*
- **Compensazione incorporata**  
*Built-in compensation*
- **Illuminazione di serie 24V (12V a rich.)**  
*Standard 24V lighting (12V on request)*
- **Schermo antiriflesso**  
*Anti-glare screen*
- **Accessibili internamente in caso di riparazione**  
*Repairability*
- **Versioni "normale" e "alta velocità" (V. 25 nodi)**  
*"Standard" and "high speed" version (.25 Knots)*
- **Rosa nera con gradazione di 5°, 2°**  
*Black card 5°, 2° graduation*



## OMOLOGAZIONI E CERTIFICATI / HOMOLOGATIONS AND CERTIFICATES



1

In base al Decreto Ministeriale del 29 settembre 1999 n. 388 per strumentazione di sicurezza per barche da diporto fuori dalle 6 miglia, Riviera ha avuto l'approvazione con il Decreto Ministeriale di approvazione del prototipo 587/2000 per bussole White Star 5°.

Under ministerial decree (Decree for safety equipment for boats out six miles Riviera has been approved by Ministry of Transport and Navigation for compasses White Star 5° with DAP 587/2000.

2

Su richiesta *On request*

● Certificato MED in accordo con la direttiva MED 2014/90/EU riguardo alle imbarcazioni di salvataggio e battelli di emergenza.

MED Certification  
● According to the directive MED 2014/90/EU, regarding lifeboats and rescue boats

3

Su richiesta *On request*

Certificazione tipo approvato RINA per imbarcazioni da pesca e da lavoro inferiori a 150 GT.

RINA type approval certificate for merchant ships and fishing vessels of less than 150 GT



## BW6



Linea di fede rossa  
*Red Lubber line*

## BW5



Linea di fede bianca  
*White lubber line*

Le bussole BW6 e BW5 sono dotate di coperchio di protezione inox  
*The BW6 and BW5 compasses have the stainless steel cover included*



### BW6 installazione a chiesuola / Binnacle mounted

#### CARATTERISTICHE / KEY FEATURES

Sospensione:	Cardanica interna
<i>Gimbal type:</i>	<i>Internally gimbalead</i>
Illuminazione:	24V di serie (12V a richiesta)
<i>Lighting:</i>	<i>24 V standard (12V on request)</i>
Lettura:	Posteriore - linea di fede rossa
<i>Reading:</i>	<i>Rear - red lubber line</i>
Divisione rosa:	5° - 2°
<i>Card graduations:</i>	<i>5° - 2°</i>
Diametro apparente:	5" - 130 mm
<i>Apparent card dia:</i>	<i>5" - 130 mm</i>

#### CODICI ORDINAZIONE / ORDER CODES

- 62.00132.01** Inox 5° Rosa nera - Alta velocità / *Stainless steel 5° Black card - high speed*  
**62.00138.01** Inox 2° Rosa nera - Alta velocità / *Stainless steel 2° Black card - high speed*  
**62.00131.01** Inox 5° Rosa nera / *Stainless steel 5° Black card*  
**62.00139.01** Inox 2° Rosa nera / *Stainless steel 2° Black card*



Rosa 5° / *Card graduations 5°*



Rosa 2° / *Card graduations 2°*

### BW5 installazione a chiesuola / Binnacle mounted

#### CARATTERISTICHE / KEY FEATURES

Sospensione:	Cardanica interna
<i>Gimbal type:</i>	<i>Internally gimbalead</i>
Illuminazione:	24V di serie (12V a richiesta)
<i>Lighting:</i>	<i>24V standard (12V on request)</i>
Lettura:	Posteriore - linea di fede bianca
<i>Reading:</i>	<i>Rear - white lubber line</i>
Divisione rosa:	5° - 2°
<i>Card graduations:</i>	<i>5° - 2°</i>
Diametro apparente:	5" - 130 mm
<i>Apparent card dia:</i>	<i>5" - 130 mm</i>

#### CODICI ORDINAZIONE / ORDER CODES

- 62.00130.01** Inox 5° Rosa nera - Alta velocità / *Stainless steel 5° Black card - high speed*  
**62.00136.01** Inox 2° Rosa nera - Alta velocità / *Stainless steel 2° Black card - high speed*  
**62.00129.01** Inox 5° Rosa nera / *Stainless steel 5° Black card*  
**62.00137.01** Inox 2° Rosa nera / *Stainless steel 2° Black card*

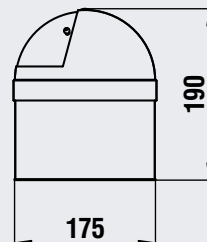
### Accessori / Accessories



Coperchio di protezione inox

*Protective cover stainless steel*

**COD. ORDINAZIONE / ORDER COD.**  
**62.00155.01**



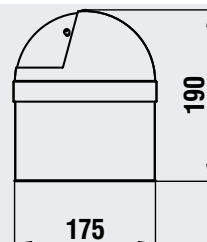
### Accessori / Accessories



Coperchio di protezione inox

*Protective cover stainless steel*

**COD. ORDINAZIONE / ORDER COD.**  
**62.00155.01**







## BW4

Su richiesta On request



### BW4 installazione a chiesuola / Binnacle mounted

#### CARATTERISTICHE / KEY FEATURES

Sospensione:	Cardanica interna
<i>Gimbal type:</i>	<i>Internally gimbale</i>
Illuminazione:	24V di serie (12V a richiesta)
<i>Lighting:</i>	<i>24 V standard (12V on request)</i>
Letture:	Posteriore - linea di fede rossa
<i>Reading:</i>	<i>Rear - red lubber line</i>
Divisione rosa:	5° - 2°
<i>Card graduations:</i>	<i>5° - 2°</i>
Diametro apparente:	5" - 130 mm
<i>Apparent card dia:</i>	<i>5" - 130 mm</i>

#### CODICI ORDINAZIONE / ORDER CODES

**62.00056.01** Nera 5° Rosa nera Alta velocità / *Black 5° Black card - high speed*

**62.00056.10** Nera 5° Rosa rossa Alta velocità / *Black 2° Red card - high speed*

**62.00140.01** Nera 2° Rosa nera Alta velocità / *Black 2° Black card - high speed*

**62.00055.01** Nera 5° Rosa nera / *Black 5° Black card*

**62.00054.01** Nera 2° Rosa nera / *Black 2° Black card*

**62.00113.01** Bianca 5° Rosa nera / *White 5° Black card*

**62.00141.01** Bianca 2° Rosa nera / *White 2° Black card*



Rosa 2° / Card graduations 2°



Rosa 5° / Card graduations 5°



Rosa 5° / Card graduations 5°

### Accessori / Accessories



Coperchio di protezione bianco

*Protective cover white*

**COD. ORDINAZIONE / ORDER COD.**  
**62.00180.01** Bianco / *White*



Coperchio di protezione bianco

*Protective cover white*

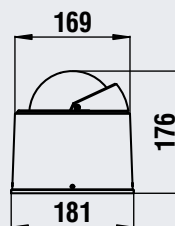
**COD. ORDINAZIONE / ORDER COD.**  
**62.00117.01** Bianco / *White*



Calotta di protezione in tela

*Protective cover Canvas hood*

**COD. ORDINAZIONE / ORDER COD.**  
**62.00062.01**



DM 587/200 incluso.  
Certificato MED su richiesta.  
Certificazione tipo approvato RINA su richiesta.

*DM 587/200 included.  
MED certificate on request  
RINA certification approved, on request.*



## BW2

Su richiesta On request



### BW2 installazione a chiesuola / Binnacle mounted

#### CARATTERISTICHE / KEY FEATURES

Sospensione:	Cardanica interna
<i>Gimbal type:</i>	<i>Internally gimbale</i>
Illuminazione:	24V di serie (12V a richiesta)
<i>Lighting:</i>	<i>24V standard (12V on request)</i>
Lettura:	Posteriore - linea di fede bianca
<i>Reading:</i>	<i>Rear - white lubber line</i>
Divisione rosa:	5° - 2°
<i>Card graduations:</i>	<i>5° - 2°</i>
Diametro apparente:	5" - 130 mm
<i>Apparent card dia:</i>	<i>5" - 130 mm</i>

#### CODICI ORDINAZIONE / ORDER CODES

**62.00021.01** Nera 5° Rosa nera Alta velocità / *Black 5° Black card - high speed*

**62.00021.10** Nera 5° Rosa rossa - Alta velocità / *Black 5° Red card - high speed*

**62.00023.01** Nera 2° Rosa nera Alta velocità / *Black 2° Black card - high speed*

**62.00025.01** Nera 5° Rosa nera / *Black 5° Black card*

**62.00027.01** Nera 2° Rosa nera / *Black 2° Black card*



Rosa 2° / *Card graduations 2°*



Rosa 5° / *Card graduations 5°*



Rosa 5° / *Card graduations 5°*

### Accessori / Accessories



Coperchio di protezione bianco

*Protective cover white*

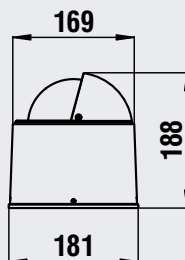
**COD. ORDINAZIONE / ORDER COD.**  
**62.00117.01** Bianco / *White*



Calotta di protezione in tela

*Protective cover Canvas hood*

**COD. ORDINAZIONE / ORDER COD.**  
**62.00062.01**



DM 587/200 incluso.  
Certificato MED su richiesta.  
Certificazione tipo approvato RINA su richiesta.

*DM 587/200 included.  
MED certificate on request  
RINA certification approved, on request.*



**BW3**  
Su richiesta On request



## BW3 installazione ad incasso orizzontale / Horizontal flush mounted

### CARATTERISTICHE / KEY FEATURES

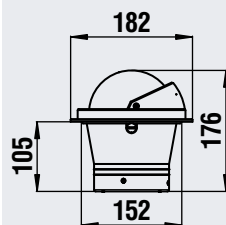
Sospensione:	Cardanica interna
<i>Gimbal type:</i>	<i>Internally gimballed</i>
Illuminazione:	24V di serie (12V a richiesta)
<i>Lighting:</i>	<i>24V standard (12V on request)</i>
Lettura:	Posteriore - linea di fede rossa
<i>Reading:</i>	<i>Rear - red lubber line</i>
Divisione rosa:	5° - 2°
<i>Card graduations:</i>	<i>5° - 2°</i>
Diametro apparente:	5" - 130 mm
<i>Apparent card dia:</i>	<i>5" - 130 mm</i>

### CODICI ORDINAZIONE / ORDER CODES *senza cover protettiva / without protective cover*

- 62.00053.01** Nera 5° Rosa nera - Alta velocità / *Black 5° Black card - high speed*
- 62.00053.10** Nera 5° Rosa rossa - Alta velocità / *Black 5° Red card - high speed*
- 62.00142.01** Nera 2° Rosa nera - Alta velocità / *Black 2° Black card - high speed*
- 62.00052.01** Nera 5° Rosa nera / *Black 5° Black card*
- 62.00051.01** Nera 2° Rosa nera / *Black 2° Black card*

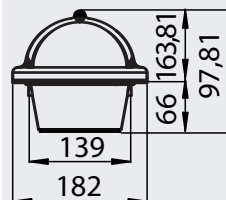
### CODICI ORDINAZIONE / ORDER CODES *con cover protettiva / with protective cover*

- 62.00856.00** Nera 5° Rosa nera - Alta velocità / *Black 5° Black card - high speed*
- 62.00856.10** Nera 5° Rosa rossa - Alta velocità / *Black 5° Red card - high speed*
- 62.00857.00** Nera 2° Rosa nera - Alta velocità / *Black 2° Black card - high speed*
- 62.00858.00** Nera 5° Rosa nera / *Black 5° Black card*
- 62.00859.00** Nera 2° Rosa nera / *Black 2° Black card*



DM 587/200 incluso.  
Certificato MED su richiesta.  
Certificazione tipo approvato RINA su richiesta.

*DM 587/200 included.  
MED certificate on request  
RINA certification approved,  
on request.*



Rosa 2° / *Card graduations 2°*



Rosa 5° / *Card graduations 5°*



## BW1

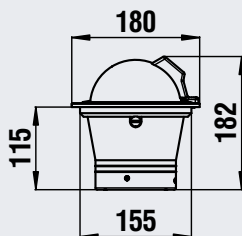
Su richiesta On request



### BW1 installazione ad incasso orizzontale / Horizontal flush mounted

#### CARATTERISTICHE / KEY FEATURES

Sospensione:	Cardanica interna
Gimbal type:	<i>Internally gimbale</i>
Illuminazione:	24V di serie (12V a richiesta)
Lighting:	<i>24V standard (12V on request)</i>
Letture:	Posteriore - linea di fede bianca
Reading:	<i>Rear - white lubber line</i>
Divisione rosa:	5° - 2°
Card graduations:	<i>5° - 2°</i>
Diametro apparente:	5" - 130 mm
Apparent card dia:	<i>5" - 130 mm</i>



DM 587/200 incluso.  
Certificato MED su richiesta.  
Certificazione tipo approvato RINA su richiesta.

*DM 587/200 included.  
MED certificate on request  
RINA certification approved,  
on request.*

#### CODICI ORDINAZIONE / ORDER CODES

**62.00013.01** Nera 5° Rosa nera - Alta velocità / *Black 5° Black card - high speed*

**62.00013.10** Nera 5° Rosa rossa - Alta velocità / *Black 2° Red card - high speed*

**62.00015.01** Nera 2° Rosa nera - Alta velocità / *Black 2° Black card - high speed*

**62.00017.01** Nera 5° Rosa nera / *Black 5° Black card*

**62.00019.01** Nera 2° Rosa nera / *Black 2° Black card*



Rosa 5° / Card graduations 5°



Rosa 5° / Card graduations 5°



Rosa 2° / Card graduations 2°

30 WHITE STAR SERIES 5"



### PERSONALIZZA IL TUO QUADRANTE CUSTOMIZE YOUR CARDS

Preventivo in base ai quantitativi richiesti  
*Quotations according to the required quantities*



Riviera fornisce un servizio ai propri clienti, su richiesta, di personalizzazione del logo sui quadranti delle proprie bussole.

*All riviera cards can be personalized on client's request.*



# Riviera

**BUSSOLE MAGNETICHE  
MAGNETIC COMPASSES**

---



**URANIA SERIES 4"**

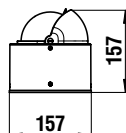




## BUSSOLE MAGNETICHE / MAGNETIC COMPASSES

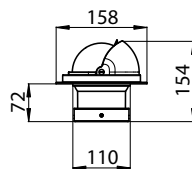
SERIE URANIA 4" / URANIA SERIES 4"

### BU9



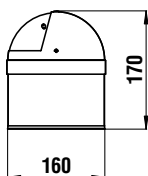
Bussola magnetica installazione a chiesuola  
*Binnacle mounted magnetic compass*

### BU8



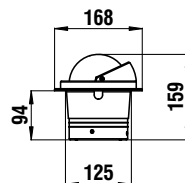
Bussola magnetica installazione a inc. orizzontale  
*Horizontal flush mounted magnetic compass*

### BU6-7



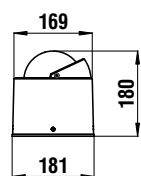
Bussola magnetica installazione a chiesuola  
*Binnacle mounted magnetic compass*

### BU3



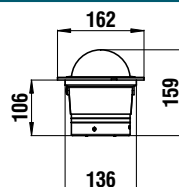
Bussola magnetica installazione a inc. orizzontale  
*Horizontal flush mounted magnetic compass*

### BU5



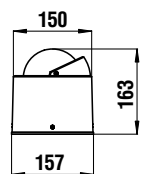
Bussola magnetica installazione a chiesuola  
*Binnacle mounted magnetic compass*

### BU1



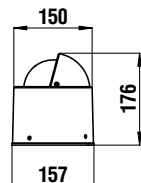
Bussola magnetica installazione a inc. orizzontale  
*Horizontal flush mounted magnetic compass*

### BU4



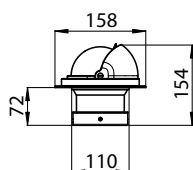
Bussola magnetica installazione a chiesuola  
*Binnacle mounted magnetic compass*

### BU2



Bussola magnetica installazione a chiesuola  
*Binnacle mounted magnetic compass*

### BU10



Bussola magnetica installazione a inc. orizzontale  
*Horizontal flush mounted magnetic compass*





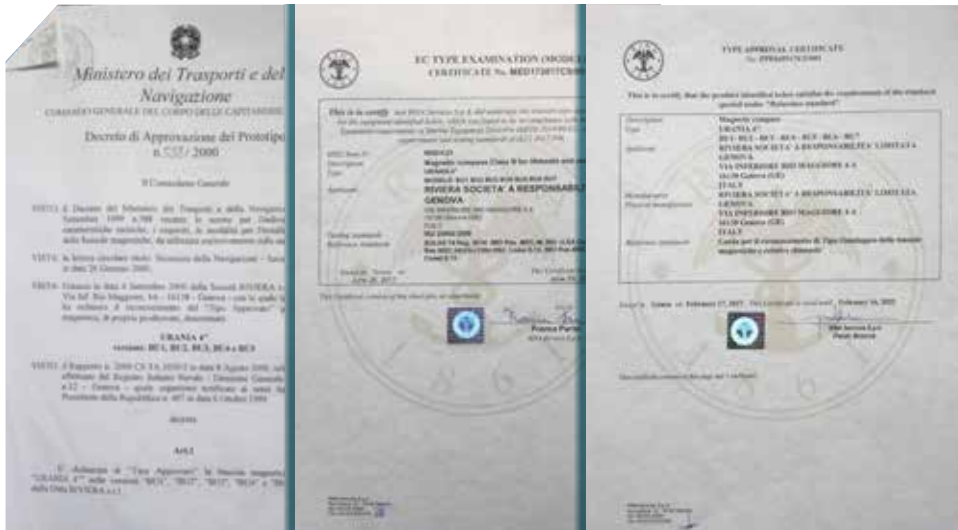
## CARATTERISTICHE GENERALI / STANDARD FEATURES



- **Diametro apparente: 4" (100 mm)**  
*Apparent diameter: 4" (100 mm)*
- **Sospensione cardanica interna**  
*Internal gimbal*
- **Compensazione incorporata**  
*Built-in compensation*
- **Illuminazione di serie 12V (24V a richiesta)**  
*Standard 12V Lighting (24V on request)*
- **Schermo antiriflesso**  
*Anti-glare screen*
- **Accessibili internamente in caso di riparazione**  
*Repairability*
- **Versioni "normale" e "alta velocità" (V. 25 nodi)**  
*"Standard" and "high speed" version (S.25 knots)*
- **Rosa nera/blu/bianca con gradazione di 5° o 2°**  
*Black/blue/white card 5° or 2° graduation*



## OMOLOGAZIONI E CERTIFICATI / HOMOLOGATIONS AND CERTIFICATES



1

In base al Decreto Ministeriale del 29 settembre 1999 n. 388 per strumentazione di sicurezza per barche da diporto fuori dalle 6 miglia, Riviera ha avuto l'approvazione con il Decreto Ministeriale di approvazione del prototipo 588/2000 per bussole Urania 4".

Under ministerial decree (Decree for safety equipment for boats out six miles)Riviera has been approved by Ministry of Transport and Navigation for compasses Urania 4" with DAP 588/2000 .

2

Su richiesta *On request*

● Certificato MED in accordo con la direttiva MED 2014/90/EU riguardo alle imbarcazioni di salvataggio e battelli di emergenza.

MED Certification  
● According to the directive MED 2014/90/EU, regarding lifeboats and rescue boats

3

Su richiesta *On request*

Certificazione tipo approvato RINA per imbarcazioni da pesca e da lavoro inferiori a 150 GT.

RINA type approval certificate for merchant ships and fishing vessels of less than 150 GT

**BU9****BU6-7**Su richiesta *On request***BU9 installazione a chiesuola / Binnacle mounted****CARATTERISTICHE / KEY FEATURES**

Sospensione:	Cardanica interna
<i>Gimbal type:</i>	<i>Internally gimbale</i>
Illuminazione:	LED 12V di serie (LED 24V a richiesta)
<i>Lighting:</i>	<i>LED 12V standard (LED 24V on request)</i>
Letture:	Posteriore - linea di fede rossa
<i>Reading:</i>	<i>Rear - red lubber line</i>
Divisione rosa:	5°
<i>Card graduations:</i>	<i>5°</i>
Diametro apparente:	4" - 100 mm
<i>Apparent card dia:</i>	<i>4" - 100 mm</i>

**CODICI ORDINAZIONE / ORDER CODES**

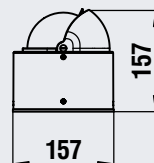
- 62.00644.10** Nera 5° Rosa nera - Alta velocità / *Black 5° Black card - high speed*
- 62.00644.11** Bianca 5° Rosa nera - Alta velocità / *White 5° Black card - high speed*
- 62.00644.30** Bianca 5° Rosa blu - Alta velocità / *White 5° Blue card - high speed*
- 62.00644.00** Nera 5° Rosa nera / *Black 5° Black card*
- 62.00644.01** Bianca 5° Rosa nera / *White 5° Black card*
- 62.00644.05** Bianca 5° Rosa blu / *White 5° Blue card*

**BU6-7 installazione a chiesuola / Binnacle mounted****CARATTERISTICHE / KEY FEATURES**

Sospensione:	Cardanica interna
<i>Gimbal type:</i>	<i>Internally gimbale</i>
Illuminazione:	LED 12V di serie (LED 24V a richiesta)
<i>Lighting:</i>	<i>LED 12V standard (LED 24V on request)</i>
Letture:	Posteriore
<i>Reading:</i>	<i>Rear</i>
Divisione rosa:	5°
<i>Card graduations:</i>	<i>5°</i>
Diametro apparente:	4" - 100 mm
<i>Apparent card dia:</i>	<i>4" - 100 mm</i>

**CODICI ORDINAZIONE / ORDER CODES**

- 62.00126.01** Inox / *Stainless steel*  
5° Rosa nera - Alta velocità - Linea di fede bianca BU6  
*5° Black card - high speed - White lubber line BU6*
- 62.00125.01** Inox / *Stainless steel*  
5° Rosa nera - Linea di fede bianca BU6  
*5° Black card - White lubber line BU6*
- 62.00128.01** Inox / *Stainless steel*  
5° Rosa nera - Alta velocità - Linea di fede rossa BU7  
*5° Black card - high speed - Red lubber line BU7*
- 62.00127.01** Inox / *Stainless steel*  
5° Rosa nera - Linea di fede rossa BU7  
*5° Black card - Red lubber line BU7*

Rosa 5° / *Card graduations 5°*

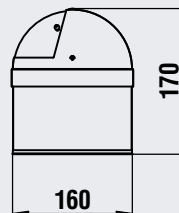
Rosa (blu 5° / nera 5°)  
Copertura telescopica.  
Completamente smontabili e riparabili.  
Compensazione incorporata.

*Card (Blue 5° / black 5°)*  
*Telescopic cover. Repairable.*  
*Built-in compensation.*

Rosa 5° / *Card graduations 5°*Rosa 5° / *Card graduations 5°***Accessori / Accessories**

Coperchio di protezione inox  
*Protective cover stainless steel*

**COD. ORDINAZIONE / ORDER COD.**  
**62.00156.01**



DM 588/200 incluso.  
Certificato MED su richiesta.  
Certificazione tipo approvato RINA su richiesta.

*DM 588/200 included.*  
*MED certificate on request*  
*RINA certification approved, on request.*



## BU5

Su richiesta *On request*



## BU4

Su richiesta *On request*



### BU5 installazione a chiesuola / *Binnacle mounted*

#### CARATTERISTICHE / *KEY FEATURES*

Sospensione:	Cardanica interna
<i>Gimbal type:</i>	<i>Internally gimbaled</i>
Illuminazione:	12V di serie (24V a richiesta)
<i>Lighting:</i>	<i>12V standard (24V on request)</i>
Letture:	Posteriore - linea di fede rossa
<i>Reading:</i>	<i>Rear - red lubber line</i>
Divisione rosa:	5° - 2°
<i>Card graduations:</i>	<i>5° - 2°</i>
Diametro apparente:	4" - 100 mm
<i>Apparent card dia:</i>	<i>4" - 100 mm</i>

#### CODICI ORDINAZIONE / *ORDER CODES*

**62.00158.01** Nera 5° Rosa nera - Alta velocità / *Black 5° Black card - high speed*

**62.00158.10** Nera 5° Rosa rossa - Alta velocità / *Black 5° Red card - high speed*

**62.00112.01** Nera 5° Rosa nera / *Black 5° Black card*

**62.00157.01** Nera 2° Rosa nera / *Black 2° Black card*

**62.00103.01** Bianca 5° Rosa nera / *White 5° Black card*



Rosa 5° / *Card graduations 5°*



Rosa 2° / *Card graduations 2°*

### BU4 installazione a chiesuola / *Binnacle mounted*

#### CARATTERISTICHE / *KEY FEATURES*

Sospensione:	Cardanica interna
<i>Gimbal type:</i>	<i>Internally gimbaled</i>
Illuminazione:	12V di serie (24V a richiesta)
<i>Lighting:</i>	<i>12V standard (24V on request)</i>
Letture:	Posteriore - linea di fede rossa
<i>Reading:</i>	<i>Rear - red lubber line</i>
Divisione rosa:	5° - 2°
<i>Card graduations:</i>	<i>5° - 2°</i>
Diametro apparente:	4" - 100 mm
<i>Apparent card dia:</i>	<i>4" - 100 mm</i>

#### CODICI ORDINAZIONE / *ORDER CODES*

**62.00042.01** Nera 5° Rosa nera - Alta velocità / *Black 5° Black card - high speed*

**62.00042.10** Nera 5° Rosa rossa - Alta velocità / *Black 5° Red card - high speed*

**62.00041.01** Nera 5° Rosa nera / *Black 5° Black card*

**62.00150.01** Nera 2° Rosa nera / *Black 2° Black card*

**62.00507.01** Bianca 5° Rosa bianca / *White 5° White card*

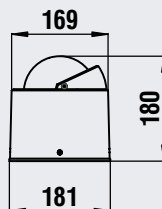
### Accessori / *Accessories*



Calotta di protezione in tela

*Protective cover  
Canvas hood*

**COD. ORDINAZIONE / *ORDER COD.***  
**62.00062.01**



DM 588/200 incluso.  
Certificato MED su richiesta.  
Certificazione tipo approvato RINA su richiesta.

*DM 588/200 included.  
MED certificate on request  
RINA certification approved, on request.*

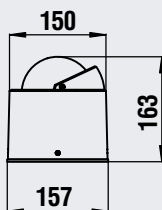
### Accessori / *Accessories*



Calotta di protezione in tela

*Protective cover  
Canvas hood*

**COD. ORDINAZIONE / *ORDER COD.***  
**62.00063.01**



DM 588/200 incluso.  
Certificato MED su richiesta.  
Certificazione tipo approvato RINA su richiesta.

*DM 588/200 included.  
MED certificate on request  
RINA certification approved, on request.*



**BU2**  
Su richiesta *On request*



## BU2 installazione a chiesuola / *Binnacle mounted*

### CARATTERISTICHE / *KEY FEATURES*

Sospensione:	Cardanica interna
<i>Gimbal type:</i>	<i>Internally gimballed</i>
Illuminazione:	12V di serie (24V a richiesta)
<i>Lighting:</i>	<i>12V standard (24V on request)</i>
Letture:	Posteriore - linea di fede rossa
<i>Reading:</i>	<i>Rear - red lubber line</i>
Divisione rosa:	5° - 2°
<i>Card graduations:</i>	<i>5° - 2°</i>
Diametro apparente:	4" - 100 mm
<i>Apparent card dia:</i>	<i>4" - 100 mm</i>

### CODICI ORDINAZIONE / *ORDER CODES*

**62.00038.01** Nera 5° Rosa nera - Alta velocità / *Black 5° Black card - high speed*

**62.00038.10** Nera 5° Rosa rossa - Alta velocità / *Black 5° Red card - high speed*

**62.00037.01** Nera 5° Rosa nera / *Black 5° Black card*

**62.00152.01** Nera 2° Rosa nera / *Black 2° Black card*

**62.00506.01** Bianca 5° Rosa bianca / *White 5° White card*



Rosa 5° / *Card graduations 5°*



Rosa 2° / *Card graduations 2°*

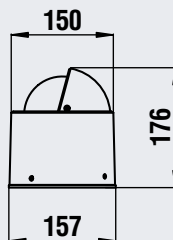
## Accessori / *Accessories*



Calotta di protezione in tela

*Protective cover  
Canvas hood*

**COD. ORDINAZIONE / *ORDER COD.***  
**62.00063.01**



DM 588/200 incluso.  
Certificato MED su richiesta.  
Certificazione tipo approvato RINA su richiesta.

*DM 588/200 included.  
MED certificate on request  
RINA certification approved, on request.*





BU8



BU10



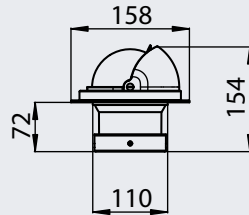
**BU8 installazione ad incasso orizzontale / Horizontal flush mounted**

**CARATTERISTICHE / KEY FEATURES**

Sospensione:	Cardanica interna
<i>Gimbal type:</i>	<i>Internally gimbaled</i>
Illuminazione:	LED 12V di serie (LED 24V a richiesta)
<i>Lighting:</i>	<i>LED 12V standard (LED 24V on request)</i>
Letture:	Posteriore - linea di fede rossa
<i>Reading:</i>	<i>Rear - red lubber line</i>
Divisione rosa:	5°
<i>Card graduations:</i>	<i>5°</i>
Diametro apparente:	4" - 100 mm
<i>Apparent card dia:</i>	<i>4" - 100 mm</i>

**CODICI ORDINAZIONE / ORDER CODES**

- 62.00652.10** Nera 5° Rosa nera - Alta velocità - con copertura  
*Black 5° Black card - high speed - whit Protective cover*
- 62.00652.11** Bianca 5° Rosa nera - Alta velocità - con copertura  
*White 5° Black card - high speed - whit Protective cover*
- 62.00652.30** Bianca 5° Rosa blu - Alta velocità - con copertura  
*White 5° Blue card - high speed - whit Protective cover*
- 62.00652.00** Nera 5° Rosa nera - con copertura  
*Black 5° Black card - whit Protective cover*
- 62.00652.01** Bianca 5° Rosa nera - con copertura  
*White 5° Black card - whit Protective cover*
- 62.00652.03** Bianca 5° Rosa blu - con copertura  
*White 5° Blue card - whit Protective cover*



Quadrante disponibile nero o blu.  
Copertura telescopica.  
Completamente smontabili e riparabili.  
Compensazione incorporata.

*Black or blue card available. Telescopic cover.  
Repairable. Built-in compensation.*



Rosa 5° / Card graduations 5°



Rosa 5° / Card graduations 5°

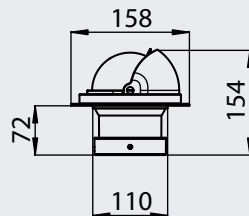
**BU10 installazione ad incasso orizzontale / Horizontal flush mounted**

**CARATTERISTICHE / KEY FEATURES**

Sospensione:	Cardanica interna
<i>Gimbal type:</i>	<i>Internally gimbaled</i>
Illuminazione:	LED 12V di serie (LED 24V a richiesta)
<i>Lighting:</i>	<i>LED 12V standard (LED 24V on request)</i>
Letture:	Frontale - linea di fede rossa
<i>Reading:</i>	<i>Direct - red lubber line</i>
Divisione rosa:	5°
<i>Card graduations:</i>	<i>5°</i>
Diametro apparente:	4" - 100 mm
<i>Apparent card dia:</i>	<i>4" - 100 mm</i>

**CODICI ORDINAZIONE / ORDER CODES**

- 62.00744.00** Nera 5° Rosa nera - Alta velocità - con copertura  
*Black 5° Black card - high speed - whit Protective cover*
- 62.00744.01** Bianca 5° Rosa nera - Alta velocità - con copertura  
*White 5° Black card - high speed - whit Protective cover*
- 62.00744.02** Bianca 5° Rosa blu - Alta velocità - con copertura  
*White 5° Blue card - high speed - whit Protective cover*
- 62.00744.03** Nera 5° Rosa blu - Alta velocità - con copertura  
*Black 5° Blue card - high speed - whit Protective cover*



Quadrante disponibile nero o blu.  
Copertura telescopica.  
Completamente smontabili e riparabili.  
Compensazione incorporata.

*Black or blue card available. Anti-glare screen  
repairable. Built-in compensation.*



Nero / Black



Blu / Blue



### BU3

Su richiesta *On request*



### BU1

Su richiesta *On request*



## BU3 installazione ad incasso orizzontale / Horizontal flush mounted

### CARATTERISTICHE / KEY FEATURES

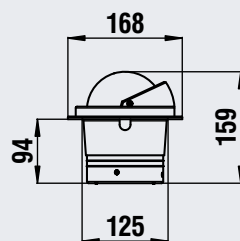
Sospensione:	Cardanica interna
<i>Gimbal type:</i>	<i>Internally gimbaled</i>
Illuminazione:	12V di serie (24V a richiesta)
<i>Lighting:</i>	<i>12V standard (24V on request)</i>
Letture:	Posteriore - linea di fede rossa
<i>Reading:</i>	<i>Rear - red lubber line</i>
Divisione rosa:	5° - 2°
<i>Card graduations:</i>	<i>5° - 2°</i>
Diametro apparente:	4" - 100 mm
<i>Apparent card dia:</i>	<i>4" - 100 mm</i>

### CODICI ORDINAZIONE / ORDER CODES

- 62.00040.01** Nera 5° Rosa nera - Alta velocità / *Black 5° Black card - high speed*
- 62.00040.10** Nera 5° Rosa rossa - Alta velocità / *Black 5° Red card - high speed*
- 62.00039.01** Nera 5° Rosa nera / *Black 5° Black card*
- 62.00153.01** Nera 2° Rosa nera / *Black 2° Black card*
- 62.00321.01** Bianca 5° Rosa blu - Alta velocità / *White 5° Blue card - high speed*



Rosa 5° / *Card graduations 5°*



DM 588/200 incluso.  
Certificato MED su richiesta.  
Certificazione tipo approvato RINA su richiesta.

*DM 588/200 included.*  
*MED certificate on request*  
*RINA certification approved, on request.*

## BU1 installazione ad incasso orizzontale / Horizontal flush mounted

### CARATTERISTICHE / KEY FEATURES

Sospensione:	Cardanica interna
<i>Gimbal type:</i>	<i>Internally gimbaled</i>
Illuminazione:	12V di serie (24V a richiesta)
<i>Lighting:</i>	<i>12V standard (24V on request)</i>
Letture:	Posteriore - linea di fede rossa
<i>Reading:</i>	<i>Rear - red lubber line</i>
Divisione rosa:	5° - 2°
<i>Card graduations:</i>	<i>5° - 2°</i>
Diametro apparente:	4" - 100 mm
<i>Apparent card dia:</i>	<i>4" - 100 mm</i>

### CODICI ORDINAZIONE / ORDER CODES

- 62.00036.01** Nera 5° Rosa nera - Alta velocità / *Black 5° Black card - high speed*
- 62.00036.10** Nera 5° Rosa rossa - Alta velocità / *Black 5° Red card - high speed*
- 62.00035.01** Nera 5° Rosa nera / *Black 5° Black card*
- 62.00151.01** Nera 2° Rosa nera / *Black 2° Black card*
- 62.00318.01** Bianca 5° Rosa bianca / *White 5° White card*



Rosa 2° / *Card graduations 2°*

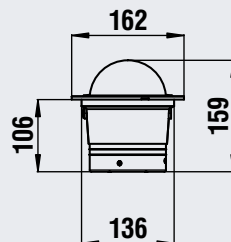
## Accessori / Accessories



Coperchio di protezione bianco

*Protective cover*  
*Canvas hood*

### COD. ORDINAZIONE / ORDER COD. 62.00048.01



DM 588/200 incluso.  
Certificato MED su richiesta.  
Certificazione tipo approvato RINA su richiesta.

*DM 588/200 included.*  
*MED certificate on request*  
*RINA certification approved, on request.*





# Riviera

**BUSSOLE MAGNETICHE  
MAGNETIC COMPASSES**

---



**ASTRA SERIES 4"**



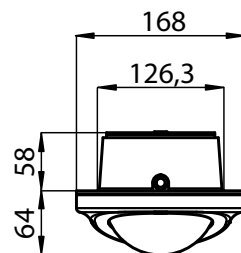
## BUSSOLE MAGNETICHE / MAGNETIC COMPASSES

SERIE ASTRA 4" / ASTRA SERIES 4"

### CARATTERISTICHE GENERALI / STANDARD FEATURES

- **Diametro apparente: 4" (100 mm)**  
*Apparent diameter: 4" (100 mm)*
- **Sospensione cardanica interna**  
*Internal gimbal*
- **Letture frontale**  
*Direct reading*
- **LED 12V di serie (LED 24V a richiesta)**  
*LED 12V standard (LED 24V on request)*
- **Accessibili internamente in caso di riparazione**  
*Repairability*
- **Rosa nera con gradazione di 5°**  
*Black card, 5° graduation*

### BAS1



Bussola magnetica installazione ad incasso a soffitto  
*Over head horizontal flush mounted magnetic compass*



SPONSOR - Ocean Rib Experience 2017



**BAS1 installazione ad incasso a soffitto / Over head flush mounted**

**CARATTERISTICHE / KEY FEATURES**

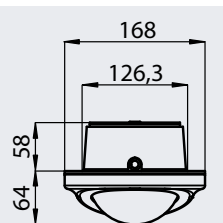
Sospensione:	cardanica interna
<i>Gimbal type:</i>	<i>Internally gimbaled</i>
Illuminazione:	LED 12V di serie (LED 24V a richiesta)
<i>Lighting:</i>	<i>LED 12V standard (LED 24V on request)</i>
Lettura:	Frontale
<i>Reading:</i>	<i>Direct</i>
Divisione rosa:	5°
<i>Card graduations:</i>	<i>5°</i>
Diametro apparente:	4" - 100 mm
<i>Apparent card dia:</i>	<i>4" - 100 mm</i>

**CODICI ORDINAZIONE / ORDER CODES**

**62.00854.00** Nera Rosa nera / *Black Black card*

Su richiesta disponibile nel colore bianco / *On request white colour available*

Rosa 5° / *Card graduations 5°*



Quadrante nero.  
Schermo antiriflesso.  
Completamente smontabili e riparabili.  
Compensazione incorporata.

*Black Card.  
Anti-Glare Screen.  
Repairable.  
Built-In Compensation.*







# Riviera

**BUSSOLE MAGNETICHE  
MAGNETIC COMPASSES**

---



**PEGASUS SERIE S 3" 4"**



## CARATTERISTICHE GENERALI / STANDARD FEATURES

- **Diametro apparente: 3" (80 mm) - 4" (100 mm)**  
*Apparent diameter: 3" (80mm) - 4" (100 mm)*
- **Sospensione cardanica interna**  
*Internal gimbal*
- **LED 12V di serie (LED 24V a richiesta)**  
*LED 12V standard (LED 24V on request)*
- **Letture frontale**  
*Direct reading*
- **Provviste di inclinometro di serie**  
*Standard inclinometer*
- **Accessibili internamente in caso di riparazione**  
*Repairability*
- **Rosa nera/bianca/blu/rossa con gradazione di 5°**  
*Black/white/blue/red card, 5° graduation*
- **Installazione ad incasso verticale**  
*Bulk head mount*



**NON NECESSITA DI OMOLOGAZIONE PER NAVIGAZIONE ENTRO LE 6 MIGLIA**  
**NO APPROVALS NEEDED FOR NAVIGATION WITHIN 6 MILES**

## OMOLOGAZIONI E CERTIFICATI / HOMOLOGATIONS AND CERTIFICATES



44 PEGASUS SERIE S 3" 4"

Su richiesta *On request*

● Certificato MED in accordo con la direttiva MED 2014/90/EU riguardo alle imbarcazioni di salvataggio e battelli di emergenza.

● MED Certification According to the directive MED 2014/90/EU, regarding lifeboats and rescue boats





**BP1**

Su richiesta  
On request



TUTTE LE BUSSOLE SONO DOTATE DI COPERTURA / ALL COMPASSES HAVE THE PROTECTION COVER INCLUDED

**BP1 PEGASUS 3" installazione ad incasso verticale / Bulkhead mounted**

**CARATTERISTICHE / KEY FEATURES**

Sospensione <i>Gimbal type:</i>	Cardanica interna <i>Internally gimballed</i>
Illuminazione <i>Lighting:</i>	LED 12V di serie (LED 24V a richiesta) <i>LED 12V standard (LED 24V on request)</i>
Lettura <i>Reading:</i>	Frontale <i>Direct</i>
Divisione rosa <i>Card graduations:</i>	5° 5°
Dia. apparente <i>Apparent card dia:</i>	3" - 80 mm 3" - 80 mm

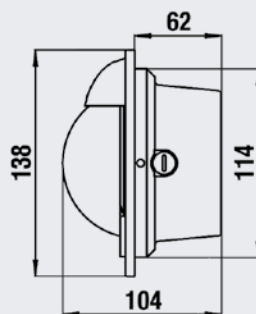
**Accessori / Accessories**



Capotta di protezione / *Protection cover*  
**COD. ORDINAZIONE / ORDER COD.**  
**60.03272.10**

**CODICI ORDINAZIONE / ORDER CODES**

- 62.00785.00** Bianca Rosa nera / *White Black card*
- 62.00785.01** Bianca Rosa bianca / *White White card*
- 62.00785.02** Bianca Rosa rossa / *White Red card*
- 62.00785.03** Bianca Rosa blu / *White Blue card*
- 62.00785.04** Nera Rosa nera / *Black Black card*
- 62.00785.05** Nera Rosa bianca / *Black White card*
- 62.00785.06** Nera Rosa rossa / *Black Red card*
- 62.00785.07** Nera Rosa blu / *Black Blue card*



Certificato MED su richiesta

*MED certification on request*



Rosa 5° / *Card graduations 5°*



**45 PEGASUS SERIES 3" 4"**

**BP2**Su richiesta  
On request

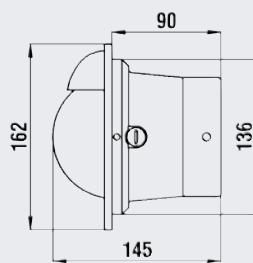
TUTTE LE BUSSOLE SONO DOTATE DI COPERTURA / ALL COMPASSES HAVE THE PROTECTION COVER INCLUDED

**BP2 PEGASUS 4" installazione ad incasso verticale / Bulkhead mounted****Accessori / Accessories****CARATTERISTICHE / KEY FEATURES**

Sospensione <i>Gimbal type:</i>	Cardanica interna <i>Internally gimbaled</i>
Illuminazione <i>Lighting:</i>	LED 12V di serie (LED 24V a richiesta) <i>LED 12V standard (LED 24V on request)</i>
Lettura <i>Reading:</i>	Frontale <i>Direct</i>
Divisione rosa <i>Card graduations:</i>	5° <i>5°</i>
Dia. apparente <i>Apparent card dia:</i>	4" - 100 mm <i>4" - 100 mm</i>

Calotta di protezione / *Protection cover*  
**COD. ORDINAZIONE / ORDER COD.**  
**60.03259.00****CODICI ORDINAZIONE / ORDER CODES**

- 62.00773.00** Bianca Rosa nera / *White Black card*
- 62.00773.01** Bianca Rosa bianca / *White White card*
- 62.00773.04** Bianca Rosa rossa / *White Red card*
- 62.00773.05** Bianca Rosa blu / *White Blue card*
- 62.00773.02** Nera Rosa nera / *Black Black card*
- 62.00773.03** Nera Rosa bianca / *Black White card*
- 62.00773.06** Nera Rosa rossa / *Black Red card*
- 62.00773.07** Nera Rosa blu / *Black Blue card*

Certificato MED su richiesta  
*MED certification on request*Rosa 5° / *Card graduations 5°*



# Riviera

**BUSSOLE MAGNETICHE  
MAGNETIC COMPASSES**

---



**POLARE SERIES 3" 4"**



## CARATTERISTICHE GENERALI / STANDARD FEATURES

- **Diametro apparente: 3" (80 mm) - 4" (100 mm)**  
*Apparent diameter: 3" (80mm) - 4" (100 mm)*
- **Sospensione cardanica interna**  
*Internal gimbal*
- **LED 12V di serie (LED 24V a richiesta)**  
*LED 12V standard (LED 24V on request)*
- **Letture frontale**  
*Direct reading*
- **Provviste di inclinometro di serie**  
*Standard inclinometer*
- **Accessibili internamente in caso di riparazione**  
*Repairability*
- **Rosa nera/bianca/blu/rossa con gradazione di 5°**  
*Black/white/blue/red card, 5° graduation*
- **Installazione ad incasso verticale**  
*Bulk head mount*



**NON NECESSITA DI OMOLOGAZIONE PER NAVIGAZIONE ENTRO LE 6 MIGLIA**  
**NO APPROVALS NEEDED FOR NAVIGATION WITHIN 6 MILES**

## OMOLOGAZIONI E CERTIFICATI / HOMOLOGATIONS AND CERTIFICATES



Su richiesta *On request*

● Certificato MED  
in accordo con la direttiva MED  
2014/90/EU riguardo alle imbarcazioni di  
salvataggio e battelli di emergenza.

● MED Certification  
According to the directive MED 2014/90/  
EU, regarding lifeboats and rescue boats





**BP1**  
Su richiesta  
On request



## BP1 POLARE 3" installazione ad incasso verticale / Bulkhead mounted

### CARATTERISTICHE / KEY FEATURES

Sospensione <i>Gimbal type:</i>	Cardanica interna <i>Internally gimbaled</i>
Illuminazione <i>Lighting:</i>	LED 12V di serie (LED 24V a richiesta) <i>LED 12V standard (LED 24V on request)</i>
Letture <i>Reading:</i>	Frontale <i>Direct</i>
Divisione rosa <i>Card graduations:</i>	5° 5°
Dia. apparente <i>Apparent card dia:</i>	3" - 80 mm 3" - 80 mm

### CODICI ORDINAZIONE / ORDER CODES

- 62.00043.05** Nera Rosa bianca / *Black White card*
- 62.00043.02** Nera Rosa nera / *Black Black card*
- 62.00043.03** Nera Rosa rossa / *Black Red card*
- 62.00043.04** Nera Rosa blu / *Black Blue card*
- 62.00508.01** Bianca Rosa bianca / *White White card*
- 62.00508.02** Bianca Rosa nera / *White Black card*
- 62.00508.03** Bianca Rosa rossa / *White Red card*
- 62.00508.04** Bianca Rosa blu / *White Blue card*



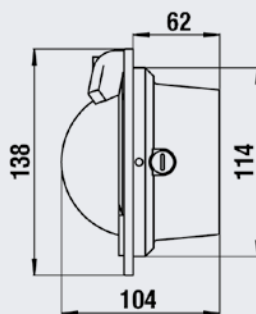
Rosa 5° / *Card graduations 5°*

## Accessori / Accessories



Coperchio di protezione bianco  
*Protective cover Canvas hood*

**COD. ORDINAZIONE / ORDER COD.**  
**62.00047.01**



Certificato MED su richiesta

*MED certification on request*







**BP2**  
Su richiesta  
On request



## BP2 POLARE 4" installazione ad incasso verticale / Bulkhead mounted

## Accessori / Accessories

### CARATTERISTICHE / KEY FEATURES

Sospensione <i>Gimbal type:</i>	Cardanica interna <i>Internally gimbaled</i>
Illuminazione <i>Lighting:</i>	LED 12V di serie (LED 24V a richiesta) <i>LED 12V standard (LED 24V on request)</i>
Lettura <i>Reading:</i>	Frontale <i>Direct</i>
Divisione rosa <i>Card graduations:</i>	5° <i>5°</i>
Dia. apparente <i>Apparent card dia:</i>	4" - 100 mm <i>4" - 100 mm</i>

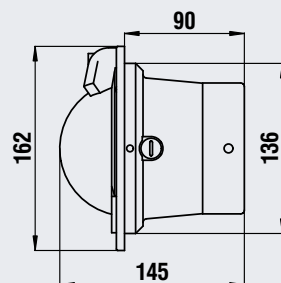


Coperchio di protezione bianco  
*Protective cover Canvas hood*

**COD. ORDINAZIONE / ORDER COD.**  
**62.00048.01**

### CODICI ORDINAZIONE / ORDER CODES

- 62.00044.05** Nera Rosa bianca / *Black White card*
- 62.00044.02** Nera Rosa nera / *Black Black card*
- 62.00044.03** Nera Rosa rossa / *Black Red card*
- 62.00044.04** Nera Rosa blu / *Black Blue card*
- 62.00509.01** Bianca Rosa bianca / *White White card*
- 62.00509.02** Bianca Rosa nera / *White Black card*
- 62.00509.03** Bianca Rosa rossa / *White Red card*
- 62.00509.04** Bianca Rosa blu / *White Blue card*



Certificato MED su richiesta

*MED certification on request*



Rosa 5° / *Card graduations 5°*



# Riviera

**BUSSOLE MAGNETICHE  
MAGNETIC COMPASSES**

---



**IDRA SERIES 3"**



## BUSSELE MAGNETICHE / MAGNETIC COMPASSES

SERIE IDRA 3" / IDRA SERIES 3"

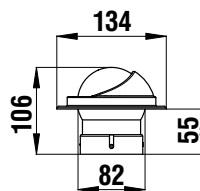
### CARATTERISTICHE GENERALI / STANDARD FEATURES

- **Diametro apparente: 3" (80 mm)**  
*Apparent diameter: 3" (80 mm)*
- **Sospensione semi cardanica interna**  
*Half internal gimbal*
- **Compensazione incorporata**  
*Built-in compensation*
- **Letture frontale**  
*Direct reading*
- **LED 12V di serie (LED 24V a richiesta)**  
*LED 12V standard (LED 24V on request)*
- **Accessibili internamente in caso di riparazione**  
*Repairability*
- **Rosa nera con gradazione di 5°**  
*Black card, 5° graduation*



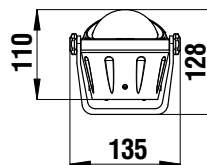
**NON NECESSITA DI OMOLOGAZIONE PER NAVIGAZIONE ENTRO LE 6 MIGLIA**  
**NO APPROVALS NEEDED FOR NAVIGATION WITHIN 6 MILES**

### B11



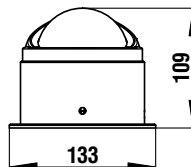
Bussola magnetica installazione a inc. orizzontale  
*Horizontal flush mounted magnetic compass*

### B12



Bussola magnetica installazione con supporto a staffa  
*Bracket mounted magnetic compass*

### B13



Bussola magnetica installazione a chiesuola  
*Binnacle mounted magnetic compass*



### B11 installazione ad incasso orizzontale / Horizontal flush mounted

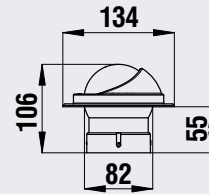
#### CARATTERISTICHE / KEY FEATURES

Sospensione:	Semi-cardanica interna
<i>Gimbal type:</i>	<i>Half internally gimballed</i>
Illuminazione:	LED 12V di serie (LED 24V a richiesta)
<i>Lighting:</i>	<i>LED 12V standard (LED 24V on request)</i>
Letture:	Frontale
<i>Reading:</i>	<i>Direct</i>
Divisione rosa:	5°
<i>Card graduations:</i>	<i>5°</i>
Diametro apparente:	3" - 80 mm
<i>Apparent card dia:</i>	<i>3" - 80 mm</i>

#### CODICI ORDINAZIONE / ORDER CODES

**62.00778.00** Nera Rosa nera / *Black Black card*

**62.00778.01** Bianca Rosa nera / *White Black card*



Quadrante nero.  
Schermo antiriflesso.  
Completamente smontabili e riparabili.  
Compensazione incorporata.

*Black Card.*  
*Anti-Glare Screen.*  
*Repairable.*  
*Built-In Compensation.*



Rosa 5° / *Card graduations 5°*



**B12****B13****B12 installazione a staffa / Bracket mounted****CARATTERISTICHE / KEY FEATURES**

Sospensione:	Semi-cardanica interna
<i>Gimbal type:</i>	<i>Half internally gimbaled</i>
Illuminazione:	LED 12V di serie (LED 24V a richiesta)
<i>Lighting:</i>	<i>LED 12V standard (LED 24V on request)</i>
Lettura:	Frontale
<i>Reading:</i>	<i>Direct</i>
Divisione rosa:	5°
<i>Card graduations:</i>	<i>5°</i>
Diametro apparente:	3" - 80 mm
<i>Apparent card dia:</i>	<i>3" - 80 mm</i>

**CODICI ORDINAZIONE / ORDER CODES**

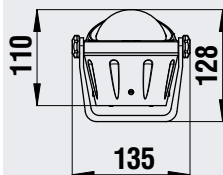
- 62.00779.00** Nera Rosa nera / *Black Black card*  
**62.00779.01** Bianca Rosa nera / *White Black card*

Rosa 5° / *Card graduations 5°***B13 installazione a chiesuola / Binnacle mounted****CARATTERISTICHE / KEY FEATURES**

Sospensione:	Semi-cardanica interna
<i>Gimbal type:</i>	<i>Half internally gimbaled</i>
Illuminazione:	LED 12V di serie (LED 24V a richiesta)
<i>Lighting:</i>	<i>LED 12V standard (LED 24V on request)</i>
Lettura:	Frontale
<i>Reading:</i>	<i>Direct</i>
Divisione rosa:	5°
<i>Card graduations:</i>	<i>5°</i>
Diametro apparente:	3" - 80 mm
<i>Apparent card dia:</i>	<i>3" - 80 mm</i>

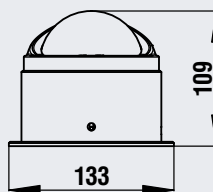
**CODICI ORDINAZIONE / ORDER CODES**

- 62.00780.00** Nera Rosa nera / *Black Black card*  
**62.00780.01** Bianca Rosa nera / *White Black card*



Quadrante nero.  
 Schermo antiriflesso.  
 Completamente smontabili e riparabili.  
 Compensazione incorporata.

*Black Card.*  
*Anti-Glare Screen.*  
*Repairable.*  
*Built-In Compensation.*



Quadrante nero.  
 Schermo antiriflesso.  
 Completamente smontabili e riparabili.  
 Compensazione incorporata.

*Black Card.*  
*Anti-Glare Screen.*  
*Repairable.*  
*Built-In Compensation.*





# Riviera

**BUSSOLE MAGNETICHE  
MAGNETIC COMPASSES**

---



**PHOENIX SERIES 3"**



## BUSSOLE MAGNETICHE / MAGNETIC COMPASSES

### SERIE PHOENIX 3" / PHOENIX SERIES 3"

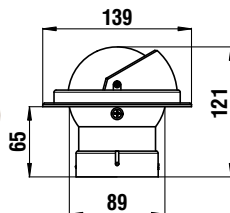
#### CARATTERISTICHE GENERALI / STANDARD FEATURES

- **Diametro apparente: 3" (80 mm)**  
*Apparent diameter: 3" (80 mm)*
- **Lettura frontale**  
*Direct reading*
- **Sospensione cardanica interna**  
*Internal gimbal*
- **Compensazione incorporata**  
*Built-in compensation*
- **LED 12V di serie (LED 24V a richiesta)**  
*LED 12V standard (LED 24V on request)*
- **Schermo antiriflesso**  
*Anti-glare screen*
- **Accessibili internamente in caso di riparazione**  
*Repairability*
- **Versione "normale" e "alta velocità" (V25 nodi)**  
*"Standard" and "high speed" version (S.25 knots)*
- **Rosa nera/blu con gradazione di 5°**  
*Black/blue card, 5° graduation*



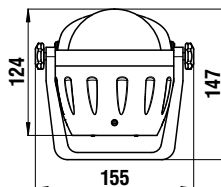
**NON NECESSITA DI OMOLOGAZIONE PER NAVIGAZIONE ENTRO LE 6 MIGLIA**  
**NO APPROVALS NEEDED FOR NAVIGATION WITHIN 6 MILES**

### BPH1



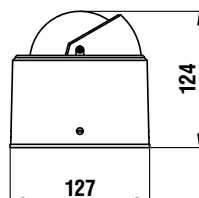
Bussola magnetica installazione a inc. orizzontale  
*Horizontal flush mounted magnetic compass*

### BPH2



Bussola magnetica installazione con supporto a staffa  
*Bracket mounted magnetic compass*

### BPH3



Bussola magnetica installazione a chiesuola  
*Binnacle mounted magnetic compass*



**BPH1**



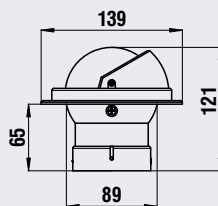
## BPH1 installazione ad incasso orizzontale / Horizontal flush mounted

### CARATTERISTICHE / KEY FEATURES

Sospensione:	Cardanica interna
<i>Gimbal type:</i>	<i>Internally gimbaled</i>
Illuminazione:	LED 12V di serie (LED 24V a richiesta)
<i>Lighting:</i>	<i>LED 12V standard (LED 24V on request)</i>
Letture:	Frontale
<i>Reading:</i>	<i>Direct</i>
Divisione rosa:	5°
<i>Card graduations:</i>	<i>5°</i>
Diametro apparente:	3" - 80 mm
<i>Apparent card dia:</i>	<i>3" - 80 mm</i>

### CODICI ORDINAZIONE / ORDER CODES

- 62.00444.01** Nera Rosa nera - Alta velocità / *Black Black card - high speed*
- 62.00445.01** Nera Rosa nera / *Black Black card*
- 62.00444.02** Bianca Rosa nera - Alta velocità / *White Black card - high speed*
- 62.00445.02** Bianca Rosa nera / *White Black card*
- 62.00444.03** Grigia Rosa blu - Alta velocità / *Grey Blue card - high speed*
- 62.00445.03** Grigia Rosa blu / *Grey Blue card*



Quadrante nero o blu.  
Schermo antiriflesso.  
Completamente smontabili e riparabili.  
Compensazione incorporata.

*Black or blue card available.  
Anti-glare screen.  
Repairable.  
Built-in compensation.*



Rosa 5° / *Card graduations 5°*



Rosa 5° / *Card graduations 5°*



**BPH3****BPH2****BPH3 installazione a chiesuola / Binnacle mounted****CARATTERISTICHE / KEY FEATURES**

Sospensione:	Cardanica interna
<i>Gimbal type:</i>	<i>Internally gimbale</i>
Illuminazione:	LED 12V di serie (LED 24V a richiesta)
<i>Lighting:</i>	<i>LED 12V standard (LED 24V on request)</i>
Lettura:	Frontale
<i>Reading:</i>	<i>Direct</i>
Divisione rosa:	5°
<i>Card graduations:</i>	<i>5°</i>
Diametro apparente:	3" - 80 mm
<i>Apparent card dia:</i>	<i>3" - 80 mm</i>

**CODICI ORDINAZIONE / ORDER CODES**

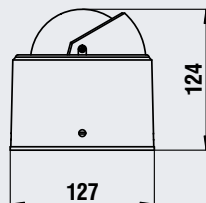
- 62.00448.01** Nera Rosa nera - Alta velocità / *Black Black card - high speed*
- 62.00449.01** Nera Rosa nera / *Black Black card*
- 62.00448.02** Bianca Rosa nera - Alta velocità / *White Black card - high speed*
- 62.00449.02** Bianca Rosa nera / *White Black card*
- 62.00448.03** Grigia Rosa blu - Alta velocità / *Grey Blue card - high speed*
- 62.00449.03** Grigia Rosa blu / *Grey blue card*

Rosa 5° / *Card graduations 5°*Rosa 5° / *Card graduations 5°***BPH2 installazione a staffa / Bracket mounted****CARATTERISTICHE / KEY FEATURES**

Sospensione:	Cardanica interna
<i>Gimbal type:</i>	<i>Internally gimbale</i>
Illuminazione:	LED 12V di serie (LED 24V a richiesta)
<i>Lighting:</i>	<i>LED 12V standard (LED 24V on request)</i>
Lettura:	Frontale
<i>Reading:</i>	<i>Direct</i>
Divisione rosa:	5°
<i>Card graduations:</i>	<i>5°</i>
Diametro apparente:	3" - 80 mm
<i>Apparent card dia:</i>	<i>3" - 80 mm</i>

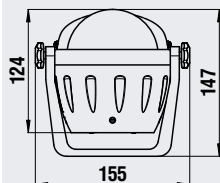
**CODICI ORDINAZIONE / ORDER CODES**

- 62.00446.01** Nera Rosa nera - Alta velocità / *Black Black card - high speed*
- 62.00447.01** Nera Rosa nera / *Black Black card*
- 62.00446.02** Bianca Rosa nera - Alta velocità / *White Black card - high speed*
- 62.00447.02** Bianca Rosa nera / *White Black card*
- 62.00446.03** Grigia Rosa blu - Alta velocità / *Grey Blue card - high speed*
- 62.00447.03** Grigia Rosa blu / *Grey blue card*



Quadrante disponibile nero o blu.  
Schermo antiriflesso.  
Completamente smontabili e riparabili.  
Compensazione incorporata.

*Black Or Blue Card Available.  
Anti-Glare Screen.  
Repairable.  
Built-In Compensation.*



Quadrante disponibile nero o blu.  
Schermo antiriflesso.  
Completamente smontabili e riparabili.  
Compensazione incorporata.

*Black Or Blue Card Available.  
Anti-Glare Screen.  
Repairable.  
Built-In Compensation.*



# Riviera

**BUSSOLE MAGNETICHE  
MAGNETIC COMPASSES**

---



**ZENITH SERIES 3"**

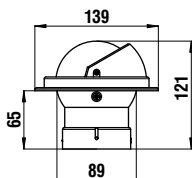




## BUSSOLE MAGNETICHE / MAGNETIC COMPASSES

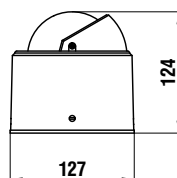
### SERIE ZENITH 3" / ZENITH SERIES 3"

#### BZ1



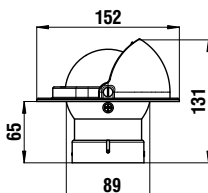
Bussola magnetica installazione a inc. orizzontale  
*Horizontal flush mounted magnetic compass*

#### BZ3



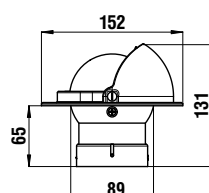
Bussola magnetica installazione a chiesuola  
*Binnacle mounted magnetic compass*

#### BZ1



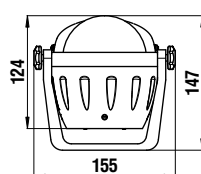
Bussola magnetica installazione a inc. orizzontale  
*Horizontal flush mounted magnetic compass*

#### BZ4



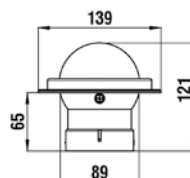
Bussola magnetica installazione a inc. orizzontale  
con copertura  
*Horizontal flush mounted magnetic compass with  
protective cover*

#### BZ2



Bussola magnetica installazione con supporto a staffa  
*Bracket mounted magnetic compass*

#### BZT



Bussola magnetica installazione a inc. orizzontale  
*Horizontal flush mounted magnetic compass*



## CARATTERISTICHE GENERALI / STANDARD FEATURES



- **Diametro apparente: 3" (80 mm)**  
*Apparent diameter: 3" (80 mm)*
- **Sospensione cardanica interna**  
*Internal gimbal*
- **Compensazione incorporata**  
*Built-in compensation*
- **Illuminazione di serie 12V (24V a richiesta)**  
*Standard 12V lighting (24V on request)*
- **Schermo antiriflesso**  
*Anti-glare screen*
- **Accessibili internamente in caso di riparazione**  
*Repairability*
- **Versione "normale" e "alta velocità" (V. 25 nodi)**  
*"Standard" and "high speed" version (S. 25 knots)*
- **Rosa nera/blu con gradazione di 5°**  
*Black/blue card, 5° graduation*



**NON NECESSITA DI OMOLOGAZIONE PER NAVIGAZIONE ENTRO LE 6 MIGLIA**  
**NO APPROVALS NEEDED FOR NAVIGATION WITHIN 6 MILES**

## OMOLOGAZIONI E CERTIFICATI / HOMOLOGATIONS AND CERTIFICATES



Su richiesta On request

Certificato MED in accordo con la direttiva MED 2014/90/EU riguardo alle imbarcazioni di salvataggio e battelli di emergenza.

MED Certification According to the directive MED 2014/90/EU, regarding lifeboats and rescue boats



**BZ3**  
Su richiesta  
On request 



**BZ2**  
Su richiesta  
On request 

### BZ3 installazione a chiesuola / Binnacle mounted

#### CARATTERISTICHE / KEY FEATURES

Sospensione:	Cardanica interna
<i>Gimbal type:</i>	<i>Internally gimbaled</i>
Illuminazione:	12V di serie (24V a richiesta)
<i>Lighting:</i>	<i>12V standard (24V on request)</i>
Lettura:	Posteriore
<i>Reading:</i>	<i>Rear</i>
Divisione rosa:	5°
<i>Card graduations:</i>	<i>5°</i>
Diametro apparente:	3" - 80 mm
<i>Apparent card dia:</i>	<i>3" - 80 mm</i>

#### CODICI ORDINAZIONE / ORDER CODES

- 62.00147.01** Nera Rosa nera - Alta velocità / *Black Black card - high speed*
- 62.00148.01** Nera Rosa nera / *Black Black card*
- 62.00314.01** Grigia Rosa blu - Alta velocità / *Grey Blue card - high speed*
- 62.00315.01** Grigia Rosa blu / *Grey Blue card*
- 62.00314.02** Bianca Rosa nera - Alta velocità / *White Black card - high speed*
- 62.00315.02** Bianca Rosa nera / *White Black card*



Rosa 5° / Card graduations 5°



Rosa 5° / Card graduations 5°

### BZ2 installazione a staffa / Bracket mounted

#### CARATTERISTICHE / KEY FEATURES

Sospensione:	Cardanica interna
<i>Gimbal type:</i>	<i>Internally gimbaled</i>
Illuminazione:	12V di serie (24V a richiesta)
<i>Lighting:</i>	<i>12V standard (24V on request)</i>
Lettura:	Posteriore
<i>Reading:</i>	<i>Rear</i>
Divisione rosa:	5°
<i>Card graduations:</i>	<i>5°</i>
Diametro apparente:	3" - 80 mm
<i>Apparent card dia:</i>	<i>3" - 80 mm</i>

#### CODICI ORDINAZIONE / ORDER CODES

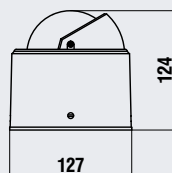
- 62.00145.01** Nera Rosa nera - Alta velocità / *Black Black card - high speed*
- 62.00146.01** Nera Rosa nera / *Black Black card*
- 62.00312.01** Grigia Rosa blu - Alta velocità / *Grey Blue card - high speed*
- 62.00313.01** Grigia Rosa blu / *Grey Blue card*
- 62.00312.02** Bianca Rosa nera - Alta velocità / *White Black card - high speed*
- 62.00313.02** Bianca Rosa nera / *White Black card*

### Accessori / Accessories



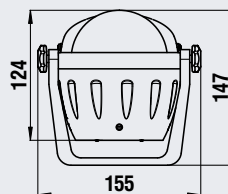
Calotta di protezione in tela  
*Protective cover  
Canvas hood*

**COD. ORDINAZIONE / ORDER COD.**  
**62.00064.01**



Non necessita di omologazione per navigazione entro le 6 miglia. Certificato MED su richiesta. Quadrante disponibile nero o blu. Schermo antiriflesso. Completamente smontabili e riparabili. Compensazione incorporata. Disponibile calotta di protezione in tela.

*No approvals needed for navigation within 6 miles. MED certification on request. Black or blue card available. Anti-glare screen. Repairable. Built-in compensation. Canvas hood available.*



Non necessita di omologazione per navigazione entro le 6 miglia. Certificato MED su richiesta. Quadrante disponibile nero o blu. Schermo antiriflesso. Completamente smontabili e riparabili. Compensazione incorporata. Disponibile calotta di protezione in tela.

*No approvals needed for navigation within 6 miles. MED certification on request. Black or blue card available. Anti-glare screen. Repairable. Built-in compensation. Canvas hood available.*



**BZ1**

Su richiesta / On request



**BZ4**



## BZ1 installazione ad incasso orizzontale / Horizontal flush mounted

### CARATTERISTICHE / KEY FEATURES

Sospensione:	Cardanica interna
<i>Gimbal type:</i>	<i>Internally gimbaled</i>
Illuminazione:	12V di serie (24V a richiesta)
<i>Lighting:</i>	<i>12V standard (24V on request)</i>
Lettura:	Posteriore
<i>Reading:</i>	<i>Rear</i>
Divisione rosa:	5°
<i>Card graduations:</i>	<i>5°</i>
Diametro apparente:	3" - 80 mm
<i>Apparent card dia:</i>	<i>3" - 80 mm</i>

### CODICI ORDINAZIONE / ORDER CODES senza cover protettiva / without protective cover

- 62.00144.01** Nera Rosa nera / *Black Black card*
- 62.00311.01** Grigia Rosa blu / *Grey Blue card*
- 62.00311.02** Bianca Rosa nera / *White Black card*
- 62.00143.01** Nera Rosa nera - Alta velocità / *Black Black card - high speed*
- 62.00309.01** Grigia Rosa blu - Alta velocità / *Grey Blue card - high speed*
- 62.00309.02** Bianca Rosa nera - Alta velocità / *White Black card - high speed*

### CODICI ORDINAZIONE / ORDER CODES con cover protettiva / with protective cover

- 62.00643.00** Nera Rosa nera / *Black Black card*
- 62.00643.02** Grigia Rosa blu / *Grey Blue card*
- 62.00643.01** Bianca Rosa nera / *White Black card*
- 62.00581.00** Nera Rosa nera - Alta velocità / *Black Black card - high speed*
- 62.00581.02** Grigia Rosa blu - Alta velocità / *Grey Blue card - high speed*
- 62.00581.01** Bianca Rosa nera - Alta velocità / *White Black card - high speed*
- 62.00581.03** Bianca Rosa blu - Alta velocità / *White Blue card - high speed*



Rosa 5°  
Card graduations 5°

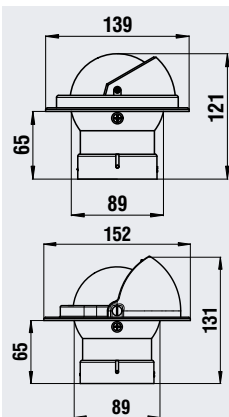
## BZ4 installazione ad incasso orizzontale / Horizontal flush mounted

### CARATTERISTICHE / KEY FEATURES

Sospensione:	A spillo
<i>Gimbal type:</i>	<i>Jewel and pivot movements</i>
Illuminazione:	12V di serie (24V a richiesta)
<i>Lighting:</i>	<i>12V standard (24V on request)</i>
Lettura:	Frontale
<i>Reading:</i>	<i>Direct</i>
Divisione rosa:	5°
<i>Card graduations:</i>	<i>5°</i>
Diametro apparente:	3" - 80 mm
<i>Apparent card dia:</i>	<i>3" - 80 mm</i>

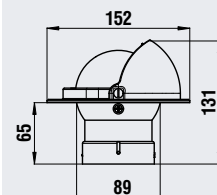
### CODICI ORDINAZIONE / ORDER CODES

- 62.00745.00** Nera Rosa nera - Alta velocità - Con cop. / *Black Black card - high speed - Prot. cover*
- 62.00745.02** Grigia Rosa blu - Alta velocità - Con cop. / *Grey Blue card - high speed - Prot. cover*
- 62.00745.01** Bianca Rosa blu - Alta velocità - Con cop. / *White Blue card - high speed - Prot. cover*
- 62.00745.03** Bianca Rosa nera - Alta velocità - Con cop. / *White Black card - high speed - Prot. cover*



Non necessita di omologazione per navigazione entro le 6 miglia. Certificato MED su richiesta. Quadrante disponibile nero o blu. Schermo antiriflesso. Completamente smontabile e riparabili. Compensazione incorporata.

*No approvals needed for navigation within 6 miles. MED certification on request. Black or blue card available. Anti-glare screen. Built-in compensation.*



Non necessita di omologazione per navigazione entro le 6 miglia. Schermo antiriflesso. Completamente smontabile e riparabili. Compensazione incorporata.

*No approvals needed for navigation within 6 miles. Anti-glare screen. Repairable. Built-in compensation.*



Nero / Black    Blu / Blue



## BZT



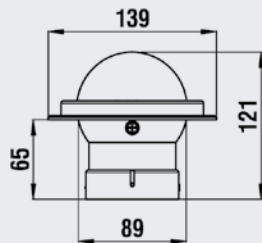
### BZT installazione ad incasso orizzontale / Horizontal flush mounted

#### CARATTERISTICHE / KEY FEATURES

Sospensione:	Cardanica interna
<i>Gimbal type:</i>	<i>Internally gimballed</i>
Letture:	Posteriore e funzione tattica
<i>Reading:</i>	<i>Rear reading and tactical function</i>
Divisione rosa:	5°
<i>Card graduations:</i>	<i>5°</i>
Diametro apparente:	3" - 80 mm
<i>Apparent card dia:</i>	<i>3" - 80 mm</i>

#### CODICI ORDINAZIONE / ORDER CODES

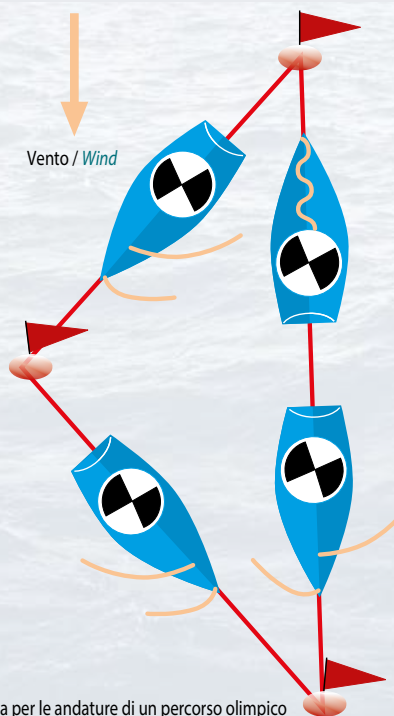
- 62.00772.00** Nera Rosa tattica / *Black Tactical card*
- 62.00772.01** Bianca Rosa tattica / *White Tactical card*
- 62.00772.02** Grigia Rosa tattica / *Grey Tactical card*



Non necessita di omologazione per navigazione entro le 6 miglia  
Schermo antiriflesso.  
Completamente smontabili e riparabili.  
Compensazione incorporata.

*No approvals needed for navigation within 6 miles.  
Anti-glare screen. Repairable.  
Built-in compensation.*

#### Imbarcazioni leggere (inferiori a 9m) / LIGHT BOATS (less than 9 meters)



Una sola cifra per le andature di un percorso olimpico  
*Just 1 number for olympic sailing routers*





# Riviera

**BUSSOLE MAGNETICHE  
MAGNETIC COMPASSES**

---



**ARTICA SERIES 2" 3/4**



## BUSSOLE MAGNETICHE / MAGNETIC COMPASSES

SERIE ARTICA 2" 3/4 / ARTICA SERIES 2" 3/4

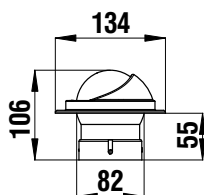
### CARATTERISTICHE GENERALI / STANDARD FEATURES

- **Diametro apparente: 2" 3/4 (70 mm)**  
*Apparent diameter: 2" 3/4 (70 mm)*
- **Sospensione semi-cardanica interna**  
*Half internal gimbal*
- **Compensazione incorporata**  
*Built-in compensation*
- **Illuminazione di serie 12V (24V a richiesta)**  
*Standard 12V lighting (24V on request)*
- **Schermo antiriflesso**  
*Anti-glare screen*
- **Accessibili internamente in caso di riparazione**  
*Repairability*
- **Rosa nera/blu con gradazione di 5°**  
*Black/blue card, 5° graduation*



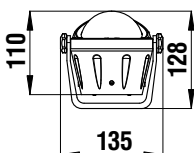
**NON NECESSITA DI OMOLOGAZIONE PER NAVIGAZIONE ENTRO LE 6 MIGLIA**  
**NO APPROVALS NEEDED FOR NAVIGATION WITHIN 6 MILES**

### BA1



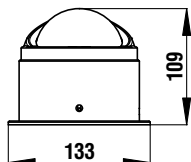
Bussola magnetica installazione a inc. orizzontale  
*Horizontal flush mounted magnetic compass*

### BA2



Bussola magnetica installazione con supporto a staffa  
*Bracket mounted magnetic compass*

### BA3



Bussola magnetica installazione a chiesuola  
*Binnacle mounted magnetic compass*

### OMOLOGAZIONI E CERTIFICATI HOMOLOGATIONS AND CERTIFICATES



Su richiesta *On request*

● **Certificato MED**  
in accordo con la direttiva MED 2014/90/EU riguardo alle imbarcazioni di salvataggio e battelli di emergenza.

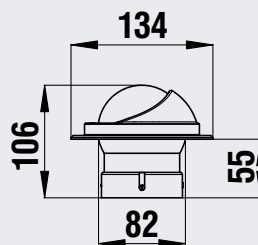
● **MED Certification**  
According to the directive MED 2014/90/EU, regarding lifeboats and rescue boats

**BA1**Su richiesta  
On request**BA1 installazione ad incasso orizzontale / Horizontal flush mounted****CARATTERISTICHE / KEY FEATURES**

Sospensione:	Semi-cardanica interna
<i>Gimbal type:</i>	<i>Internally half gimbaled</i>
Illuminazione:	12V di serie - 24V a richiesta
<i>Lighting:</i>	<i>12V standard 24V on request</i>
Letture:	Posteriore
<i>Reading:</i>	<i>Rear</i>
Divisione rosa:	5°
<i>Card graduations:</i>	<i>5°</i>
Diametro apparente:	2" 3/4 - 70 mm
<i>Apparent card dia:</i>	<i>2" 3/4 - 70 mm</i>

**CODICI ORDINAZIONE / ORDER CODES**

- 62.00114.01** Nera Rosa nera / *Black Black card*  
**62.00301.01** Grigia Rosa blu / *Grey Blue card*  
**62.00301.02** Bianca Rosa nera / *White Black card*

Rosa 5° / *Card graduations 5°*Rosa 5° / *Card graduations 5°*

Non necessita di omologazione per navigazione entro le 6 miglia.  
 Certificato MED su richiesta.  
 Quadrante disponibile nero o blu.  
 Schermo antiriflesso.  
 Completamente smontabili e riparabili.  
 Compensazione incorporata.

*No approvals needed for navigation within 6 miles.  
 MED certification on request.  
 Black or blue card available.  
 Anti-glare screen. Repairable.  
 Built-in compensation.*

SPONSOR - Barcolana 2016

**ARTICA SERIES 2" 3/4**



**BA3**  
Su richiesta  
On request 



**BA2**  
Su richiesta  
On request 

### BA3 installazione a chiesuola / Binnacle mounted

#### CARATTERISTICHE / KEY FEATURES

Sospensione:	Semi-cardanica interna
<i>Gimbal type:</i>	<i>Internally half gimbaled</i>
Illuminazione:	12V di serie (24V a richiesta)
<i>Lighting:</i>	<i>12V standard (24V on request)</i>
Lettura:	Posteriore
<i>Reading:</i>	<i>Rear</i>
Divisione rosa:	5°
<i>Card graduations:</i>	<i>5°</i>
Diametro apparente:	2" 3/4 - 70 mm
<i>Apparent card dia:</i>	<i>2" 3/4 - 70 mm</i>

#### CODICI ORDINAZIONE / ORDER CODES

- 62.00116.01** Nera Rosa nera / *Black Black card*  
**62.00305.01** Grigia Rosa blu / *Grey Blue card*  
**62.00305.02** Bianca Rosa nera / *White Black card*



Rosa 5° / Card graduations 5°



Rosa 5° / Card graduations 5°

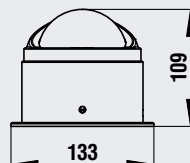
### BA2 installazione a staffa / Bracket mounted

#### CARATTERISTICHE / KEY FEATURES

Sospensione:	Semi-cardanica interna
<i>Gimbal type:</i>	<i>Internally half gimbaled</i>
Illuminazione:	12V di serie (24V a richiesta)
<i>Lighting:</i>	<i>12V standard (24V on request)</i>
Lettura:	Posteriore
<i>Reading:</i>	<i>Rear</i>
Divisione rosa:	5°
<i>Card graduations:</i>	<i>5°</i>
Diametro apparente:	2" 3/4 - 70 mm
<i>Apparent card dia:</i>	<i>2" 3/4 - 70 mm</i>

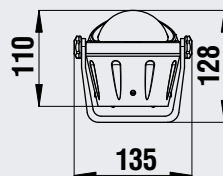
#### CODICI ORDINAZIONE / ORDER CODES

- 62.00115.01** Nera Rosa nera / *Black Black card*  
**62.00304.01** Grigia Rosa blu / *Grey Blue card*  
**62.00304.02** Bianca Rosa nera / *White Black card*



Non necessita di omologazione per navigazione entro le 6 miglia.  
 Certificato MED su richiesta.  
 Quadrante disponibile nero o blu.  
 Schermo antiriflesso.  
 Completamente smontabili e riparabili.  
 Compensazione incorporata.

*No approvals needed for navigation within 6 miles.  
 MED certification on request.  
 Black or blue card available.  
 Anti-glare screen. Repairable.  
 Built-in compensation.*



Non necessita di omologazione per navigazione entro le 6 miglia.  
 Certificato MED su richiesta.  
 Quadrante disponibile nero o blu.  
 Schermo antiriflesso.  
 Completamente smontabili e riparabili.  
 Compensazione incorporata.

*No approvals needed for navigation within 6 miles.  
 MED certification on request.  
 Black or blue card available.  
 Anti-glare screen. Repairable.  
 Built-in compensation.*



# Riviera

**BUSSOLE MAGNETICHE  
MAGNETIC COMPASSES**

---



**STELLA SERIES 2" 1/2**





## BUSSOLE MAGNETICHE / MAGNETIC COMPASSES

SERIE STELLA 2" 1/2 / STELLA SERIES 2" 1/2

### CARATTERISTICHE GENERALI / STANDARD FEATURES

- **Diametro apparente: 2" 1/2 (65 mm)**  
*Apparent diameter: 2" 1/2 (65 mm)*
- **Sospensione a spillo**  
*Jewel and pivot movements*
- **Lettura frontale**  
*Front reading*
- **Rosa nera/blu con gradazione di 5°**  
*Black/blue card, 5° graduation*
- **Schermo antiriflesso**  
*Anti-glare screen*



**NON NECESSITA DI OMOLOGAZIONE  
PER NAVIGAZIONE ENTRO LE 6 MIGLIA**  
**NO APPROVALS NEEDED  
FOR NAVIGATION WITHIN 6 MILES**

### BS1



Bussola magnetica installazione a baionetta  
*Bayonet joint mounted magnetic compass*

### BS2



Bussola magnetica installazione con supporto a staffa  
*Bracket mounted magnetic compass*

70 STELLA SERIES 2" 1/2



**BS1****BS2**

### BS1 installazione a baionetta / Bayonet joint mounted

#### CARATTERISTICHE / KEY FEATURES

Sospensione:	A spillo
<i>Gimbal type:</i>	<i>Jewel and pivot movements</i>
Letture:	Frontale
<i>Reading:</i>	<i>Direct</i>
Divisione rosa:	5°
<i>Card graduations:</i>	<i>5°</i>
Diametro apparente:	2" 1/2 - 65 mm
<i>Apparent card dia:</i>	<i>2" 1/2 - 65 mm</i>

#### CODICI ORDINAZIONE / ORDER CODES

- 62.00058.02** Nera Rosa nera / *Black Black card*  
**62.00059.02** Bianca Rosa nera / *White Black card*  
**62.00354.02** Grigia Rosa Blu / *Grey Blue card*



Rosa 5° / *Card graduations 5°*



Rosa 5° / *Card graduations 5°*

### BS2 installazione a staffa / Bracket mounted

#### CARATTERISTICHE / KEY FEATURES

Sospensione:	A spillo
<i>Gimbal type:</i>	<i>Jewel and pivot movements</i>
Letture:	Frontale
<i>Reading:</i>	<i>Direct</i>
Divisione rosa:	5°
<i>Card graduations:</i>	<i>5°</i>
Diametro apparente:	2" 1/2 - 65 mm
<i>Apparent card dia:</i>	<i>2" 1/2 - 65 mm</i>

#### CODICI ORDINAZIONE / ORDER CODES

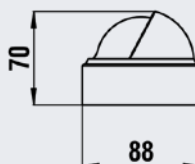
- 62.00068.02** Nera Rosa nera / *Black Black card*  
**62.00367.02** Bianca Rosa nera / *White Black card*  
**62.00355.02** Grigia Rosa Blu / *Grey Blue card*

### Accessori / Accessories



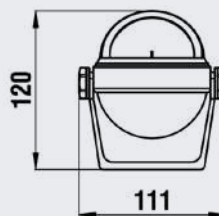
Staffetta  
*Bracket*

**COD. ORDINAZIONE / ORDER COD.**  
**61.01054.00**



Quadrante disponibile nero o blu.  
 Schermo antiriflesso.  
 Staffetta inclusa.

*Black Or Blue Card Available.*  
*Anti-Glare Screen.*  
*Bracket included*



Quadrante disponibile nero o blu.  
 Schermo antiriflesso.

*Black Or Blue Card Available.*  
*Anti-Glare Screen.*



# Riviera

**BUSSOLE MAGNETICHE**  
**MAGNETIC COMPASSES**

---



**ARIES SERIES 2" 1/2**

## BUSSOLE MAGNETICHE / MAGNETIC COMPASSES



SERIE ARIES 2" 1/2 / ARIES SERIES 2" 1/2

### CARATTERISTICHE GENERALI / STANDARD FEATURES

- **Diametro apparente: 2" 1/2 (65 mm)**  
*Apparent diameter: 2" 1/2 (65 mm)*
- **Sospensione a spillo**  
*Jewel and pivot movements*
- **Lettura frontale**  
*Front reading*
- **Rosa nera con gradazione di 5°**  
*Black card, 5° graduation*
- **Installazione a baionetta**  
*Bayonet joint mount*



**NON NECESSITA DI OMOLOGAZIONE  
PER NAVIGAZIONE ENTRO LE 6 MIGLIA**

**NO APPROVALS NEEDED  
FOR NAVIGATION WITHIN 6 MILES**



Rosa 5° / Card graduations 5°



### BAR installazione a baionetta / Bayonet joint mounted

#### CARATTERISTICHE / KEY FEATURES

Sospensione:	A spillo
<i>Gimbal type:</i>	<i>Jewel and pivot movements</i>
Lettura:	Frontale
<i>Reading:</i>	<i>Direct</i>
Divisione rosa:	5°
<i>Card graduations:</i>	<i>5°</i>
Diametro apparente:	2" 1/2 - 65 mm
<i>Apparent card dia:</i>	<i>2" 1/2 - 65 mm</i>

#### CODICI ORDINAZIONE / ORDER CODES

- 62.00405.04** Base **Nera** Rosa nera / *Black base Black card*
- 62.00405.05** Base **Gialla** Rosa nera / *Yellow base Black card*
- 62.00405.06** Base **Rossa** Rosa nera / *Red base Black card*
- 62.00405.07** Base **Blu** Rosa nera / *Blue base Black card*
- 62.00405.08** **Bianca** Rosa nera / *Total White Black card*
- 62.00405.09** **Nera** Rosa nera / *Total Black Black card*

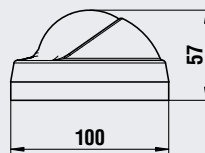
- NEW**
- 62.00405.14** Base **Nera** Rosa nera - Con luce / *Black base Black card - With light*
  - 62.00405.15** Base **Gialla** Rosa nera - Con luce / *Yellow base Black card - With light*
  - 62.00405.16** Base **Rossa** Rosa nera - Con luce / *Red base Black card - With light*
  - 62.00405.17** Base **Blu** Rosa nera - Con luce / *Blue base Black card - With light*
  - 62.00405.18** **Bianca** Rosa nera - Con luce / *Total White Black card - With light*
  - 62.00405.19** **Nera** Rosa nera - Con luce / *Total Black Black card - With light*

### Accessori / Accessories



Staffetta  
Bracket

**COD. ORDINAZIONE / ORDER COD.**  
**61.01054.00**



Quadrante nero. Schermo antiriflesso.  
Disponibile staffetta sgancio rapido.  
Staffetta inclusa

*Black Card. Anti-Glare Screen. Bracket Available.  
Bracket included*





# Riviera

**BUSSOLE MAGNETICHE**  
**MAGNETIC COMPASSES**

---



**COMET SERIES 2"**





**SERIE COMET 2" / COMET SERIES 2"**

**CARATTERISTICHE GENERALI / STANDARD FEATURES**

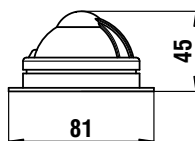
- **Diametro apparente: 2" (48 mm)**  
*Apparent diameter: 2" (48 mm)*
- **Calotta antiriflesso**  
*Anti-glare screen*
- **Sospensione a spillo**  
*Jewel and pivot movements*
- **Lettura frontale**  
*Front reading*
- **Rosa nera con gradazione di 5°**  
*Black card, 5° graduation*



**NON NECESSITA DI OMOLOGAZIONE  
PER NAVIGAZIONE ENTRO LE 6 MIGLIA**

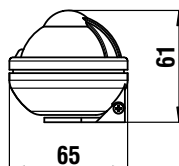
**NO APPROVALS NEEDED  
FOR NAVIGATION WITHIN 6 MILES**

**BC1**



Bussola magnetica installazione a chiesuola  
*Binnacle mounted magnetic compass*

**BC2**



Bussola magnetica installazione con supporto a staffa  
*Bracket mounted magnetic compass*



## BC1



## BC2



### BC1 installazione a chiesuola / Binnacle mounted

#### CARATTERISTICHE / KEY FEATURES

Sospensione:	A spillo
<i>Gimbal type:</i>	<i>Jewel and pivot movements</i>
Lettura:	Frontale
<i>Reading:</i>	<i>Direct</i>
Divisione rosa:	5°
<i>Card graduations:</i>	<i>5°</i>
Diametro apparente:	2" - 48 mm
<i>Apparent card dia:</i>	<i>2" - 48 mm</i>

#### CODICI ORDINAZIONE / ORDER CODES

- 62.00202.01** Nera Rosa nera / *Black Black card*  
**62.00316.01** Grigia Rosa Nera / *Grey Black card*



Rosa 5° / *Card graduations 5°*

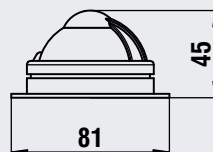
### BC2 installazione con supporto a staffa / Bracket mounted

#### CARATTERISTICHE / KEY FEATURES

Sospensione:	A spillo
<i>Gimbal type:</i>	<i>Jewel and pivot movements</i>
Lettura:	Frontale
<i>Reading:</i>	<i>Direct</i>
Divisione rosa:	5°
<i>Card graduations:</i>	<i>5°</i>
Diametro apparente:	2" - 48 mm
<i>Apparent card dia:</i>	<i>2" - 48 mm</i>

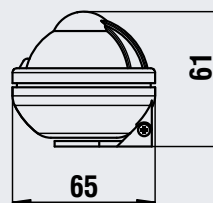
#### CODICI ORDINAZIONE / ORDER CODES

- 62.00203.01** Nera Rosa nera / *Black Black card*  
**62.00317.01** Grigia Rosa Nera / *Grey Black card*



Quadrante nero.  
Schermo antiriflesso.

*Black Card.*  
*Anti-Glare Screen.*



Quadrante nero.  
Schermo antiriflesso.

*Black Card.*  
*Anti-Glare Screen.*



**Riviera**

**BUSSOLE MAGNETICHE DA RILEVAMENTO  
MAGNETIC COMPASSES HANDBEARING**

---



**PRISMA SERIES 2" 1/4**



## BUSSOLE MAGNETICHE DA RILEVAMENTO / MAGNETIC COMPASSES HANDBEARING

SERIE PRISMA 2" 1/4 / PRISMA SERIE 2" 1/4

### CARATTERISTICHE GENERALI / STANDARD FEATURES

- **Diametro apparente 2" 1/4 (57,5 mm)**  
*Apparent diameter: 2" 1/4 (57,5 mm)*
- **Sospensione a spillo**  
*Jewel and pivot movements*
- **Lettura mediante prisma**  
*Prismatic lens reading*
- **Illuminazione di serie 1,5 V CC a batteria**  
*Standard 1,5V DC lighting (battery)*
- **Accessibili internamente in caso di riparazione**  
*Repairability*
- **Dispositivo a trappola d'aria**  
*Air bubble trap*
- **Rosa bianca con gradazione nera di 1°**  
*White card, 1° graduation*



BPS

### BPS da rilevamento / Handbearing

#### CARATTERISTICHE / KEY FEATURES

Sospensione:	A spillo
<i>Gimbal type:</i>	<i>Jewel and pivot movements</i>
Illuminazione:	1,5V CC a batteria di serie
<i>Lighting:</i>	<i>1,5V CC battery standard</i>
Lettura:	Mediante prisma
<i>Reading:</i>	<i>Prisma</i>
Divisione rosa:	1°
<i>Card graduations:</i>	<i>1°</i>
Diametro apparente:	2" 1/4 - 57,5 mm
<i>Apparent card dia:</i>	<i>2" 1/4 - 57,5 mm</i>

#### CODICI ORDINAZIONE / ORDER CODES

62.00093.01



Rosa 1° / Card graduations 1°

Quadrante bianco. Completamente smontabili e riparabili. Dispositivo a trappola d'aria. Disponibile custodia in stoffa imbottita o custodia in legno di faggio.

*White Card. Repairable. Air Bubble Trap. Wooden Box Available. Padded Carry-On Case Available. +*

### Accessori / Accessories



Custodia in legno di faggio  
*Wooden box*

**COD. ORDINAZIONE / ORDER COD.**  
**62.00106.01**



Custodia in stoffa imbottita  
*Carry-on case*

**COD. ORDINAZIONE / ORDER COD.**  
**62.00105.01**



# Riviera

**BUSSOLE MAGNETICHE DA RILEVAMENTO**  
**MAGNETIC COMPASSES HANDBEARING**

---



**ORION/MIZAR SERIES 1" 7/8**





## BUSSOLE MAGNETICHE DA RILEVAMENTO / MAGNETIC COMPASSES HANDBEARING

SERIE ORION/MIZAR 1" 7/8 / ORION/MIZAR SERIES 1" 7/8

### CARATTERISTICHE GENERALI / STANDARD FEATURES

- **Diametro apparente 1" 7/8**  
*Apparent diameter 1" 7/8*
- **Lettura frontale**  
*Direct reading*
- **Gradazione di 10°**  
*10° graduation*
- **Sospensione a spillo**  
*Jewel and pivot movements*
- **Galleggiante**  
*Floating*
- **Resistente agli urti**  
*Shock resistant*



#### BO da rilevamento serie Orion / Handbearing Orion series

##### CARATTERISTICHE / KEY FEATURES

Sospensione / <i>Gimbal type:</i>	A spillo / <i>Jewel and pivot movements</i>
Lettura / <i>Reading:</i>	Frontale / <i>Direct</i>
Divisione rosa / <i>Card graduations:</i>	10° / 10°
Dia. apparente / <i>Apparent card dia:</i>	1" 7/8 / 1" 7/8

##### CODICI ORDINAZIONE / ORDER CODES

- 62.00484.00** Grigia Rosa luminescente / *Grey Luminescent card*
- 62.00484.01** Gialla Rosa luminescente / *Yellow Luminescent card*
- 62.00484.02** Rossa Rosa luminescente / *Red Luminescent card*
- 62.00484.03** Blu Rosa luminescente / *Blue Luminescent card*
- 62.00484.04** Nera Rosa luminescente / *Black Luminescent card*

Rosa 10°  
Card graduations 10°



#### BM da rilevamento serie Mizar / Handbearing Mizar series

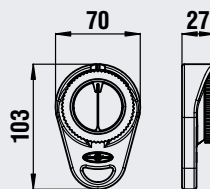
##### CARATTERISTICHE / KEY FEATURES

Sospensione / <i>Gimbal type:</i>	A spillo / <i>Jewel and pivot movements</i>
Lettura / <i>Reading:</i>	Frontale / <i>Direct</i>
Divisione rosa / <i>Card graduations:</i>	10° / 10°
Dia. apparente / <i>Apparent card dia:</i>	1" 7/8 / 1" 7/8

##### CODICI ORDINAZIONE / ORDER CODES

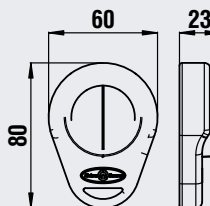
- 62.00420.00** Grigia Rosa Black / *Grigia Black card*
- 62.00420.01** Gialla Rosa Black / *Yellow Black card*
- 62.00420.02** Rossa Rosa Black / *Red Black card*
- 62.00420.03** Blu Rosa Black / *Blue Black card*
- 62.00420.04** Nera Rosa Black / *Black Black card*

Rosa 10°  
Card graduations 10°



Quadrante luminescente.  
Ghiera rotante. Galleggiante.  
Resistente agli urti.

*Luminescent Card, Rotating Ring,  
Floating, Shock Resistant.*



Quadrante nero. Galleggiante.  
Resistente agli urti.

*Black Card, Floating,  
Shock Resistant.*



# Riviera

**BUSSOLE SUBACQUEE  
DIVING COMPASSES**

---



**DIVING COMPASSES**



## BUSSOLE SUBACQUEE / DIVING COMPASSES

### SERIE DIVING "STANDARD" / "STANDARD" DIVING SERIES

#### CARATTERISTICHE GENERALI / STANDARD FEATURES

- **Liquido all'interno**  
*Oil filled*
- **Lettura dall'alto o laterale attraverso un'apposita finestra di lettura**  
*Read from above or from the side through a special reading window*
- **2 magneti per una risposta molto veloce**  
*Very fast response - 2 magnets*
- **Rosa luminescente con gradazione 10°**  
*Luminescent card with 10° gradation*
- **Ghiera girevole a scatti graduata**  
*Swivel trigger graduated ring*
- **Diametro: 60 mm. / 2.3"**  
*Diameter: 60 mm / 2.3"*
- **Altezza: 25 mm.**  
*Height: 25 mm.*
- **Peso: 40 gr.**  
*Weight: 40 gr.*
- **Opzioni: Emisfero Nord; Emisfero Sud**  
*Options: Northern hemisphere; Southern hemisphere*



Bussola standard – Solo Capsula  
*Standard Compass - Capsule only*



Bussola standard – versione da polso  
*Standard Compass - wrist model*



Bussola standard - Versione con corda elastica  
*Standard compass - bungee cord model*



Bussola standard + fondina  
*Standard compass + holster*

## STANDARD Solo capsula / Capsule only



Lettura laterale  
*Side reading*



CODICI ORDINAZIONE / ORDER CODES

62.00900.00

## STANDARD Versione da polso / Wrist model



Lettura laterale  
*Side reading*



CODICI ORDINAZIONE / ORDER CODES

62.00900.01

## STANDARD Versione con corda elastica / Bungee cord model



Lettura laterale  
*Side reading*



CODICI ORDINAZIONE / ORDER CODES

62.00900.02

## STANDARD + fondina / + holster



CODICI ORDINAZIONE / ORDER CODES

62.00900.03

Solo capsula

Opzioni: Emisfero Nord;  
Emisfero Sud;

Capsule only

Options: Northern hemisphere;  
Southern hemisphere;

Un ampio cinturino, conformato anatomicamente nella sua parte inferiore, permette di fissare stabilmente la bussola "Standard" al polso.

Peso: 90 gr.

Opzioni: Emisfero Nord;  
Emisfero Sud;

A wide band, which fits anatomically into its lower part, means the "Standard" compass can be attached stably to the wrist.

Weight: 90 gr.

Options: Northern hemisphere;  
Southern hemisphere;

Bussola "Standard" montata su supporto con corda elastica.

Peso: 65 gr.

Opzioni: Emisfero Nord;  
Emisfero Sud;

"Standard" Compass bungee cord mounted is far easier to do than buckled straps and is depth-compensating.

Weight: 65 gr.

Options: Northern hemisphere;  
Southern hemisphere;

Bussola "Standard" versione per installazione sul tubo.

Opzioni: Emisfero Nord;  
Emisfero Sud;

"Standard Compass" for mounting up to the hose.

Options: Northern hemisphere;  
Southern hemisphere;





## BUSSOLE SUBACQUEE / DIVING COMPASSES

### SERIE DIVING "PRO" / "PRO" DIVING SERIES

#### CARATTERISTICHE GENERALI / STANDARD FEATURES

- **Angolo di inclinazione della rosa fino a 30° garantendo sempre una rapida risposta**  
*Tilt allows the compass to be held at an angle of up to 30° and still respond quickly and accurately*
- **2 magneti per una rapida risposta**  
*Very fast response - 2 magnets*
- **Lettura laterale e superiore**  
*Top or side reading*
- **Numeri ben leggibili e chiari**  
*Bold numbers for easy reading*
- **Rosa luminescente**  
*Luminescent floating card*
- **Diametro: 56 mm. / 2.2"**  
*Diameter: 56 mm / 2.2"*
- **Altezza: 33 mm.**  
*Height: 33 mm.*
- **Peso: 55 gr.**  
*Weight: 55 gr.*
- **Opzioni: Emisfero Nord; Emisfero Sud**  
*Options: Northern hemisphere; Southern hemisphere*



Bussola Pro – Solo Capsula  
*Pro Compass - Capsule only*



Bussola Pro – versione da polso  
*Pro Compass - wrist model*



Bussola Pro - Versione con corda elastica nera  
*Pro compass - bungee cord model black*



Bussola Pro - Versione con corda elastica grigia  
*Pro compass - bungee cord model grey*



## PRO Solo capsula / Capsule only



Lettura laterale  
*Side reading*



### CODICI ORDINAZIONE / ORDER CODES

62.00901.00

## PRO Versione da polso / wrist model



Lettura laterale  
*Side reading*



### CODICI ORDINAZIONE / ORDER CODES

62.00901.01

## PRO Versione con corda elastica / Bungee cord model



Lettura laterale / *Side reading*



### CODICI ORDINAZIONE / ORDER CODES

62.00901.02 Nera / Black

62.00901.03 Grigia / Grey

Solo capsula

Opzioni: Emisfero Nord;  
Emisfero Sud;

Capsule only

Opzioni: Northern hemisphere;  
Southern hemisphere;

Un ampio cinturino, conformato anatomicamente nella sua parte inferiore, permette di fissare stabilmente la bussola "Pro" al polso.

Peso: 110 gr.

Opzioni: Emisfero Nord;  
Emisfero Sud;

A wide band, which fits anatomically into its lower part, means the "Pro" compass can be attached stably to the wrist.

Weight: 110 gr.

Opzioni: Northern hemisphere;  
Southern hemisphere;

Bussola "Pro" montata su supporto con corda elastica.

Peso: 80 gr.

Opzioni: Emisfero Nord;  
Emisfero Sud;

"Pro" Compass bungee cord mounted is far easier to do than buckled straps and is depth-compensating.

Weight: 80 gr.

Opzioni: Northern hemisphere;  
Southern hemisphere;





## BUSSOLE SUBACQUEE / DIVING COMPASSES

### SERIE DIVING "2K" / "2K" DIVING SERIES

#### CARATTERISTICHE GENERALI / STANDARD FEATURES

- **Liquido all'interno**  
*Oil filled*
- **Lettura dall'alto o laterale attraverso un'apposita finestra di lettura**  
*Read from above or from the side through a special reading window*
- **2 magneti per una risposta molto veloce**  
*Very fast response - 2 magnets*
- **Rosa luminescente con gradazione 10°**  
*Luminescent card with 10° gradation*
- **Ghiera girevole a scatti graduata**  
*Swivel trigger graduated ring*
- **Diametro: 48 mm. / 1.8"**  
*Diameter: 48 mm. / 1.8"*
- **Altezza: 13 mm.**  
*Height: 13 mm.*
- **Peso: 33 gr.**  
*Weight: 33 gr.*
- **Opzioni: Emisfero Nord; Emisfero Sud**  
*Options: Northern hemisphere; Southern hemisphere*



Bussola 2K – Solo Capsula  
*Standard Compass - Capsule only*



Bussola 2K – versione da polso  
*Standard Compass - wrist model*

#### 2K Solo capsula / Capsule only



CODICI ORDINAZIONE / ORDER CODES  
**62.00902.00**



Lettura laterale  
*Side reading*

Solo capsula  
**Opzioni:** Emisfero Nord;  
Emisfero Sud;

Capsule only  
**Options:** Northern hemisphere;  
Southern hemisphere;

#### 2K Versione da polso / wrist model



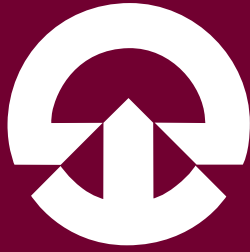
CODICI ORDINAZIONE / ORDER CODES  
**62.00902.01**

Lettura laterale  
*Side reading*



Un ampio cinturino, conformato anatomicamente nella sua parte inferiore, permette di fissare stabilmente la bussola "2k" al polso  
**Peso:** 85 gr.  
**Opzioni:** Emisfero Nord;  
Emisfero Sud;

A wide band, which fits anatomically into its lower part, means the "2k" compass can be attached stably to the wrist  
**Weight:** 85 gr  
**Options:** Northern hemisphere;  
Southern hemisphere



# Riviera

**SISTEMI AUDIO  
AUDIO SYSTEM**

---



**WATERPROOF SPEAKERS**



DIAM 165

FLAT SERIES COUPLE SPEAKERS

NON-MAGNETIC SERIES COUPLE SPEAKERS

AP01  
AP03

Bianca / White



Carbonio / Carbon



Radica / Briar-root



Metallo / Metal

## AP01 coppia diffusori acustici impermeabili / couple waterproof speakers

## CARATTERISTICHE / KEY FEATURES

Diametro / Diameter: 165 / 165

Magnete / Magneto: Neodimio / Neodymium

## CODICI ORDINAZIONE / ORDER CODES

	Tipo	W	DB	RIS. Hz	Kg	Mascherina	ohm	A	B	C	D
	Type	W	Db	RIS Hz	Kg	Grill	ohm	A	B	C	D
<b>62.00428.01</b>	Due vie	120	90	60-20000	0,547	Bianca anti UV	4	172-81-62-142			
	2 Ways	120	90	60-20000	0,547	White anti UV	4	172-81-62-142			
<b>62.00428.10</b>	Due vie	120	90	60-20000	0,547	Carbonio anti UV	4	172-81-62-142			
	2 Ways	120	90	60-20000	0,547	Carbon anti UV	4	172-81-62-142			
<b>62.00428.20</b>	Due vie	120	90	60-20000	0,547	Radica anti UV	4	172-81-62-142			
	2 Ways	120	90	60-20000	0,547	Briar-root anti UV	4	172-81-62-142			
<b>62.00628.00</b>	Doppio cono	80	89	60-16000	0,700	Bianca anti UV	4	172-50-30-142			
	Dual-cone	80	89	60-16000	0,700	White anti UV	4	172-50-30-142			
<b>62.00628.10</b>	Doppio cono	80	89	60-16000	0,700	Carbonio anti UV	4	172-50-30-142			
	Dual-cone	80	89	60-16000	0,700	Carbon anti UV	4	172-50-30-142			
<b>62.00628.20</b>	Doppio cono	80	89	60-16000	0,700	Radica anti UV	4	172-50-30-142			
	Dual-cone	80	89	60-16000	0,700	Briar-root anti UV	4	172-50-30-142			
<b>62.00629.00</b>	Doppio cono	80	89	60-16000	0,770	Metallo	4	183-49-32-142			
	Dual-cone	80	89	60-16000	0,770	Metal	4	183-49-32-142			

I modelli con mascherina in metallo sono per usi interni.

Speakers with metallic grill are for inside use only.

AP03 coppia diffusori acustici amagnetici impermeabili  
couple non-magnetic waterproof speakers

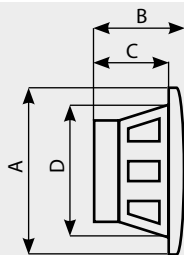
## CARATTERISTICHE / KEY FEATURES

Diametro / Diameter: 165 / 165

Magnete / Magneto: Standard - Ferrite / Standard - Ferrite

## CODICI ORDINAZIONE / ORDER CODES

	Tipo	W	DB	RIS. Hz	Kg	Mascherina	ohm	A	B	C	D
	Type	W	Db	RIS Hz	Kg	Grill	ohm	A	B	C	D
<b>62.00423.01</b>	Doppio cono	80	90	55-16000	0,893	Bianca anti UV	4	172-80-61-142			
	Dual-cone	80	90	55-16000	0,893	White anti UV	4	172-80-61-142			
<b>62.00423.10</b>	Doppio cono	80	90	55-16000	0,893	Carbonio anti UV	4	172-80-61-142			
	Dual-cone	80	90	55-16000	0,893	Carbon anti UV	4	172-80-61-142			
<b>62.00423.20</b>	Doppio cono	80	90	55-20000	0,893	Radica anti UV	4	172-80-61-142			
	Dual-cone	80	90	55-16000	0,893	Briar-root anti UV	4	172-80-61-142			
<b>62.00424.01</b>	Due vie	120	90	50-20000	0,895	Bianca anti UV	4	172-80-61-142			
	2 Ways	120	90	50-20000	0,895	White anti UV	4	172-80-61-142			
<b>62.00424.10</b>	Due vie	120	90	50-20000	0,895	Carbonio anti UV	4	172-80-61-142			
	2 Ways	120	90	50-20000	0,895	Carbon anti UV	4	172-80-61-142			
<b>62.00424.20</b>	Due vie	120	90	50-20000	0,895	Radica anti UV	4	172-80-61-142			
	2 Ways	120	90	50-20000	0,895	Briar-root anti UV	4	172-80-61-142			



Direttiva 2014/35/UE  
Sospensione in gomma trattata.  
Supporti delle bobine in kapton.  
Cestello in metallo cromato.  
Cestello in ixef.  
Terminali placcati oro.  
Viti montaggio in acciaio inox.  
Mascherina in plastica personalizzabile optional.  
Qualità sonora eccellente.

Directive 2014/35/UE requirements  
Treated Rubber Suspension  
Kapton Coil Supports. Ixef Cone.  
Gold Plated Terminals.  
Stainless Steel Screws. Plastic grill can be personalized on request.  
Excellent audio quality.

Direttiva 2014/35/UE  
Sospensione in gomma trattata.  
Supporti delle bobine in kapton.  
Cestello in metallo cromato.  
Cestello in ixef.  
Terminali placcati oro.  
Viti montaggio in acciaio inox.  
Mascherina in plastica personalizzabile optional.  
Qualità sonora eccellente.

Directive 2014/35/UE requirements  
Treated Rubber Suspension  
Kapton Coil Supports. Ixef Cone.  
Gold Plated Terminals.  
Stainless Steel Screws. Plastic grill can be personalized on request.  
Excellent audio quality.

## APS01



Bianca / White



Carbonio / Carbon



Radica / Briar-root



Metallo / Metal

### APS01 coppia diffusori acustici impermeabili / couple waterproof speakers

#### CARATTERISTICHE / KEY FEATURES

Diametro / Diameter: 165 / 165

Magnete / Magneto: Standard - Ferrite / Standard - Ferrite

#### CODICI ORDINAZIONE / ORDER CODES

	Tipo Type	W W	DB Db	RIS. Hz RIS Hz	Kg Kg	Mascherina Grill	ohm ohm	A	B	C	D	
								A	B	C	D	
<b>62.00741.00</b>	Due vie	200	93	50-20000	1,40	Bianca anti UV	4	172-85-68-142				
	2 Ways	200	93	50-20000	1,40	White anti UV	4	172-85-68-142				
<b>62.00741.10</b>	Due vie	200	93	50-20000	1,40	Carbonio anti UV	4	172-85-68-142				
	2 Ways	200	93	50-20000	1,40	Carbon anti UV	4	172-85-68-142				
<b>62.00741.20</b>	Due vie	200	93	50-20000	1,40	Radica anti UV	4	172-85-68-142				
	2 Ways	200	93	50-20000	1,40	Briar-root anti UV	4	172-85-68-142				
<b>62.00742.00</b>	Due vie	200	93	50-20000	1,40	Metallo	4	183-85-68-142				
	2 Ways	200	93	50-20000	1,40	Metal	4	182-85-68-142				

I modelli con mascherina in metallo sono per usi interni.

Speakers with metallic grill are for inside use only.

#### MASCHERINE DI RICAMBIO (Ø165) / GRILL ACCESSORIES (Ø165)

#### CODICI ORDINAZIONE / ORDER CODES



60.01063.00

Bianca / White



60.01063.10

Carbonio / Carbon



60.01063.20

Radica / Briar-root



60.01104.00

Metallo / Metal

## SUBWOOFER

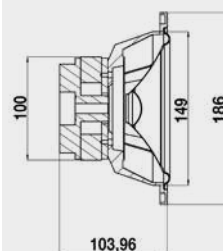
#### CARATTERISTICHE / KEY FEATURES

Diametro / Diameter: 165 / 165

Magnete / Magneto: Standard - Ferrite / Standard - Ferrite

#### CODICI ORDINAZIONE / ORDER CODES

	Tipo Type	W W	DB Db	RIS. Hz RIS Hz	Kg Kg	ohm ohm
	Sub.	140	92	50-20000	2,00	4



Direttiva 2014/35/UE  
Sospensione in gomma trattata.  
Supporti delle bobine in kapton.  
Cestello di ixef.  
Terminali placcati oro.  
Viti montaggio in acciaio inox.

Directive 2014/35/UE requirements  
Treated Rubber Suspension  
Kapton Coil Supports. Ixef Cone.  
Gold Plated Terminals. Stainless  
Steel Screws.



DIAM 165

HI-FI SERIES COUPLE SPEAKERS

subwoofer  
WAVE EXTREME SERIES



AP04  
AP06

Bianca / White



Carbonio / Carbon



Radica / Briar-root

## AP04 coppia diffusori acustici impermeabili / couple waterproof speakers

## CARATTERISTICHE / KEY FEATURES

Diametro / Diameter:	130 / 130
Magnete / Magneto:	Neodimio / Neodymium

## CODICI ORDINAZIONE / ORDER CODES

	Tipo	W	DB	RIS. Hz	Kg	Mascherina	ohm	A	B	C	D
	Type	W	Db	RIS Hz	Kg	Grill	ohm	A	B	C	D
<b>62.00429.01</b>	Doppio cono	80	90	55-16000	0,505	Bianca anti UV	4	140-69-50-110			
	Dual-cone	80	90	55-16000	0,505	White anti UV	4	140-69-50-110			
<b>62.00429.10</b>	Doppio cono	80	90	55-16000	0,505	Carbonio anti UV	4	140-69-50-110			
	Dual-cone	80	90	55-16000	0,505	Carbon anti UV	4	140-69-50-110			
<b>62.00429.20</b>	Doppio cono	80	90	55-16000	0,505	Radica anti UV	4	140-69-50-110			
	Dual-cone	80	90	55-16000	0,505	Briar-root anti UV	4	140-69-50-110			

## MASCHERINE DI RICAMBIO (Ø130) / GRILL ACCESSORIES (Ø130)

## CODICI ORDINAZIONE / ORDER CODES

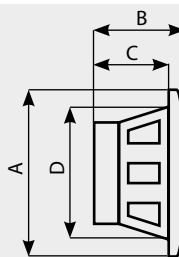
**60.01064.00**  
Bianca / White**60.01064.10**  
Carbonio / Carbon**60.01064.20**  
Radica / Briar-rootAP06 coppia diffusori acustici amagnetici impermeabili  
couple non-magnetic waterproof speakers

## CARATTERISTICHE / KEY FEATURES

Diametro / Diameter:	130 / 130
Magnete / Magneto:	Standard - Ferrite / Standard - Ferrite

## CODICI ORDINAZIONE / ORDER CODES

	Tipo	W	DB	RIS. Hz	Kg	Mascherina	ohm	A	B	C	D
	Type	W	Db	RIS Hz	Kg	Grill	ohm	A	B	C	D
<b>62.00425.01</b>	Doppio cono	80	90	55-16000	0,864	Bianca anti UV	4	140-82-62-110			
	Dual-cone	80	90	55-16000	0,864	White anti UV	4	140-82-62-110			
<b>62.00425.10</b>	Doppio cono	80	90	55-16000	0,864	Carbonio anti UV	4	140-82-62-110			
	Dual-cone	80	90	55-16000	0,864	Carbon anti UV	4	140-82-62-110			
<b>62.00425.20</b>	Doppio cono	80	90	55-20000	0,864	Radica anti UV	4	140-82-62-110			
	Dual-cone	80	90	55-16000	0,864	Briar-root anti UV	4	140-82-62-110			
<b>62.00426.01</b>	Due vie	120	90	50-20000	0,867	Bianca anti UV	4	140-82-62-110			
	2 Ways	120	90	50-20000	0,867	White anti UV	4	140-82-62-110			
<b>62.00426.10</b>	Due vie	120	90	50-20000	0,867	Carbonio anti UV	4	140-82-62-110			
	2 Ways	120	90	50-20000	0,867	Carbon anti UV	4	140-82-62-110			
<b>62.00426.20</b>	Due vie	120	90	50-20000	0,867	Radica anti UV	4	140-82-62-110			
	2 Ways	120	90	50-20000	0,867	Briar-root anti UV	4	140-82-62-110			



Direttiva 2014/35/UE  
Sospensione in gomma trattata.  
Supporti delle bobine in kapton.  
Cestello di ixef.  
Terminali placcati oro.  
Viti montaggio in acciaio inox.  
Qualità sonora eccellente.  
Mascherina in plastica personalizzabile optional.

Directive 2014/35/UE requirements  
Treated Rubber Suspension.  
Kapton Coil Supports. Ixef Cone.  
Gold Plated Terminals. Stainless Steel Screws.

Direttiva 2014/35/UE  
Sospensione in gomma trattata.  
Supporti delle bobine in kapton.  
Cestello di ixef.  
Terminali placcati oro.  
Viti montaggio in acciaio inox.  
Qualità sonora eccellente.  
Mascherina in plastica personalizzabile optional.

Directive 2014/35/UE requirements  
Treated Rubber Suspension.  
Kapton Coil Supports. Ixef Cone.  
Gold Plated Terminals. Stainless Steel Screws.

## AP07



DIAM 100

### AP07 coppia diffusori acustici impermeabili / couple waterproof speakers

#### CARATTERISTICHE / KEY FEATURES

Diametro / *Diameter:* 100 / 100

Magnete / *Magneto:* Standard - Ferrite / *Standard - Ferrite*

#### CODICI ORDINAZIONE / ORDER CODES

	Tipo	W	DB	RIS. Hz	Kg	Mascherina	ohm	A	B	C	D
	<i>Type</i>	<i>W</i>	<i>Db</i>	<i>RIS Hz</i>	<i>Kg</i>	<i>Grill</i>	<i>ohm</i>	<i>A</i>	<i>B</i>	<i>C</i>	<i>D</i>
<b>62.00494.01</b>	Doppio cono	60	89	70-16000	0,60	Metallo nera	4	145-66-47-100			
	<i>Dual-cone</i>	<i>60</i>	<i>89</i>	<i>70-16000</i>	<i>0,60</i>	<i>Blackmetal</i>	<i>4</i>	<i>145-66-47-100</i>			
<b>62.00494.02</b>	Doppio cono	60	89	70-16000	1,60	Metallo bianca	4	145-66-47-100			
	<i>Dual-cone</i>	<i>60</i>	<i>89</i>	<i>70-16000</i>	<i>0,60</i>	<i>White metal</i>	<i>4</i>	<i>145-66-47-100</i>			

I modelli con mascherina in metallo sono per usi interni.

*Speakers with metallic grill are for inside use only.*

#### MASCHERINE DI RICAMBIO (Ø100) / GRILL ACCESSORIES (Ø100)

#### CODICI ORDINAZIONE / ORDER CODES



**60.01090.00**

Metallo bianco / *White metal*



**60.01091.00**

Metallo nera / *Black metal*

Direttiva 2014/35/UE

Sospensione in gomma trattata.

Supporti delle bobine in kapton.

Cestello in metallo cromato.

Terminali placcati oro.

Viti montaggio in acciaio inox.

*Directive 2014/35/UE requirements*

*Treated Rubber Suspension. Kapton*

*Coil Supports. Chromium Plated*

*Cone. Gold Plated Terminals.*

*Stainless Steel Screws.*



91 INSIDE USE



## AP08



Box ad incasso / Flush mount

## AP09



Installazione a staffa / Bracket mount

### AP08 singolo diffusore acustico amagnetico impermeabile per VHF box ad incasso single waterproof flush mounts peaker for VHF box

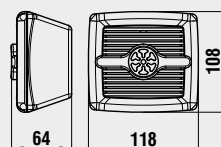
#### CARATTERISTICHE / KEY FEATURES

Diametro / Diameter: 87 / 87

Magnete / Magneto: Standard - Ferrite / Standard - Ferrite

#### CODICI ORDINAZIONE / ORDER CODES

	Tipo Type	W W	DB Db	RIS. Hz RIS Hz	Kg Kg	Mascherina Grill	ohm ohm
<b>62.00350.01</b>	Doppio cono	10	88	80-18000	0,661	White anti UV	4
	Dual-cone	10	88	80-18000	0,661	White anti UV	4
<b>62.00352.01</b>	Doppio cono	10	88	80-18000	0,661	White anti UV	8
	Dual-cone	10	88	80-18000	0,661	White anti UV	8
<b>62.00336.01</b>	Doppio cono	60	88	80-18000	0,665	White anti UV	4
	Dual-cone	60	88	80-18000	0,665	White anti UV	4
<b>62.00338.01</b>	Due vie	60	89	80-20000	0,665	White anti UV	4
	2 Ways	60	89	80-20000	0,665	White anti UV	4



Direttiva 2014/35/UE  
Sospensione in gomma trattata.  
Supporti delle bobine in kapton.  
Cestello in metallo verniciato a  
polvere.  
Terminali placcati oro.  
Viti montaggio in acciaio inox.

Directive 2014/35/UE requirements  
Treated Rubber Suspension.  
Kapton Coil Supports. Metal painted  
to powder Cone.  
Gold Plated Terminals. Stainless  
Steel Screws.

### AP09 singolo diffusore acustico amagnetico impermeabile per VHF installazione a staffa single waterproof bracket mount speaker for VHF

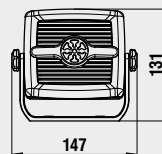
#### CARATTERISTICHE / KEY FEATURES

Diametro / Diameter: 87 / 87

Magnete / Magneto: Standard - Ferrite / Standard - Ferrite

#### CODICI ORDINAZIONE / ORDER CODES

	Tipo Type	W W	DB Db	RIS. Hz RIS Hz	Kg Kg	Mascherina Grill	ohm ohm
<b>62.00350.10</b>	Doppio cono	10	88	80-18000	0,661	White anti UV	4
	Dual-cone	10	88	80-18000	0,661	White anti UV	4
<b>62.00352.10</b>	Doppio cono	10	88	80-18000	0,661	White anti UV	8
	Dual-cone	10	88	80-18000	0,661	White anti UV	8
<b>62.00336.10</b>	Doppio cono	60	88	80-18000	0,665	White anti UV	4
	Dual-cone	60	88	80-18000	0,665	White anti UV	4
<b>62.00338.10</b>	Due vie	60	89	80-20000	0,665	White anti UV	4
	2 Ways	60	89	80-20000	0,665	White anti UV	4



Direttiva 2014/35/UE  
Sospensione in gomma trattata.  
Supporti delle bobine in kapton.  
Cestello in metallo verniciato a  
polvere.  
Terminali placcati oro.  
Viti montaggio in acciaio inox.

Directive 2014/35/UE requirements  
Treated Rubber Suspension.  
Kapton Coil Supports. Metal painted  
to powder Cone.  
Gold Plated Terminals. Stainless  
Steel Screws.

#### Accessori / Accessories

MASCHERINA in plastica bianca (Ø100)  
GRILL white polypropylene (Ø87)



COD. ORDINAZIONE / ORDER COD.  
60.01025.00



## AP010 AP012



### AP010 coppia diffusori acustici impermeabili / couple waterproof speakers

#### CARATTERISTICHE / KEY FEATURES

Diametro / *Diameter*: 165 / 165  
Magnete / *Magneto*: Neodimio / *Neodymium*

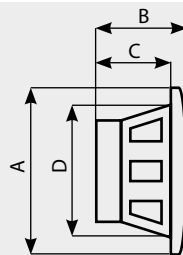
#### CODICI ORDINAZIONE / ORDER CODES

Tipo	W	DB	RIS. Hz	Kg	Mascherina	ohm	A	B	C	D
Type	W	Db	RIS Hz	Kg	Grill	ohm	A	B	C	D
62.00792.00 Doppio cono	80	89	55-16000	0,700	Bianca anti UV	4	195-50-30-142			
Dual-cone	80	89	55-16000	0,700	White anti UV	4	195-50-30-142			
62.00793.00 Due vie	120	90	60-20000	0,547	Bianca anti UV	4	195-81-62-142			
2 Ways	120	90	60-20000	0,547	White anti UV	4	195-81-62-142			



60.03275.00  
Bianca / White

Bianca / White



Direttiva 2014/35/UE  
Sospensione in gomma trattata.  
Supporti delle bobine in kapton.  
Cestello in metallo cromato.  
Cestello in ixef.  
Terminali placcati oro.  
Viti montaggio in acciaio inox.  
Mascherina in plastica personalizzabile optional.  
Qualità sonora eccellente.

Directive 2014/35/UE requirements  
Treated Rubber Suspension  
Kapton Coil Supports. Ixef Cone.  
Gold Plated Terminals.  
Stainless Steel Screws. Plastic grill can be personalized on request.  
Excellent audio quality.

### AP012 coppia diffusori acustici amagnetici impermeabili couple non-magnetic waterproof speakers

#### CARATTERISTICHE / KEY FEATURES

Diametro / *Diameter*: 165 / 165  
Magnete / *Magneto*: Standard - Ferrite / *Standard - Ferrite*

#### CODICI ORDINAZIONE / ORDER CODES

Tipo	W	DB	RIS. Hz	Kg	Mascherina	ohm	A	B	C	D
Type	W	Db	RIS Hz	Kg	Grill	ohm	A	B	C	D
62.00795.00 Doppio cono	80	90	55-16000	0,893	Bianca anti UV	4	195-80-61-142			
Dual-cone	80	90	55-16000	0,893	White anti UV	4	195-80-61-142			
62.00796.00 Due vie	120	90	50-20000	0,895	Bianca anti UV	4	195-80-61-142			
2 Ways	120	90	50-20000	0,895	White anti UV	4	195-80-61-142			

MASCHERINE DI RICAMBIO (Ø165) / GRILL ACCESSORIES (Ø165)

#### CODICI ORDINAZIONE / ORDER CODES

Direttiva 2014/35/UE  
Sospensione in gomma trattata.  
Supporti delle bobine in kapton.  
Cestello in metallo cromato.  
Cestello in ixef.  
Terminali placcati oro.  
Viti montaggio in acciaio inox.  
Mascherina in plastica personalizzabile optional.  
Qualità sonora eccellente.

Directive 2014/35/UE requirements  
Treated Rubber Suspension  
Kapton Coil Supports. Ixef Cone.  
Gold Plated Terminals.  
Stainless Steel Screws. Plastic grill can be personalized on request.  
Excellent audio quality.



DIAM 165

FLAT SERIES COUPLE SPEAKERS

NON-MAGNETIC SERIES COUPLE SPEAKERS



APS013



Bianca / White

**APS013 coppia diffusori acustici impermeabili / couple waterproof speakers****CARATTERISTICHE / KEY FEATURES**

Diametro / Diameter: 165 / 165

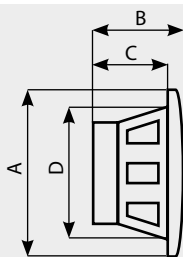
Magnete / Magneto: Standard - Ferrite / Standard - Ferrite

**CODICI ORDINAZIONE / ORDER CODES**

	Tipo	W	DB	RIS. Hz	Kg	Mascherina	ohm	A	B	C	D
	Type	W	Db	RIS Hz	Kg	Grill	ohm	A	B	C	D
<b>62.00797.00</b>	Due vie	200	93	50-20000	1,40	Bianca anti UV	4	195-85-68-142			
	2 Ways	200	93	50-20000	1,40	White anti UV	4	195-85-68-142			

**MASCHERINE DI RICAMBIO (Ø165) / GRILL ACCESSORIES (Ø165)****CODICI ORDINAZIONE / ORDER CODES****60.03275.00**

Bianca / White



Direttiva 2014/35/UE  
 Sospensione in gomma trattata.  
 Supporti delle bobine in kapton.  
 Cestello in ixef. Terminali placcati oro.  
 Viti montaggio in acciaio  
 inox. Mascherina personalizzabile  
 optional.  
 Qualità sonora eccellente.

Directive 2014/35/UE requirements  
 Treated Rubber Suspension  
 Kapton Coil Supports. Ixef Cone.  
 Gold Plated Terminals. Stainless  
 Steel Screws. Plastic grill can be  
 personalized on request. Excellent  
 audio quality.





## AP014 AP015



Bianca / White

### AP014 coppia diffusori acustici impermeabili / couple waterproof speakers

#### CARATTERISTICHE / KEY FEATURES

Diametro / Diameter: 130 / 130

Magnete / Magneto: Neodimio / Neodymium

#### CODICI ORDINAZIONE / ORDER CODES

	Tipo	W	DB	RIS. Hz	Kg	Mascherina	ohm	A	B	C	D
	Type	W	Db	RIS Hz	Kg	Grill	ohm	A	B	C	D
<b>62.00798.00</b>	Doppio cono	80	90	55-16000	0,505	Bianca anti UV	4	160-69-49-110			
	Dual-cone	80	90	55-16000	0,505	White anti UV	4	140-69-49-110			

#### MASCHERINE DI RICAMBIO (Ø130) / GRILL ACCESSORIES (Ø130)

#### CODICI ORDINAZIONE / ORDER CODES



**60.03276.00**

Bianca / White

### AP015 coppia diffusori acustici amagnetici impermeabili couple non-magnetic waterproof speakers

#### CARATTERISTICHE / KEY FEATURES

Diametro / Diameter: 130 / 130

Magnete / Magneto: Standard - Ferrite / Standard - Ferrite

#### CODICI ORDINAZIONE / ORDER CODES

	Tipo	W	DB	RIS. Hz	Kg	Mascherina	ohm	A	B	C	D
	Type	W	Db	RIS Hz	Kg	Grill	ohm	A	B	C	D
<b>62.00799.00</b>	Doppio cono	80	90	55-16000	0,864	Bianca anti UV	4	160-82-62-110			
	Dual-cone	80	90	55-16000	0,864	White anti UV	4	160-82-62-110			
<b>62.00842.00</b>	Due vie	120	90	50-20000	0,867	Bianca anti UV	4	160-82-62-110			
	2 Ways	120	90	50-20000	0,867	White anti UV	4	160-82-62-110			

Direttiva 2014/35/UE  
Sospensione in gomma trattata.  
Supporti delle bobine in kapton.  
Cestello di ixef.  
Terminali placcati oro.  
Viti montaggio in acciaio inox.  
Qualità sonora eccellente.  
Mascherina in plastica personalizzabile optional.

Directive 2014/35/UE requirements  
Treated Rubber Suspension.  
Kapton Coil Supports. Ixef Cone.  
Gold Plated Terminals. Stainless Steel Screws.

Direttiva 2014/35/UE  
Sospensione in gomma trattata.  
Supporti delle bobine in kapton.  
Cestello di ixef.  
Terminali placcati oro.  
Viti montaggio in acciaio inox.  
Qualità sonora eccellente.  
Mascherina in plastica personalizzabile optional.

Directive 2014/35/UE requirements  
Treated Rubber Suspension.  
Kapton Coil Supports. Ixef Cone.  
Gold Plated Terminals. Stainless Steel Screws.



DIAM 130

FLAT SERIES COUPLE SPEAKERS

95 NON-MAGNETIC SERIES COUPLE SPEAKERS



## KIT AMPLIFICATORE BLUETOOTH / BLUETOOTH AMPLIFIER KIT



### CODICI ORDINAZIONE / ORDER CODES

**62.00786.00**

**KIT:** 2 casse 120W amagnetiche (entrambi i design)  
+ **R904** amplificatore bluetooth

**KIT:** 2x 120W non-magnetic speakers (both designs)  
+ **R904** Bluetooth amplifier

**62.00787.00**

**KIT:** 2 casse 200W (entrambi i design)  
+ **R904** amplificatore bluetooth

**KIT:** 2x 200W speakers (both designs)  
+ **R904** Bluetooth amplifier

**62.00788.00**

**R904** Amplificatore Bluetooth

**R904** Bluetooth amplifier

IL **Boat Amplifier R904** sviluppato da **Riviera** costituisce l'ultima evoluzione nel campo del Sea Sound. Conoscevoli che ormai tutti possiedono almeno uno smartphone, un tablet e/o un pc è possibile diffondere la vostra musica nell'imbarcazione sfruttando il protocollo dati Bluetooth. Basta quindi con buchi sulla plancia di comando per incassare autoradio o touch panel, cablaggi e accessori: installare il **Boat Amplifier R904** richiederà un tempo minimo e vi permetterà di ascoltare i vostri brani preferiti con un suono profondo e pulito, grazie ai suoi 80 Watt RMS per canale e la possibilità di collegare fino a 8 altoparlanti (4 Ohm) tra canale sinistro e destro; oppure creare una connessione con 4 altoparlanti e installare un Subwoofer per bassi potenti e profondi. I controlli integrati sul pannello del **Boat Amplifier R904** permettono di regolare ed equalizzare la qualità del suono.

*The Boat Amplifier R904 developed by Riviera is the latest evolution in the field of Sea Sound. Aware that by now everyone has at least a smartphone, tablet and/or a PC, you can listen to your music on the boat using the Bluetooth protocol data. Stop with holes on the control panel building-in touch panel, car radio, wiring and accessories: install the Boat Amplifier R904 will require minimal time and will allow you to listen to your favorite songs with a deep and clean sound, thanks to its 80 Watt RMS for channel and the ability to connect up to 8 speakers (4 Ohm) between left and right channels; or you can create a connection with 4 speakers and install a Subwoofer for powerful and deep bass. The builtin controls on the panel of the Boat Amplifier R904 allow you to adjust and equalize the sound quality.*

### R904 CARATTERISTICHE GENERALI / STANDARD FEATURES

- 80Wx4 Impedenza 4 Ohm e tensione di alimentazione 14.4V .Watt RMS  
*4 ohm load RMS power at 14.4V*
- 120Wx4 Impedenza 2 Ohm e tensione di alimentazione 14.4V .Watt RMS  
*2 ohm load RMS power at 14.4V*
- 230Wx2 Impedenza 4 Ohm connessione a ponte e tensione di alimentazione  
*4 ohms load bridged RMS power at 14.4V*
- 0.2~5 Livello del segnale in ingresso  
*Input Level*
- 10~35KHz Risposta in Frequenza  
*Frequency response*
- <0.1% Distorsione armonica al 30% di potenza  
*THD at 4 ohm load 30% rated power*
- 2Ω Minimo Impedenza di uscita  
*The minimum load*
- Y Protezione al sovraccarico e sovratemperatura  
*Overload and Overheating protection*
- Y Terminali placati oro  
*Independent gold plated terminals*
- 320x188x56 Dimensioni  
*Product size(mm)*



**Ascolta  
la tua  
musica  
senza cavi**

*Play  
your music  
without  
cables*



**97 BLUETOOTH AMPLIFIER KIT**





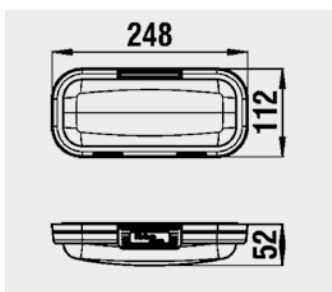
**Copertura impermeabile per autoradio**  
**Waterproof cover case**

**CARATTERISTICHE / KEY FEATURES**

Misure:	248x112x25
<i>Measures:</i>	<i>248x112x25</i>
Materiale	Resistente agli urti e raggi UV
<i>Material:</i>	<i>Waterproof, shock resistant UV resistant</i>

**CODICI ORDINAZIONE / ORDER CODES**

**62.00505.00** Bianco/ *White*



98 WATERPROOF COVER CASE



**CARATTERISTICHE / KEY FEATURES**

Misure: 64x31xH30  
Size: 648x31xH30

Materiale: Legno laccato grigio  
Material: In grey painted wood

Mobile da banco dimostrativo per diffondere la musica via Bluetooth nei locali di vendita ed esposizione e dimostrare alla clientela la qualità degli altoparlanti e dell'amplificatore Riviera.

Fornito già assemblato e pronto al funzionamento, necessita solo di una qualunque batteria o alimentatore (non inclusi) in grado di fornire una tensione di alimentazione tra i 12 e i 14V- 50A di corrente.

Contatta l'Ufficio Commerciale Riviera per le varie opzioni di fornitura.

*The counter cambi display to diffuse the music via Bluetooth in sales and exhibition areas and demonstrate to customers the quality of the Riviera's speakers and amplifier.*

*Supplied already assembled and ready to work, only need any battery or power adapter (not included) able to provide a voltage supply between 12 and 14V- 50A.*

*Pease contact Riviera Sales Office for the different supply options.*





# Riviera

**SISTEMI DI GUIDA MECCANICI**  
***MECHANICAL STEERING SYSTEMS***

---

**MECHANICAL STEERING SYSTEMS**



## COME SCEGLIERE IL SISTEMA DI GUIDA CON TIMONERIA MECCANICA

modalità eaccorgimenti per la scelta della vostratimoneria meccanica

La scelta dell'appropriato sistema di timoneria meccanica è un fattore essenziale per la sicurezza. L'esatta combinazione tra i tipi di forza generate dal tipo di scafo, dalla potenza del motore e dalla velocità della barca: sono determinanti per la scelta corretta oltre che per la sicurezza e l'ottimo funzionamento del sistema.

I motori entro bordo e entrofuoribordo non assistiti, unitamente ad uno scafo di grandi dimensioni, possono generare carichi di forza imponenti sul timone provocando una mancanza di sensibilità sul volante e una scarsa efficienza in termini di risposta alla guida pregiudicando la sicurezza di chi è a bordo; il suggerimento che **RIVIERA S.r.l. GENOVA** propone è quello di montare una delle sue timonerie meccaniche.

Le forze che si generano sulla timoneria e di conseguenza sull'organo di direzione che è il volante, affaticandone la guida e peggiorandone la maneggevolezza, nascono da due fattori: la potenza del propulsore e la velocità dell'imbarcazione; consigliamo pertanto di rivolgersi a personale specializzato ed esperto per trovare il miglior connubio e far sì che l'installazione del prodotto sia eseguita a regola d'arte.

## APPROPRIATE MECHANICAL STEERING SYSTEM SELECTION

suggestions and warnings when selecting a mechanical steering system

*Selection of the appropriate mechanical steering system is an important factor for the safety and functionality of your boat. The combination of engine power, hull type and boat speed influence the correct selection of the steering system.*

*The load on the steering system increases with the boat speed and engine power; the torque generated by the propeller rotation in high power outboard applications can make it hard to steer.*

*Big boats with displacement hulls and inboard or non power assisted stern drive engines, can generate high rudder loads: in these cases a mechanical steering system will be inadequate and we suggest the use of an **RIVIERA S.r.l. GENOVA** mechanical steering system. We always recommend consulting qualified personnel when selecting, installing and maintaining a steering system for your boat.*

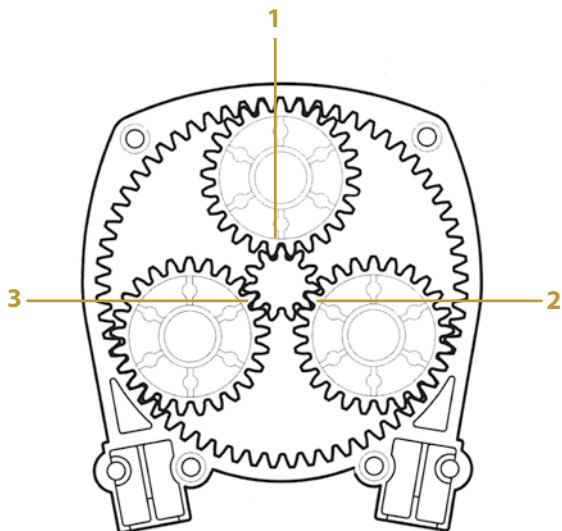
## VANTAGGI DEL SISTEMA PLANETARIO

Le timonerie meccaniche **Riviera**, **SG03** in Delrin e **SG04** in metallo sono state progettate utilizzando il principio di funzionamento **Planetario**. Queste timonerie sono dotate di tre satelliti che compiono una rotazione intorno al proprio asse e contemporaneamente compiono una rivoluzione intorno all'asse centrale.

Il Sistema Planetario permette di distribuire lo sforzo di guida su tre denti dell'ingranaggio centrale suddividendo e bilanciando gli sforzi subito dal sistema. Si ottiene così una più lunga durata del sistema, un'efficienza maggiore rispetto alle timonerie con un solo ingranaggio e una riduzione al minimo dei giochi causati da eccessivi consumi dei componenti.

## ADVANTAGES OF A PLANETARY GEAR DESIGN

**Riviera** mechanical steering helms **SG03** in Delrin material and **SG04** in metal as well use a **Planetary** Gear Design. A Planetary Gear Design has three satellite gears that rotate on their axis and at the same time rotate around the central helm axis. This allows for equal distribution of engine torque over three points of the central gear, dividing and balancing the system loads. The benefits of this special design are increased system longevity, increased efficiency and less engine feedback compared to single pinion gear helms.





## USO E MANUTENZIONE

Il monocavo della timoneria deve essere installato cercando di evitare percorsi tortuosi e curve troppo strette per consentire al guidatore di poter manovrare l'imbarcazione facilmente a tutte le velocità e per ridurre inefficienze e giochi nel sistema.

La corrosione causa il deterioramento dei materiali provocando una perdita dell'efficienza di manovra e, in casi estremi, la rottura del sistema stesso. Seguendo le specifiche fornite dai costruttori dei motori, i terminali del monocavo e il canotto del motore devono essere puliti e lubrificati periodicamente: con queste semplici operazioni si può minimizzare l'usura e la corrosione del sistema.




Il monocavo deve essere ispezionato periodicamente e regolarmente: se lo sforzo di guida dovesse aumentare o si rilevassero incisioni o tagli sulla protezione esterna della guaina o comunque danni ad altre sue componenti, si dovrà sostituirlo immediatamente.

Se si prevede di non utilizzare l'imbarcazione per un lungo periodo, raccomandiamo di togliere il terminale del monocavo dal canotto del motore e di pulirlo adeguatamente.

## USE AND MAINTENANCE

The steering cable must be installed avoiding excessive and/or tight bends. This will provide the driver with easy handling at all speed, helping to reduce inefficiency and excess play in the system. Marine corrosion may cause the materials to deteriorate affecting maneuvering efficiency and in the worst case, system failure. By following the engine manufacturer specifications, the steering cable end fittings and the engine cable support must be cleaned and greased periodically; these simple operations minimize wear and corrosion in the system. The steering cable must be regularly inspected. If steering becomes hard, inconsistent, cuts on the conduit surface are noticed, or any other component found damaged, the cable must be replaced immediately. When storing your boat for an extended period of time we recommend removing the steering cable end fitting from its engine side support and cleaning it adequately.

## GUIDA E RILEVAMENTO DELLA LUNGHEZZA DEL MONOCAVO SELECTION OF STEERING SYSTEMS AND CABLE LENGTH

APPLICAZIONI APPLICATION	POTENZA INSTALLATA ENGINE POWER	TIPO DI TIMONERIA STEERING SYSTEMS
<b>FUORIBORDO / OUTBOARD</b>	fino 35 HP up to 35 HP	<b>SG01</b>
	<b>LUNGHEZZA BARCA BOAT LENGTH</b> fino a 30' (9m) up to 30' (9m)	<b>SG02 SG03 SG04</b>
<b>ENTROBORDO / INBOARD</b>	fino a 35' (10.5m) up to 35' (10.5m)	<b>SG02 SG03 SG04</b>
	<b>ENTROFUORIBORDO / STERNDRIVE</b>	
	fino a 35' (10.5m) up to 35' (10.5m)	<b>SG03 SG04</b>

Si raccomanda comunque di seguire sempre le indicazioni fornite dal costruttore del motore installato.  
Always follow engine manufacturer's instructions.

## COME RILEVARE LA LUNGHEZZA DEL MONOCAVO / PLANETARY GEAR DESIGN

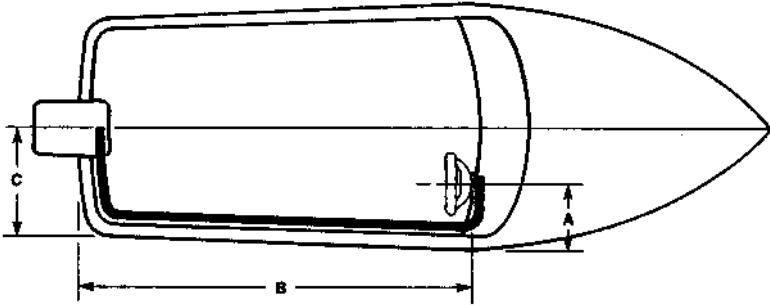
Sommare A+B+C e togliere 10 cm per ciascuna curva del cavo a 90°.

Se il motore è dotato di tubo di fissaggio del monocavo, aggiungere 30,5 cm (1ft) alla lunghezza come sopra ottenuta. Per ottenere la lunghezza in piedi, dividere il risultato per 30,5 ed arrotondare al valore superiore.

*Add. A + B + C and subtract 10 cm (4") for each 90° bend in the cable.*

*For installation through the engine tilt tube, add 30,5 cm (1 ft) to the measure calculated above.*

*To order in foot length, divide by 30,5 and round off to next whole foot.*



## NELLE NUOVE INSTALLAZIONI: NEW STEERING CABLES INSTALLATION:

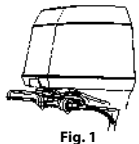


Fig. 1

### FISSAGGIO ATTRAVERSO IL TUBO DEL MOTORE (Fig. 1)

Esempio (le misure sono in cm):  $A (50) + B (250) + C (80) = 380 - 20$  per due curve a  $90^\circ = 360 + 30,5$   
Per fissaggio attraverso il tubo =  $390,5 \text{ cm} : 30,5 = 12,8 \text{ ft}$ . arrotondare a 13 ft.

### TILT TUBE MOUNTING (Fig. 1)

Example (dimensions in cm):  $A (50) + B (250) + C (80) = 380 - 20$  for two  $90^\circ$  bends =  $360 + 30,5$   
For a thru-tube installation  $390,5 \text{ cm} : 30,5 = 12,8 \text{ ft}$ ; round off to 13 ft

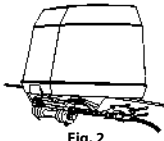


Fig. 2

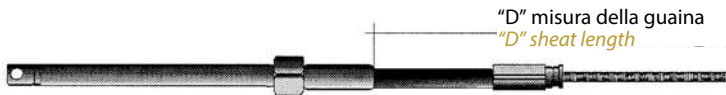
### FISSAGGIO CON STAFFA DI POPPA O A POZZETTO (FIG. 2)

Esempio (le misure sono in cm):  $A (50) + B (250) + C (80) = 380 - 20$  per due curve a  $90^\circ = 360 \text{ cm} : 30,5 = 11,8 \text{ ft}$  arrotondare a 12 ft.

### TRANSOM SUPPORT OR SPLASHWELL MOUNTING (FIG. 2)

Example (dimensions in cm):  $A (50) + B (250) + C (80) = 380 - 20$  for two  $90^\circ$  bends =  $360 : 30,5 = 11,8 \text{ ft}$ ; round off to 12 ft

## COME RILEVARE LA LUNGHEZZA DEL MONOCAVO NEI RICAMBI HOW TO MEASURE FOR NEW STEERING CABLE INSTALLATION



"D" misura della guaina  
"D" sheat length

**LUNGHEZZA DA ORDINARE:** Misura "D" + 56 cm

Per ottenere la lunghezza in piedi, dividere il risultato per 30,5 e arrotondare al valore successivo.

**Esempio:**  $D = 305 \text{ cm} + 56 \text{ cm} = 361 : 30,5 = 11'8"$ . Arrotondare a 12 ft.

**ORDER LENGTH:** "D" dimension + 56 cm

To order in foot length, divide for 30,5 and round up to the next whole foot

**Example:**  $D = 305 \text{ cm} + 56 \text{ cm} = 361 : 30,5 = 11'8"$ . Round up to 12 ft



# T01 (SG01) Monocavi di ricambio Replacement steering cables

TRASMISSIONE PER TIMONERIA MECCANICA / CONTROL CABLE FOR MECHANICAL STEERING HELM



## CARATTERISTICHE / KEY FEATURES

Diametro guaina / Sheat diameter:	14 mm / 14 mm
Corsa / Stroke:	224 mm / 224 mm
Compatibilità / Suitable for:	Universale / Universal

## CODICI ORDINAZIONE / ORDER CODES

**62.00005.00** Indicare, al posto delle ultime due cifre, la lunghezza in piedi desiderata del cavo.  
To order the right cable replace the last two number with the feet length required.

Cert. di esame CE in accordo con le direttive 2013/53/EU

Cavo di comando tiro/spinta per timoneria meccanica.  
Asta timone in acciaio inox.  
Parti metalliche in ottone trattato.  
Cavo spiralato diam. 6 mm.  
Terminale filettato 10-32 UNF.  
Raggio curvatura 200 mm.

Exam Certification CE according to the directive 2013/53/EU

Pull/push control cable suitable for all steering systems helm.  
Stainless steel stock.  
Treated brass metallic parts.  
Spiral cable 6 mm.  
Threaded terminal 10-32 UNF.  
Steering cable bend ra- dius 200 mm.

# T02 (SG02 - SG03 - SG04)

TRASMISSIONE PER TIMONERIA MECCANICA / CONTROL CABLE FOR MECHANICAL STEERING HELM



## CARATTERISTICHE / KEY FEATURES

Diametro guaina / Sheat diameter:	16 mm / 16 mm
Corsa / Stroke:	224 mm / 224 mm
Compatibilità / Suitable for:	Universale / Universal

## CODICI ORDINAZIONE / ORDER CODES

**62.00356.00** Indicare, al posto delle ultime due cifre, la lunghezza in piedi desiderata del cavo.  
To order the right cable replace the last two number with the feet length required.

Cert. di esame CE in accordo con le direttive 2013/53/EU

Cavo di comando tiro/spinta per timoneria meccanica.  
Terminali in acciaio inox.  
Parti metalliche in ottone trattato.  
Cavo spiralato diam. 8 mm.  
Terminale filettato 10-32 UNF.  
Raggio curvatura 200 mm.

Exam Certification CE according to the directive 2013/53/EU

Pull/push control cable suitable for all steering systems helm.  
Stainless steel stock.  
Treated brass metallic parts.  
Spiral cable 8+ mm.  
Threaded terminal 10-32 UNF.  
Steering cable bend ra- dius 200 mm.

### T01

#### CODICI ORDINAZIONE / ORDER CODES 62.00005.00

PIEDI FEET	METRI METER	PIEDI FEET	METRI METER	PIEDI FEET	METRI METER
7	2,1346	19	5,7912	31	9,4488
8	2,4384	20	6,0960	32	9,7536
9	2,7432	21	6,4008	33	10,0584
10	3,0480	22	6,7056	34	10,3632
11	3,3528	23	7,0104	35	10,6680
12	3,6576	24	7,3152	36	10,9728
13	3,9624	25	7,6200	37	11,2776
14	4,2672	26	7,9248	38	11,5824
15	4,5720	27	8,2296	39	11,8872
16	4,8768	28	8,5344	40	12,1920
17	5,1816	29	8,8392		
18	5,4864	30	9,1440		

### T02

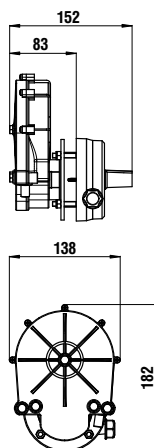
#### CODICI ORDINAZIONE / ORDER CODES 62.00356.00

PIEDI FEET	METRI METER	PIEDI FEET	METRI METER	PIEDI FEET	METRI METER
7	2,1346	19	5,7912	31	9,4488
8	2,4384	20	6,0960	32	9,7536
9	2,7432	21	6,4008	33	10,0584
10	3,0480	22	6,7056	34	10,3632
11	3,3528	23	7,0104	35	10,6680
12	3,6576	24	7,3152	36	10,9728
13	3,9624	25	7,6200	37	11,2776
14	4,2672	26	7,9248	38	11,5824
15	4,5720	27	8,2296	39	11,8872
16	4,8768	28	8,5344	40	12,1920
17	5,1816	29	8,8392		
18	5,4864	30	9,1440		

Indicare al posto delle ultime due cifre, la lunghezza in piedi del cavo. Es: 62.00005.10 corrisponde al cavo tipo T01 da 10 piedi  
For order indicate the code of cable follow to the length in feet and his description. Example: 62.00005.10 Cable T01 type length 10 feet



## SG01 Scatole comando serie titano per timoneria meccanica Steering helm titano series



Cert. di esame CE in accordo con le direttive 2013/53/EU

Costruita interamente con materiali che consentono un'elevata resistenza meccanica e un'inalterabile resistenza all'usura e agli agenti atmosferici. Frizione regolabile tramite manopola esterna.

8 posizioni differenti per permettere l'uscita del cavo nella direzione più conveniente.

**Utilizzare cavi T01**

*Exam Certification CE according to the directive 2013/53/EU*

*High Mechanical resistance. Corrosion resistant material.*

*Standard friction externally adjustable.*

*Eight optional helm positions to facilitate steering cable installation.*

**Use cables T01**

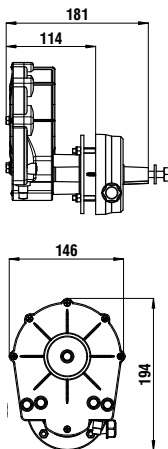
### CARATTERISTICHE / KEY FEATURES

Installazione / <i>Installation:</i>	Incasso / <i>Flush mount</i>
Tipo ingranaggio / <i>Gearing:</i>	Semplice / <i>Standar design</i>
Potenza motore / <i>Engine power:</i>	Fino a 35HP / <i>Up to 35HP</i>
Applicazione / <i>Application:</i>	Fuoribordo fino a 30' (9m) / <i>Outboard up to 30' (9m)</i>

### CODICI ORDINAZIONE / ORDER CODES

**62.00006.00** Nera / *Black*

## SG02 Scatole comando serie titano per timoneria meccanica Steering helm titano series



Cert. di esame CE in accordo con le direttive 2013/53/EU

Costruita interamente con materiali che consentono un'elevata resistenza meccanica e un'inalterabile resistenza all'usura e agli agenti atmosferici. Frizione regolabile tramite manopola esterna.

8 posizioni differenti per permettere l'uscita del cavo nella direzione più conveniente.

**Utilizzare cavi T02**

*Exam Certification CE according to the directive 2013/53/EU*

*High Mechanical resistance. Corrosion resistant material.*

*Standard friction externally adjustable.*

*Eight optional helm positions to facilitate steering cable installation.*

**Use cables T02**

### CARATTERISTICHE / KEY FEATURES

Installazione / <i>Installation:</i>	Incasso / <i>Flush mount</i>
Tipo ingranaggio / <i>Gearing:</i>	Semplice / <i>Standar design</i>
Potenza motore / <i>Engine power:</i>	Oltre i 35HP / <i>Over35 HP</i>
Applicazione / <i>Application:</i>	Fuoribordo fino a 30' (9m) / <i>Outboard up to 30' (9m)</i> Entrobordo fino a 35' (10.5m) / <i>Inboard up to 35' (10.5m)</i>

### CODICI ORDINAZIONE / ORDER CODES

**62.00358.00** Nera / *Black*

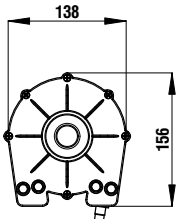
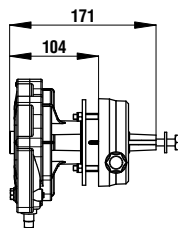


## SG03 Scatole comando serie titano per timoneria meccanica

### Steering helm titano series



**METALLO**  
**METAL**



Cert. di esame CE in accordo con le direttive 2013/53/EU

Costruita interamente con materiali che consentono un'elevata resistenza meccanica e un'inalterabile resistenza all'usura e agli agenti atmosferici. Frizione regolabile tramite manopola esterna. 8 posizioni differenti per permettere l'uscita del cavo nella direzione più conveniente.

**Utilizzare cavi T02**

Exam Certification CE according to the directive 2013/53/EU

High Mechanical resistance. Corrosion resistant material. Standard friction externally adjustable. Eight optional helm positions to facilitate steering cable installation. Use cables T02

#### CARATTERISTICHE / KEY FEATURES

Installazione / *Installation:*

Incasso / *Flush mount*

Tipo ingranaggio / *Gearing:*

A planetario / *Planetary design*

Potenza motore / *Engine power:*

Oltre i 35HP / *Over 35HP*

Applicazione / *Application:*

Fuoribordo fino a 30' (9m) / *Outboard up to 30' (9m)*

Entrobordo fino a 35' (10.5m) / *Inboard up to 35' (10.5m)*

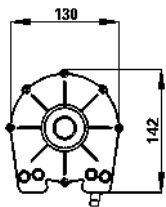
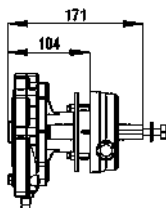
Entrofuoribordo fino a 35' (10.5m) / *Sterndrive up to 35' (10.5m)*

#### CODICI ORDINAZIONE / ORDER CODES

**62.00363.00** Nera / *Black*

## SG04 Scatole comando serie titano per timoneria meccanica

### Steering helm titano series



Cert. di esame CE in accordo con le direttive 2013/53/EU

Costruita interamente con materiali che consentono un'elevata resistenza meccanica e un'inalterabile resistenza all'usura e agli agenti atmosferici. Frizione regolabile tramite manopola esterna. 8 posizioni differenti per permettere l'uscita del cavo nella direzione più conveniente.

**Utilizzare cavi T02**

Exam Certification CE according to the directive 2013/53/EU

High Mechanical resistance. Corrosion resistant material. Standard friction externally adjustable. Eight optional helm positions to facilitate steering cable installation. Use cables T02

#### CARATTERISTICHE / KEY FEATURES

Installazione / *Installation:*

Incasso / *Flush mount*

Tipo ingranaggio / *Gearing:*

A planetario / *Planetary design*

Potenza motore / *Engine power:*

Oltre i 35HP / *Over 35HP*

Applicazione / *Application:*

Fuoribordo fino a 30' (9m) / *Outboard up to 30' (9m)*

Entrobordo fino a 35' (10.5m) / *Inboard up to 35' (10.5m)*

Entrofuoribordo fino a 35' (10.5m) / *Sterndrive up to 35' (10.5m)*

#### CODICI ORDINAZIONE / ORDER CODES

**62.00757.00**



# Riviera

**SISTEMI DI GUIDA MECCANICI:  
KIT DI INSTALLAZIONE**  
***MECHANICAL STEERING SYSTEMS:  
INSTALLATION KIT***

---



**MECHANICAL STEERING SYSTEMS**



## KSG01 Serie titano per timoneria meccanica confezionato in kit Packaged mechanical steering system titano series



Adatto per un sistema di guida che comprende una timoneria e monocavo  
Lungh. max cavo 20 piedi  
**Utilizzare cavi T01**

*Especially suitable for steering with one helm and steering cable Max cable length 20 feet  
Use cables T01*

### CARATTERISTICHE / KEY FEATURES

Timoneria meccanica / <i>Steering helm:</i>	SG01 / SG01
Cavo telecomando / <i>Steering cable:</i>	T01 / T01
Potenza motore / <i>Engine power:</i>	Fino a 35HP / <i>Up to (35HP)</i>
Applicazione / <i>Application:</i>	Fuoribordo fino a 30' (9m) / <i>Outboard up to 30' (9m)</i>

### CODICI ORDINAZIONE / ORDER CODES

**62.00547.00** Indicare, al posto delle ultime due cifre, la lunghezza in piedi desiderata del cavo.  
*To order the right cable replace the last two number with the feet length required.*

## KSG02 Serie titano per timoneria meccanica confezionato in kit Packaged mechanical steering system titano series



Adatto per un sistema di guida che comprende una timoneria e monocavo  
Lungh. max cavo 20 piedi  
**Utilizzare cavi T02**

*Especially suitable for steering with one helm and steering cable Max cable length 20 feet  
Use cables T02*

### CARATTERISTICHE / KEY FEATURES

Timoneria meccanica / <i>Steering helm:</i>	SG02 / SG02
Cavo telecomando / <i>Steering cable:</i>	T02 / T02
Potenza motore / <i>Engine power:</i>	Oltre i 35HP / <i>Over 35HP</i>
Applicazione / <i>Application:</i>	Fuoribordo fino a 30' (9m) / <i>Outboard up to 30' (9m)</i> Entrobordo fino a 35' (10.5m) / <i>Inboard up to 35' (10.5m)</i>

### CODICI ORDINAZIONE / ORDER CODES

**62.00548.00** Indicare, al posto delle ultime due cifre, la lunghezza in piedi desiderata del cavo.  
*To order the right cable replace the last two number with the feet length required.*

### T01 + SG01

#### CODICI ORDINAZIONE / ORDER CODES 62.00547.00

Indicare al posto delle ultime due cifre, la lunghezza in piedi del cavo.  
Es: 62.00547.10 corrisponde al cavo tipo T01 da 10 piedi  
*For order indicate the code of cable follow to the length in feet and his description. For example: 62.00547.10 Cable T01 type length 10 feet*

PIEDI FEET	METRI METER
7	2,1346
8	2,4384
9	2,7432

PIEDI FEET	METRI METER
10	3,0480
11	3,3528
12	3,6576

PIEDI FEET	METRI METER
13	3,9624
14	4,2672
15	4,5720

### T02 + SG02

#### CODICI ORDINAZIONE / ORDER CODES 62.00548.00

Indicare al posto delle ultime due cifre, la lunghezza in piedi del cavo.  
Es: 62.00548.10 corrisponde al Kit con cavo T02 da 10 piedi  
*For order indicate the code of cable follow to the length in feet and his description. For example: 62.00548.10 is the kit KSG02 10 feet (SG02 + cable T02 10 feet)*

PIEDI FEET	METRI METER
16	4,8768
17	5,1816
18	5,4864

PIEDI FEET	METRI METER
19	5,7912
20	6,0960

## KSG03 Serie titano per timoneria meccanica confezionato in kit Packaged mechanical steering system titano series



**METALLO  
METAL**

Adatto per un sistema di guida che comprende una timoneria e monocavo  
Lungh. max cavo 20 piedi  
**Utilizzare cavi T02**

*Especially suitable for steering with one helm and steering cable Max cable length 20 feet  
Use cables T02*

### CARATTERISTICHE / KEY FEATURES

Timoneria meccanica / <i>Steering helm:</i>	SG03 / SG03
Cavo telecomando / <i>Steering cable:</i>	T02 / T02
Potenza motore / <i>Engine power:</i>	Oltre i 35HP / <i>Over 35HP</i>
Applicazione / <i>Application:</i>	Fuoribordo fino a 30' (9m) / <i>Outboard up to 30' (9m)</i> Entrobordo fino a 35' (10.5m) / <i>Inboard up to 35' (10.5m)</i> Entrofuoribordo fino a 35' (10.5m) / <i>Sterndrive up to 35' (10.5m)</i>

### CODICI ORDINAZIONE / ORDER CODES

**62.00549.00** Indicare, al posto delle ultime due cifre, la lunghezza in piedi desiderata del cavo.  
*To order the right cable replace the last two number with the feet length required.*

## KSG04 Serie titano per timoneria meccanica confezionato in kit Packaged mechanical steering system titano series



Adatto per un sistema di guida che comprende una timoneria e monocavo  
Lungh. max cavo 20 piedi  
**Utilizzare cavi T02**

*Especially suitable for steering with one helm and steering cable Max cable length 20 feet  
Use cables T02*

### CARATTERISTICHE / KEY FEATURES

Timoneria meccanica / <i>Steering helm:</i>	SG04 / SG04
Cavo telecomando / <i>Steering cable:</i>	T02 / T02
Potenza motore / <i>Engine power:</i>	Oltre i 35HP / <i>Over 35HP</i>
Applicazione / <i>Application:</i>	Fuoribordo fino a 30' (9m) / <i>Outboard up to 30' (9m)</i> Entrobordo fino a 35' (10.5m) / <i>Inboard up to 35' (10.5m)</i> Entrofuoribordo fino a 35' (10.5m) / <i>Sterndrive up to 35' (10.5m)</i>

### CODICI ORDINAZIONE / ORDER CODES

**62.00758.00** Indicare, al posto delle ultime due cifre, la lunghezza in piedi desiderata del cavo.  
*To order the right cable replace the last two number with the feet length required.*

### T02 + SG03

#### CODICI ORDINAZIONE / ORDER CODES 62.00549.00

Indicare al posto delle ultime due cifre, la lunghezza in piedi del cavo.  
Es: 62.00549.10 corrisponde al Kit con cavo T02 da 10 piedi  
*For order indicate the code of cable follow to the length in feet and his description.  
For example: 62.00549.10 is the kit KSG03 10 feet (SG03 + cable T02 10 feet)*

PIEDI FEET	METRI METER
7	2,1346
8	2,4384
9	2,7432

PIEDI FEET	METRI METER
10	3,0480
11	3,3528
12	3,6576

PIEDI FEET	METRI METER
13	3,9624
14	4,2672
15	4,5720

### T02 + SG04

#### CODICI ORDINAZIONE / ORDER CODES 62.00758.00

Indicare al posto delle ultime due cifre, la lunghezza in piedi del cavo.  
Es: 62.00758.10 corrisponde al Kit con cavo T02 da 10 piedi  
*For order indicate the code of cable follow to the length in feet and his description.  
For example: 62.00758.10 is the kit KSG04 10 feet (SG04 + cable T02 10 feet)*

PIEDI FEET	METRI METER
16	4,8768
17	5,1816
18	5,4864

PIEDI FEET	METRI METER
19	5,7912
20	6,0960





## ACCESSORI CAVI - Soffietti passaguida con cuffia in gomma CABLES ACCESSORIES - Polyurethane bellows for steering cables



### DESCRIZIONE / DESCRIPTION

Soffietto bicono foro d.8. Q.tà minima 5 PZ.  
*Double cable bellows d.8. Minimum quantity 5 PCS.*

**COD. ORDINAZIONE / ORDER COD.**

- 62.00380.01** Nero / Black
- 62.00380.02** Bianco / White
- 62.00380.03** Grigio / Grey



### DESCRIZIONE / DESCRIPTION

Soffietto con flangia foro d.12. Q.tà minima 5 PZ.  
*Flanged bellows d.12. Minimum quantity 5 PCS.*

**COD. ORDINAZIONE / ORDER COD.**

- **62.00381.01** Nero / Black
- **62.00381.02** Bianco / White
- **62.00381.03** Grigio / Grey



### DESCRIZIONE / DESCRIPTION

Soffietto con flangia foro d.12. Q.tà minima 5 PZ.  
*Flanged bellows d.12. Minimum quantity 5 PCS.*

**COD. ORDINAZIONE / ORDER COD.**

- **62.00382.01** Nero / Black
- **62.00382.02** Bianco / White
- **62.00382.03** Grigio / Grey



### DESCRIZIONE / DESCRIPTION

Soffietto foro d.8. Q.tà minima 5 PZ.  
*Bellows d.8. Minimum quantity 5 PCS.*

**COD. ORDINAZIONE / ORDER COD.**

- 62.00384.01** Nero / Black
- 62.00384.02** Bianco / White
- 62.00384.03** Grigio / Grey



### DESCRIZIONE / DESCRIPTION

Soffietto foro d.11. Q.tà minima 5 PZ.  
*Bellows d.11. Minimum quantity 5 PCS.*

**COD. ORDINAZIONE / ORDER COD.**

- **62.00387.01** Nero / Black
- **62.00387.02** Bianco / White
- **62.00387.03** Grigio / Grey



### DESCRIZIONE / DESCRIPTION

Soffietto con fascetta. Q.tà minima 5 PZ.  
*Bellows with clamp. Minimum quantity 5 PCS.*

**COD. ORDINAZIONE / ORDER COD.**

- **62.00383.01** Nero / Black
- **62.00383.02** Bianco / White

## ACCESSORI TIMONERIE / STEERING ACCESSORIES

Snodo per cavi timonerie  
*Joint for steering cable*

**COD. ORDINAZIONE / ORDER COD.**  
**62.00359.00**



Adattatore per scatole UF.  
Compatibile con cavo T01.  
*UF boxes adapter suitable  
for T01 cable*

**COD. ORDINAZIONE / ORDER COD.**  
**62.00512.00**



Snodo per cavi timonerie  
+ staffa di supporto  
*Joint and bracket set  
for steering cable*

**COD. ORDINAZIONE / ORDER COD.**  
**62.00362.00**



Adattatore per montaggio  
timoneria UF T71.  
Compatibile cavo T02.  
*Assembly adapter  
for UF T71 suitable for T02*

**COD. ORDINAZIONE / ORDER COD.**  
**62.00366.00**



## TUBI PASSACAVI / CABLES PASSAGE



Tubo grigio lunghezza 1,20 mt con raccordi neri  
*Grey hose 1,20 mt length with black fittings included*

**COD. ORDINAZIONE / ORDER COD.**  
**62.00800.00**



Tubo grigio lunghezza 0,80 mt con raccordi neri  
*Grey hose 0,80 mt length with black fittings included*

**COD. ORDINAZIONE / ORDER COD.**  
**62.00800.04**



Tubo grigio lunghezza 1,20 mt con raccordi bianchi  
*Grey hose e 1,20 mt length with white fittings included*

**COD. ORDINAZIONE / ORDER COD.**  
**62.00800.10**



Tubo grigio lunghezza 0,80 mt con raccordi bianchi  
*Grey hose 0,80 mt length with white fittings included*

**COD. ORDINAZIONE / ORDER COD.**  
**62.00800.14**



Tubo nero lunghezza 1,20 mt nero con raccordi neri  
*Black hose 1,20 mt length with black fittings included*

**COD. ORDINAZIONE / ORDER COD.**  
**62.00802.00**



Tubo nero lunghezza 0,80 mt nero con raccordi neri  
*Black hose 0,80 mt length with black fittings included*

**COD. ORDINAZIONE / ORDER COD.**  
**62.00802.04**



Tubo nero lunghezza 1,20 mt nero con raccordi bianchi  
*Black hose 1,20 mt length with white fittings included*

**COD. ORDINAZIONE / ORDER COD.**  
**62.00802.10**



Tubo nero lunghezza 0,80 mt nro con raccordi bianchi  
*Black hose 0,80 mt length with white fittings included*

**COD. ORDINAZIONE / ORDER COD.**  
**62.00802.14**



Tubo grigio lunghezza 0,80 mt con soffietto nero  
*Grey hose 0,80 mt length with black fittings*

**COD. ORDINAZIONE / ORDER COD.**  
**62.00801.00**



Tubo grigio lunghezza 0,80 mt soffietto bianco  
*Grey hose 0,80 mt length with white fittings*

**COD. ORDINAZIONE / ORDER COD.**  
**62.00801.10**

Tubo passacavo mt 20  
*Hose 20 mt length*

**COD. ORDINAZIONE**  
**ORDER COD.**

**62.00800.03** Grigio / Grey  
**62.00802.03** Nero / Black



Attacco flangia (conf. 10 PZ.)  
*Flange joint (10 pieces pac.)*

**COD. ORDINAZIONE**  
**ORDER COD.**

**62.00800.11** Bianco / White  
**62.00800.01** Nero / Black



Attacco passacavo (conf. 10 PZ.)  
*Joint for cable (10 pieces pac.)*

**COD. ORDINAZIONE**  
**ORDER COD.**

**62.00800.12** Bianco / White  
**62.00800.02** Nero / Black



# Riviera

**SISTEMI DI GUIDA IDRAULICI**  
**HYDRAULIC STEERING SYSTEMS**

---

**HYDRAULIC STEERING SYSTEMS**





- **Struttura compatta**  
*Compact design*
- **Sistema a pistoni assiali**  
*Bolt bearing pistons race*
- **Dotate di valvola di non-ritorno che impedisce la reversibilità**  
*Built-in lock valve for positive rudder lock*
- **Alberino conico da 3/4" in acciaio inossidabile**  
*3/4" conical stainless steel shaft*
- **Valvola di non-ritorno e guarnizione alberino facilmente accessibili in caso di sostituzione**  
*Easy accessible lock valve and shaft seal for replacement*
- **Rotore costruito in acciaio per una maggiore durata**  
*Elbow fitting helm*
- **Complete di raccordi a gomito**  
*Cast-iron cylinder block*

### PROPRIETÀ DEL SISTEMA DI GUIDA IDRAULICO

Il sistema di guida idraulico della barca è costituito da una pompa posta sul cruscotto, da un cilindro posizionato a poppa e collegato al timone o al motore e da due tubi idraulici di nylon di collegamento. Una rotazione del volante provoca il pompaggio dell'olio che, a seconda del senso di rotazione, affluisce, attraverso uno dei due tubi, ad una delle due camere del cilindro. Il conseguente movimento del pistone sposta il timone dell'imbarcazione cui è collegato lo stelo del cilindro. Le pompe sono dotate di una valvola che ha la funzione d'impedire il flusso dell'olio alla pompa se questa non viene azionata (VALVOLA DI NON RITORNO) ed inoltre rende possibile il funzionamento dei sistemi con due o più stazioni di guida. I cilindri sono a doppia azione e possono essere bilanciati o non bilanciati. I cilindri bilanciati richiedono lo stesso numero di giri del volante per spostare il timone da centro a fine corsa nelle due direzioni opposte.

### HOW THE SYSTEM WORKS

*A hydraulic steering system consists of a steering pump, a cylinder tied to the rudder or to the outboard or stern-drive engine and the connecting nylon or copper tubing. Under normal operating conditions, a turn of the steering wheel will pump the oil through one of the two connecting hydraulic lines into the cylinder's chamber either extending or retracting the cylinder rod. The fluid going out from the other chamber of the cylinder is returned to the helm via the other hydraulic line. There are two basic components in all the hydraulic steering systems: the helm unit and the cylinder, connected by nylon or copper tubing. The helm unit consists of both a hydraulic pump and a valve assembly. The valve assembly prevents outgoing fluid from returning along the same line, isolates each steering station, locks the rudder and eliminates rudder "feedback" to the helm. The cylinders are double acting and be balanced and the wheel needs the same number of turns for both sides.*

### SCELTA DI UN SISTEMA DI GUIDA IDRAULICO

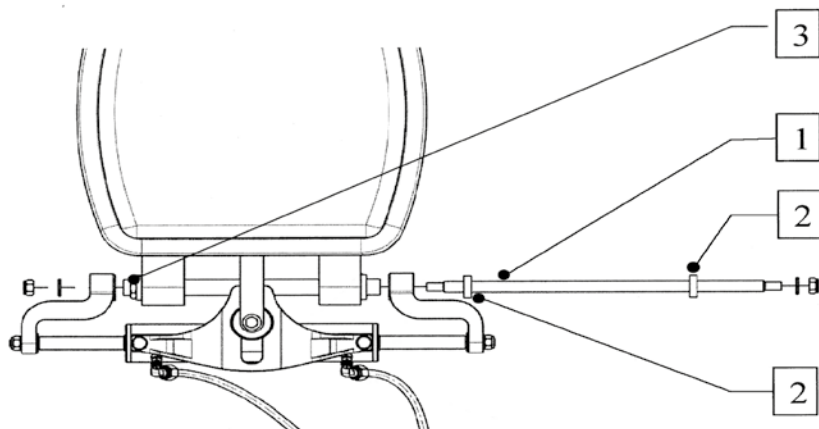
Lo sforzo necessario per guidare un'imbarcazione dotata di un sistema di guida idraulico è inversamente proporzionale al numero di giri del volante da banda a banda. Il numero di giri del volante è determinato dal rapporto fra volume del cilindro, portata della pompa. A parità di cilindro applicato sul motore, minore è il numero di giri del volante, maggiore è lo sforzo per guidare essendo la guida più diretta, mentre con un numero maggiore di giri del volante la guida è demoltiplicata e quindi lo sforzo è inferiore. Altri fattori che influenzano lo sforzo necessario per guidare un'imbarcazione sono:

- La velocità dell'imbarcazione
- La dimensione del timone, o la potenza del motore
- Il tipo di scafo (planante, dislocante, ecc.)
- Le condizioni del mare
- Il tipo di olio utilizzato

### SELECTION OF A HYDRAULIC STEERING SYSTEM

*The strength required to drive a boat equipped with a hydraulic steering system is inversely proportional to the number of turns of the wheel lock-to-lock. The wheel turns are determined by the ratio between the cylinder volume and pump displacement. With the same type of cylinder installed on the engine, the less are the turns, the faster is the response but higher is the effort; more wheel turns, slower is the response and lower is the effort. Other factors that can influence steering effort are:*

- Vessel speed
- Rudder dimension, or engine power
- Hull type (displacement, planing, etc.)
- Sea condition
- Oil type



### CILINDRI FUORIBORDO BILANCIATI DA DIPORTO

I cilindri fuoribordo bilanciati **NON** necessitano di supporti o sostegni da fissare allo scafo.

Collegare i tubi come mostrato in figura.

Collegare la barra del timone alla staffa mediante apposita viteria inclusa.

Assicurarsi che i raccordi per lo spurgo siano correttamente rivolti verso l'alto.

Lubrificare preventivamente l'interno del tubo presente sul motore, inserirvi quindi la barra (1) e sufficienti distanziali plastici (2) fino a centrare il cilindro con l'asse del motore. Bloccare quindi il cilindro stesso in questa posizione agendo sul dado (3) per recuperare eventuali giochi rimanenti. Assicurare la barra (1) al resto del cilindro mediante apposita rondella e dado autobloccante

#### IMPORTANTE

Il cilindro AT12 è un cilindro a doppio effetto per timonerie a montaggio frontale. La pressione massima di esercizio è di 80 bar ed il massimo sforzo applicabile a questa pressione è 195 Kg, il volume massimo del cilindro è di 141 cc.

#### OUTBOARD BALANCED CYLINDER

*The outboard balanced cylinder **NOT** need to be fixed to the hull or support. Connect tubes as shown in figure. Connect tiller arm to bracket using nuts and bolts as included in application kit.*

*Ensure that purge fittings are correctly upward.*

*Lubricate interior of engine tube, insert support rod (1) and sufficient plastic spacers (2) until cylinder is centered to engine center distance.*

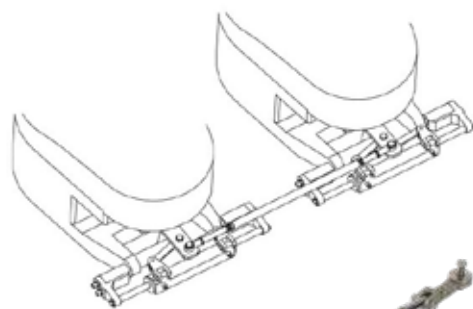
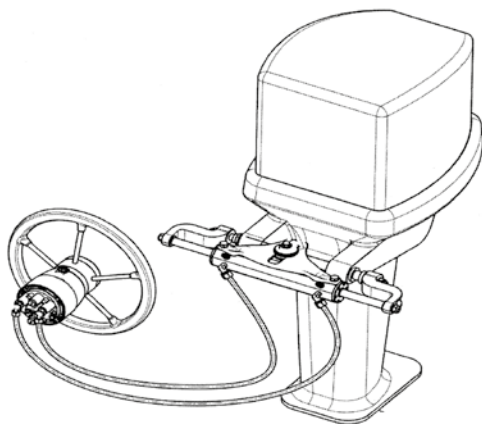
*Block cylinder in position turning nut (3) until tight.*

*Connect support rod (1) to cylinder using washer and self-locking fastener as appropriate.*

#### IMPORTANT

*The cylinder AT12 is a cylinder to double effect for assemblage frontal steerings.*

*The maximum pressure of exercise is of 80 bar and the maximum applicable effort to this pressure is 195 Kg, the maximum volume of the cylinder is of 141 cc.*



Barra accoppiamento 480/615 mm / TIE bar 480/615 mm

**COD. ORDINAZIONE / ORDER COD.**  
**62.00776.00**

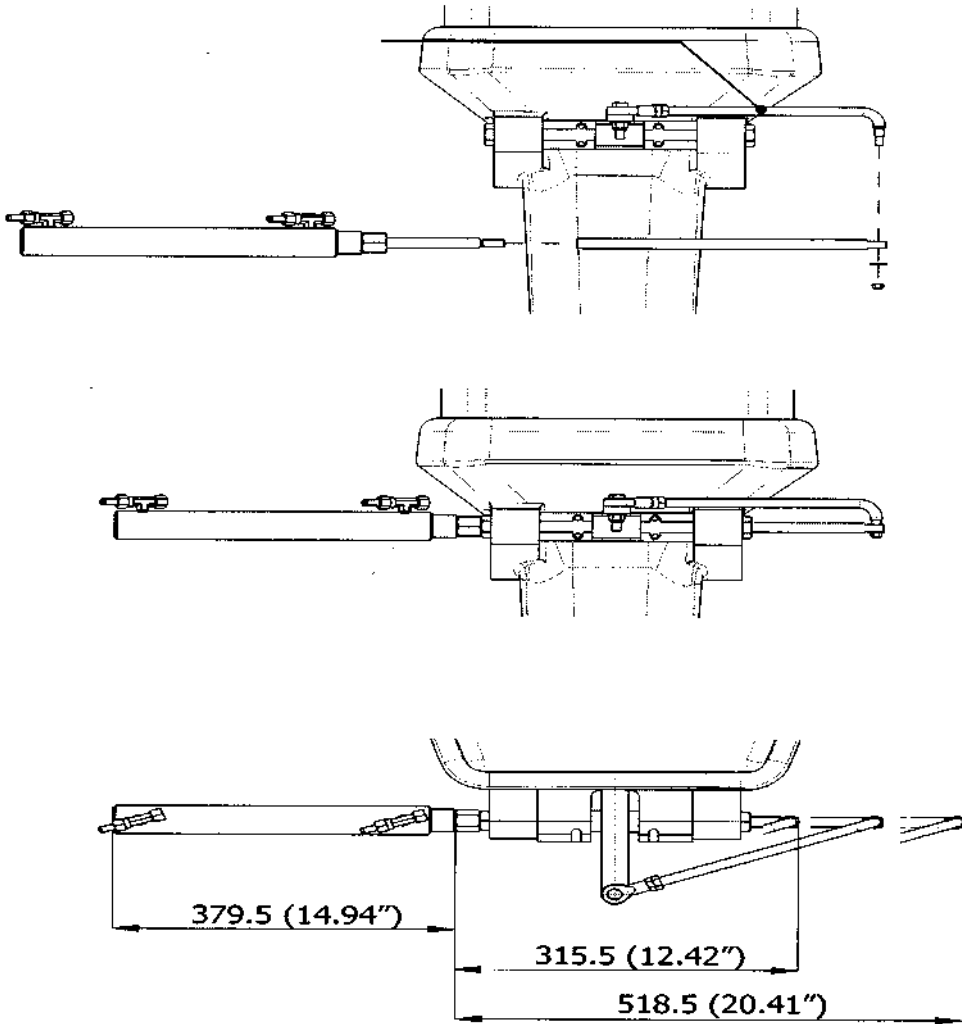


## CILINDRI FUORIBORDO BILANCIATI DA DIPORTO

Lubrificare accuratamente la parte interna del tubo tilt sul motore con grasso marino anticorrosione e installare il cilindro fuoribordo in maniera analoga ai cavi tiro-spinta delle comuni timonerie meccaniche. Avvitare sull'asta del cilindro l'apposita barra-prolunga (inclusa).

## BALANCED OUTBOARD CYLINDER

Carefully lubricate interior of engine tilt tube with anticorrosion marine grease and install outboard cylinder as a mechanical push-pull steering cable. Screw extension rod (included) onto cylinder rod.





## DYNAMIC SERIE KIT FB90

Sistemi di guida per motorizzazioni con motore fuoribordo fino a 90 hp  
*Hydraulic steering package for outboard engine up to 90 hp*

### LA CONFEZIONE KIT FB90 COMPRENDE / **FB90 PACKAGE KIT CONTAINS:**



**62.00846.00**

Cilindro fuoribordo  
*Outboard cylinder*



**62.00844.00**

Pompa 16cc Semi-incasso - 5 pistoni - P. max. 50 Bar  
*Pump 16cc - 5 piston - P. max 50 Bar*



**62.00604.00**

RIVIERA HIDRAX 15 Olio idraulico 2 litri.  
*RIVIERA HIDRAX 15 Hydraulic Oil 2 lt*

**62.00603.70**

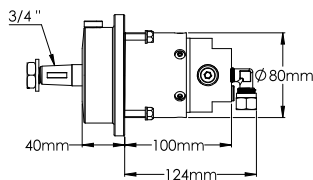
TB7 Coppia tubi flessibili con raccordi preassemblati e 2 raccordi recuperabili. 5/16" - 7 mt (per lunghezze diverse specificare al momento dell'ordine).  
*B7 Hose kit with preassembled fittings and 2 connection recoverable. 5/16" - 7 mt (Specify length required when ordering).*



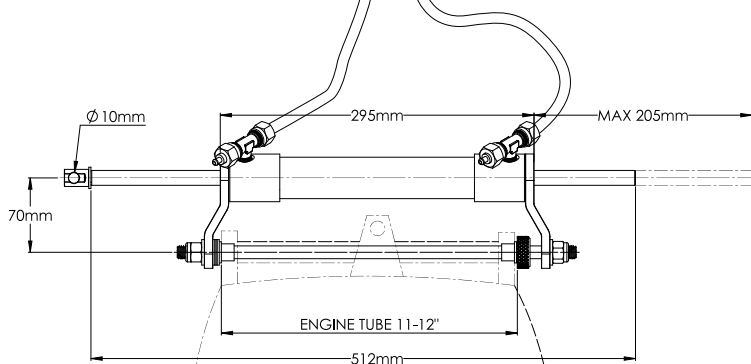
#### CODICI ORDINAZIONE / **ORDER CODES**

**62.00850.00** Confezione KIT FB90 completo / *Complete package KIT FB90*

**62.00850.01** Confezione KIT FB90 completo senza tubi / *Complete package KIT FB90 without hose*



## FINO A / UP TO 90HP



## DYNAMIC SERIE KIT FB150

Sistemi di guida per motorizzazioni con motore fuoribordo fino a 150 hp  
*Hydraulic steering package for outboard engine up to 150 hp*



### LA CONFEZIONE KIT FB150 COMPRENDE / *FB150 PACKAGE KIT CONTAINS:*



**62.00847.00**

Cilindro fuoribordo  
*Outboard cylinder*



**62.00844.00**

Pompa 16cc Semi-incasso - 5 pistoni - P. max. 50 Bar  
*Half-flush Pump 16cc - 5 piston - P. max 50 Bar*



**62.00604.00**

RIVIERA HIDRAX 15 Olio idraulico 2 litri.  
*RIVIERA HIDRAX 15 Hydraulic Oil 2 lt*

#### CARATTERISTICHE

Il sistema di guida KIT FB150 è consigliato indicativamente per imbarcazioni con motori fino a 150HP. N° giri volante 4,3. Il volante non è incluso.

Cert. di esame CE in accordo con le direttive 2013/53/EU

#### FEATURES

KIT FB150 hydraulic steering system is suitable for boat with engine up to 150 HP.

Wheel turn 4.3

The wheel is not included

Exam Certification CE according to the directive 2013/53/EU

**62.00603.70**

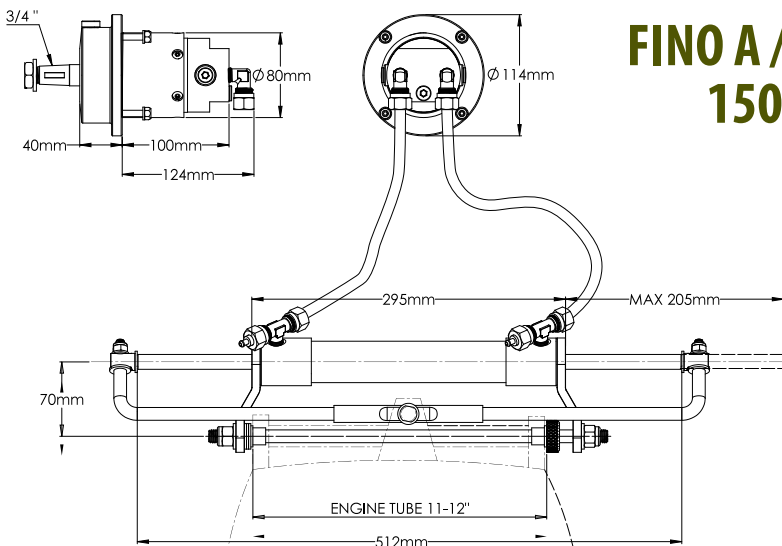
TB7 Coppia tubi flessibili con raccordi preassemblati e 2 raccordi recuperabili. 5/16" - 7 mt (per lunghezze diverse specificare al momento dell'ordine).  
*B7 Hose kit with preassembled fittings and 2 connection recoverable. 5/16"- 7 mt (Specify length required when ordering).*



#### CODICI ORDINAZIONE / *ORDER CODES*

**62.00851.00** Confezione KIT FB150 completo / *Complete package KIT FB150*

**62.00851.01** Confezione KIT FB150 completo senza tubi / *Complete package KIT FB150 without hose*



**FINO A / UP TO  
150HP**



## DYNAMIC SERIE KIT FB250

Sistemi di guida per motorizzazioni con motore fuori bordo fino a 250 hp  
*Hydraulic steering package in kit for outboard engine up to 250 hp*

### LA CONFEZIONE KIT FB250 COMPRENDE / **FB250 PACKAGE KIT CONTAINS:**



**62.00593.00**

**AT12-101** Cilindro fuoribordo  
*AT12-101 Outboard cylinder*



**62.00600.00**

**Pompa 28cc** - 7 pistoni - P. max. 70 Bar  
*Pump 28cc - 7 piston - P. max 70 Bar*



**62.00604.00**

**RIVIERA HIDRAX 15** Olio idraulico 2 litri.  
*RIVIERA HIDRAX 15 Hydraulic Oil 2 lt*

**62.00603.70**

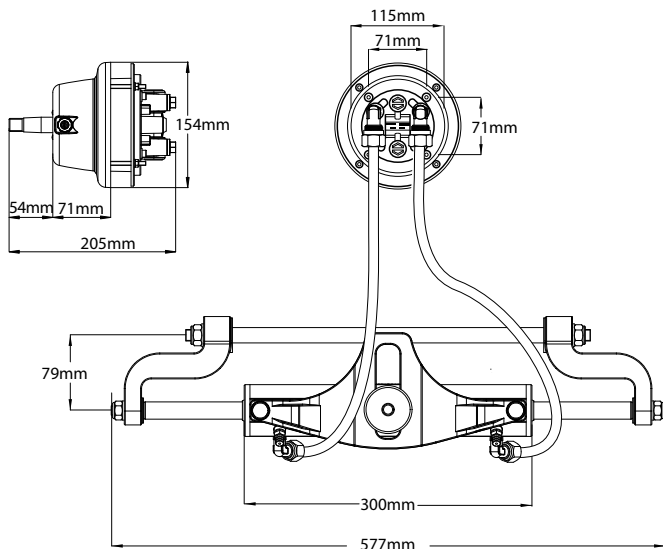
**TB7 Coppia tubi flessibili** con raccordi preassemblati e 2 raccordi recuperabili. **5/16" - 7 mt** (per lunghezze diverse specificare al momento dell'ordine).  
*B7 Hose kit with preassembled fittings and 2 connection recoverable. 5/16" - 7 mt (Specify length required when ordering).*



#### CODICI ORDINAZIONE / **ORDER CODES**

**62.00699.00** Confezione KIT FB250 completo / *Complete package KIT FB250*

**62.00699.01** Confezione KIT FB250 completo senza tubi / *Complete package KIT FB250 without hose*



## FINO A / UP TO 250HP

#### Accessori / **Accessories**



Accessorio per motore  
*Accessories for engine*

HONDA 90/115/130/150 HP  
MERCURY OPTIMAX 115/130 HP

**COD. ORDINAZIONE**  
**ORDER COD.**  
**62.00756.00**

## DYNAMIC SERIE KIT FB350

Sistemi di guida per motorizzazioni con motore fuoribordo fino a 350 hp  
*Hydraulic steering package for outboard engine up to 350 hp*



### LA CONFEZIONE KIT FB350 COMPRENDE / *FB350 PACKAGE KIT CONTAINS:*



**62.00583.00**

**AT12-141** Cilindro fuoribordo  
*AT12-141 Outboard cylinder*



**62.00601.00**

**Pompa 34cc** - 7 pistoni - P. max. 70 Bar  
*Pump 34cc - 7 piston - P. max 70 Bar*



**62.00604.00**

**RIVIERA HIDRAX 15** Olio idraulico 2 litri.  
*RIVIERA HIDRAX 15 Hydraulic Oil 2 lt*

**62.00603.70**

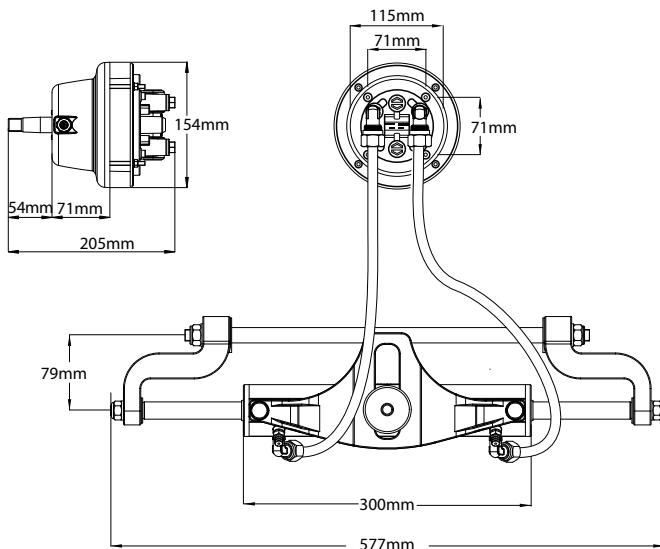
**TB7 Coppia tubi flessibili** con raccordi preassemblati e 2 raccordi recuperabili. **5/16" - 7 mt** (per lunghezze diverse specificare al momento dell'ordine).  
*B7 Hose kit with preassembled fittings and 2 connection recoverable. 5/16"- 7 mt (Specify length required when ordering).*



### CODICI ORDINAZIONE / *ORDER CODES*

**62.00700.00** Confezione KIT FB350 completo / *Complete package KIT FB350*

**62.00700.01** Confezione KIT FB350 completo senza tubi / *Complete package KIT FB350 without hose*



## FINO A / *UP TO* 350HP

### Accessori / *Accessories*



Accessorio per motore  
*Accessories for engine*

HONDA 90/115/130/150 HP  
MERCURY OPTIMAX 115/130 HP

**COD. ORDINAZIONE**  
**ORDER COD.**  
**62.00756.00**

HYDRAULIC STEERING SYSTEMS IN KIT - OUTBOARD





## CILINDRI ENTROBORDO DA DIPORTO BILANCIATI INBOARD BALANCED CYLINDER

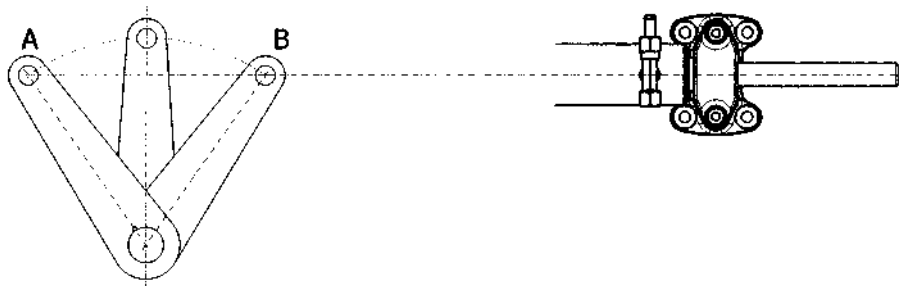
### INSTALLAZIONE DEI CILINDRI / CYLINDER INSTALLATION

Per garantire il buon funzionamento del cilindro, nonché la durata nel tempo di guarnizioni e altre parti usurabili, è necessario prestare molta attenzione in fase di montaggio.

Di seguito viene riportato uno schema che mostra il corretto metodo di installazione:

*To ensure successful cylinder operation and longer durability of seals and over parts subject to wear, it is necessary to use special care in installation.*

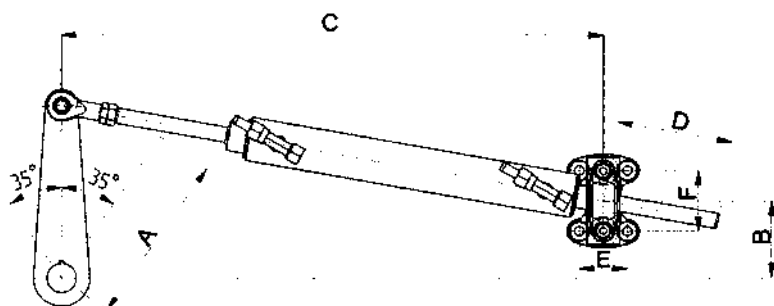
*Correct installation is illustrated in the diagram as follows below:*



Le lettere A e B rappresentano i punti di fine corsa della barra del timone.

Allineare l'ipotetica retta passante per i punti A e B.

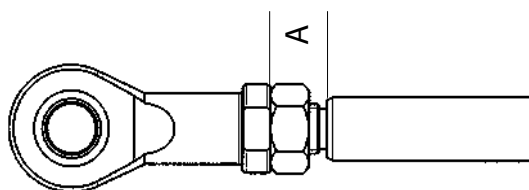
*Letters A and B represent tiller arm hard-over positions. Align AB line to cylinder centerline.*



Le quote indicate con le lettere C e D sono calcolate ipotizzando lo snodo sferico in posizione centrale rispetto alla propria zona di regolazione: è possibile pertanto registrarne la posizione (fino a 3 mm per parte) per correggere eventuali errori di disallineamento.

*C and D dimensions are calculated based on central ball joint relative to its regulation zone.*

*Ball joint position can be adjusted up to 3 mm per side to correct any alignment errors.*



La quota "A" non deve mai essere maggiore a 18 mm

*Dimension 'A' must never be in excess of 18 mm*



## IMPORTANTE / IMPORTANTN

- Il montaggio del pistone sull'imbarcazione deve essere effettuato, se possibile, mediante utilizzo di bulloni passanti da preferire alle viti autofilettanti.  
*Mounting cylinder onto craft must preferably be by through bolts than lag screws.*
- I raccordi per le tubazioni devono essere posti in posizione alta: qualora la natura dell'installazione lo rendesse impossibile, il cilindro deve essere fissato in posizione solo DOPO aver eseguito tutte le procedure di riempimento e spurgo del sistema di seguito riportate.  
*Tube fittings must be in upward position. If not possible, the cylinder should be installed only after filling and purging of the steering systems has been performed as follow below.*
- Proteggere in maniera adeguata lo stelo del cilindro da urti accidentali che potrebbero inficiarne il corretto funzionamento.  
*Adequately protect cylinder rod from accidental collision that may cause steering malfunction.*
- In caso di eventuale corrosione di uno o più particolari (possibile se il cilindro viene impiegato in ambienti particolarmente corrosivi), intervenire per tempo sostituendo le parti intaccate.  
*Corrosion may occur if cylinder utilization is in highly*

## INSTALLAZIONE / INSTALLATION

- Allineare il timone all'asse prua-poppa.  
*Align rudder to boat centerline.*
- Allentare i raccordi per le tubazioni  
*Loosen tube fittings.*
- Posizionare il cilindro sull'imbarcazione facendo riferimento alle dimensioni "B", "C" e "D" dello schema sopra riportato.  
*Posizionare locate cylinder onto craft based on dimensions B, C and D as configured above.*
- Assicurare il montaggio della staffa sul cilindro con 4 bulloni passanti e altrettanti dadi autofrenanti. (non inclusi); utilizzare solo viteria in acciaio inox.  
*Ensure support bracket is mounted onto cylinder by 4 through screws and 4 self locking nuts (not included); only utilize stainless steel nuts and screws.*
- Verificare la libertà di movimento del pistone ruotando completamente il timone. Nelle posizioni di fine corsa l'asse del pistone dovrà trovarsi orizzontale.  
*Check piston movement by turning helm to hard-over in both directions. Piston centerline must be horizontal at both hard-over positions.*



SPONSOR - Nordkapp Rib Mission 2012



## DYNAMIC SERIE KIT EB50

Sistemi di guida per motorizzazioni con motore entroboard fino a 10 mt  
*Hydraulic steering package in kit for inboard engine up to 10 mt*

### LA CONFEZIONE KIT EB50 COMPRENDE / *EB50 PACKAGE KIT CONTAINS:*



**62.00848.00**

Cilindro entroboard  
*Outboard cylinder*



**62.00844.00**

Pompa 16cc Semi-incasso - 5 pistoni - P. max. 50 Bar  
*Pump 16cc - 5 piston - P. max 50 Bar*



**62.00604.00**

RIVIERA HIDRAX 15 Olio idraulico 2 litri.  
*RIVIERA HIDRAX 15 Hydraulic Oil 2 lt*

**62.00603.70**

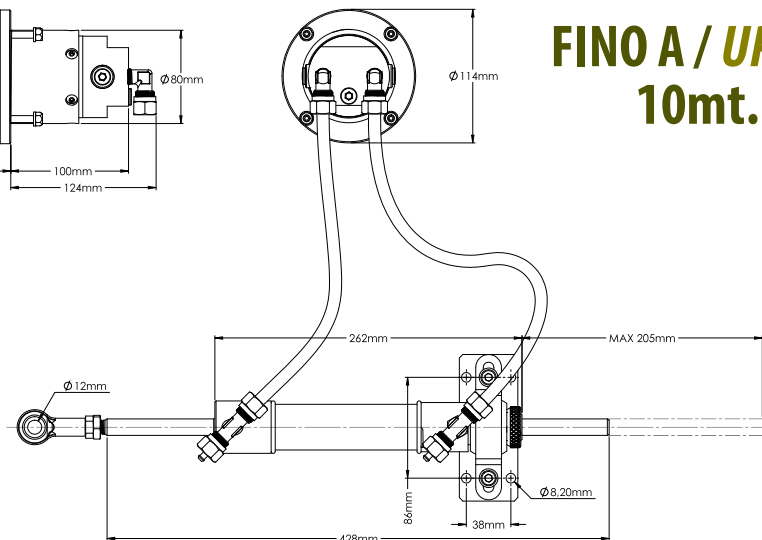
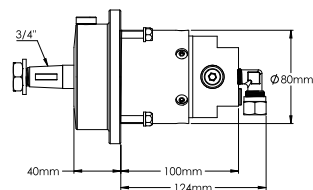
TB7 Coppia tubi flessibili con raccordi preassemblati e 2 raccordi recuperabili. 5/16" - 7 mt (per lunghezze diverse specificare al momento dell'ordine).  
*B7 Hose kit with preassembled fittings and 2 connection recoverable. 5/16" - 7 mt (Specify length required when ordering).*



#### CODICI ORDINAZIONE / *ORDER CODES*

**62.00852.00** Confezione KIT EB50 completo / *Complete package KIT EB50*

**62.00852.01** Confezione KIT EB50 completo senza tubi / *Complete package KIT EB50 without hose*



## FINO A / *UP TO* 10mt.

#### CARATTERISTICHE

Il sistema di guida KIT EB50 è consigliato indicativamente per imbarcazioni con motori fino a 50HP. N° giri volante 5,0  
Il volante non è incluso.

Cert. di esame CE in accordo con le direttive 2013/53/EU

#### FEATURES

KIT EB50 hydraulic steering system is suitable for boat with engine up to 50 HP. Wheel turn 5,0  
The wheel is not included

Exam Certification CE according to the directive 2013/53/EU

## DYNAMIC SERIE KIT EB75

Sistemi di guida per motorizzazioni con motore entro bordo fino a 12 mt  
*Hydraulic steering package in kit for inboard engine up to 12 mt*



### LA CONFEZIONE KIT EB75 COMPRENDE / *EB75 PACKAGE KIT CONTAINS:*



**62.00849.00**

**AT12-101** Cilindro entro bordo  
*AT12-101 Outboard cylinder*



**62.00600.00**

**Pompa 28cc** - 7 pistoni - P. max. 70 Bar  
*Pump 28cc - 7 piston - P. max 70 Bar*



**62.00604.00**

**RIVIERA HIDRAX 15** Olio idraulico 2 litri.  
*RIVIERA HIDRAX 15 Hydraulic Oil 2 lt*

**62.00603.70**

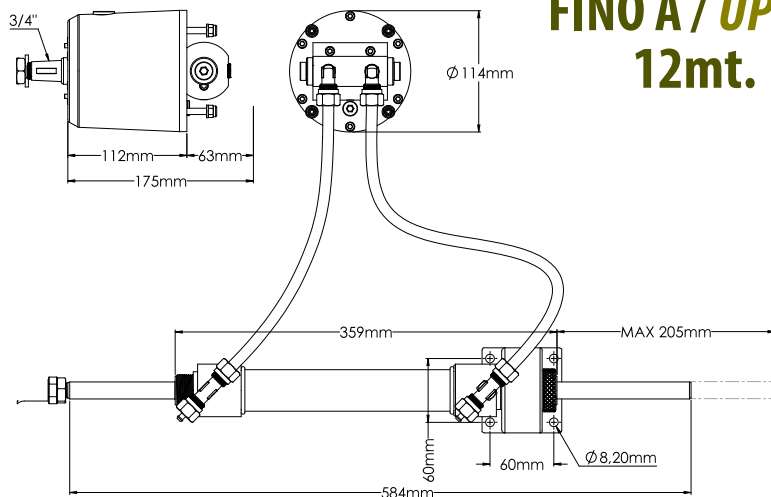
**TB7 Coppia tubi flessibili** con raccordi preassemblati e 2 raccordi recuperabili. **5/16" - 7 mt** (per lunghezze diverse specificare al momento dell'ordine).  
*B7 Hose kit with preassembled fittings and 2 connection recoverable. 5/16" - 7 mt (Specify length required when ordering).*



### CODICI ORDINAZIONE / *ORDER CODES*

**62.00853.00** Confezione KIT EB50 completo / *Complete package KIT EB50*

**62.00853.01** Confezione KIT EB50 completo senza tubi / *Complete package KIT EB50 without hose*

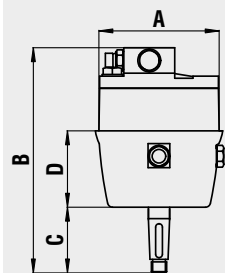


**FINO A / UP TO  
12mt.**

**HYDRAULIC STEERING SYSTEMS IN KIT - INBOARD**



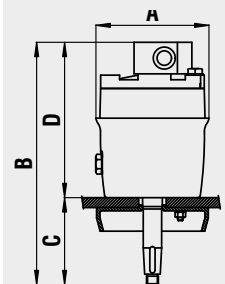
**SERIE HEAVY - Pompa a montaggio frontale imbarcazioni da lavoro**  
*Front mounting pump for fishing and merchants vessels*



**CODICI ORDINAZIONE / ORDER CODES**

	Portata cc/giro <i>Displacement</i>	Pistoni <i>Pistons</i>	Diam. volante <i>Wheel diam.</i>	Peso Kg <i>Weight Kg</i>	P. max Bar <i>P. max Bar</i>	A <i>A</i>	B <i>B</i>	C <i>C</i>	D <i>D</i>
<b>62.00693.00</b>	45	7	500	4,5	100	127	211	38	80
<b>62.00694.00</b>	56	7	600	7,5	100	142	265	77	90
<b>62.00695.00</b>	68	7	700	7,5	100	142	265	77	90
<b>62.00696.00</b>	80	7	800	15	100	172	314	77	121
<b>62.00697.00</b>	100	7	900	15	100	172	314	77	121

**SERIE HEAVY - Pompa a montaggio retrocruscotto imbarcazioni da lavoro**  
*Rear mounting pump for fishing and merchants vessels*

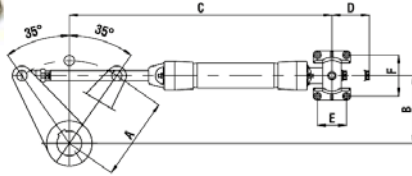


**CODICI ORDINAZIONE / ORDER CODES**

	Portata cc/giro <i>Displacement</i>	Pistoni <i>Pistons</i>	Diam. volante <i>Wheel diam.</i>	Peso Kg <i>Weight Kg</i>	P. max Bar <i>P. max Bar</i>	A <i>A</i>	B <i>B</i>	C <i>C</i>	D <i>D</i>
<b>62.00701.00</b>	45	7	500	4,5	100	127	254	89	165
<b>62.00669.00</b>	56	7	600	7,5	100	142	315	128	187
<b>62.00670.00</b>	68	7	700	7,5	100	142	315	128	187
<b>62.00671.00</b>	80	7	800	15	100	172	369	132	237
<b>62.00672.00</b>	100	7	900	15	100	172	369	132	237



**ATIL5 Cilindri entrobordo bilanciati per imbarcazioni da lavoro**  
*Inboard balanced cylinder for fishing and merchants vessels*



**CARATTERISTICHE**

- Bilanciato: uguale numero di giri da mezza-corsa a fine-corsa
- Raccordi da 1/4
- Camicia in ottone
- Stelo in acciaio cromato

**FEATURES**

- *Balanced: the number of turns lock-to-lock is equal port to starboard or viceversa.*
- *Fittings 1/4*
- *Aluminium anodized liner*
- *Chromium*

**CARATTERISTICHE / KEY FEATURES**

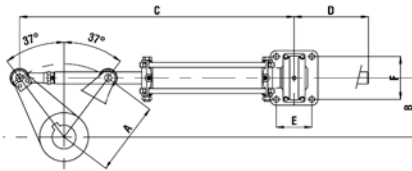
Camicia / <i>Liner</i> :	Ottone / <i>Brass</i>
Stelo / <i>Stem</i> :	Acciaio cromato / <i>Chromium plated steel</i>
Raccordi / <i>Fittings</i> :	1/4 / 1/4

**CODICI ORDINAZIONE / ORDER CODES**

	Diam. mm <i>Diam. mm</i>	Corsa mm <i>Stroke mm.</i>	Spinta Kg <i>Output Kg</i>	Stelo mm <i>Shank mm</i>	Vol. cc <i>Vol. cc</i>	MT kgm <i>MT kgm</i>	A mm <i>A mm</i>	B mm <i>B mm</i>	C mm <i>C mm</i>	D mm <i>D mm</i>	E mm <i>E mm</i>	F mm <i>F mm</i>
<b>62.00677.00</b>	50	300	1473*	25	442	281	260	212	765	311	70	70
<b>62.00679.00</b>	60	250	2195*	30	530	340	218	178	722	263	120	104
<b>62.00680.00</b>	65	300	2611*	30	783	502	260	214	798	283	120	104
<b>62.00702.00</b>	40	160	1472*	25	236	151	139	114	429	107	70	90

\*@ 70 bar

**ATIL6 Cilindri entrobordo bilanciati per imbarcazioni da lavoro**  
*Inboard balanced cylinder for fishing and merchants vessels*



**CARATTERISTICHE**

- Bilanciato: uguale numero di giri da mezza-corsa a fine-corsa
- Raccordi da 1/2
- Camicia in ottone
- Stelo in acciaio cromato

**FEATURES**

- *Balanced: the number of turns lock-to-lock is equal port to starboard or viceversa.*
- *Fittings 1/2*
- *Aluminium anodized liner*
- *Chromium*

**CARATTERISTICHE / KEY FEATURES**

Camicia / <i>Liner</i> :	Ottone / <i>Brass</i>
Stelo / <i>Stem</i> :	Acciaio cromato / <i>Chromium plated steel</i>
Raccordi / <i>Fittings</i> :	1/2 / 1/2

**CODICI ORDINAZIONE / ORDER CODES**

	Diam. mm <i>Diam. mm</i>	Corsa mm <i>Stroke mm.</i>	Spinta Kg <i>Output Kg</i>	Stelo mm <i>Shank mm</i>	Vol. cc <i>Vol. cc</i>	MT kgm <i>MT kgm</i>	A mm <i>A mm</i>	B mm <i>B mm</i>	C mm <i>C mm</i>	D mm <i>D mm</i>	E mm <i>E mm</i>	F mm <i>F mm</i>
<b>62.00683.00</b>	80	300	3678*	40	1130	662	250	200	782	190	120	145
<b>62.00684.00</b>	90	300	5102*	40	1530	918	250	200	782	190	120	145

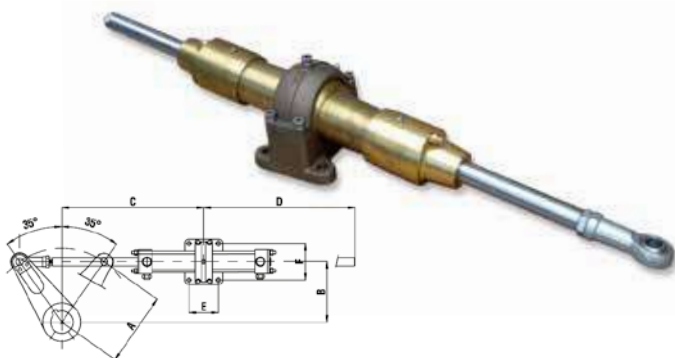
\*@ 70 bar



**HYDRAULIC STEERING SYSTEMS - INBOARD BALANCED CYLINDER**



## ATIL7 Cilindri entro bordo bilanciati per imbarcazioni da lavoro Inboard balanced cylinder for fishing and merchants vessels



### CARATTERISTICHE / KEY FEATURES

Camicia / <i>Liner</i> :	Ottone / <i>Brass</i>
Stelo / <i>Stem</i> :	Acciaio cromato / <i>Chromium plated steel</i>
Raccordi / <i>Fittings</i> :	3/8 (689/690) 1/2 (691/692) / 3/8 (689/690) 1/2 (691/692)

### CODICI ORDINAZIONE / ORDER CODES

	Diam. mm <i>Diam. mm</i>	Corsa mm <i>Stroke mm.</i>	Spinta Kg <i>Output Kg</i>	Stelo mm <i>Shank mm</i>	Vol. cc <i>Vol. cc</i>	MT kgm <i>MT kgm</i>	A mm <i>A mm</i>	B mm <i>B mm</i>	C mm <i>C mm</i>	D mm <i>D mm</i>	E mm <i>E mm</i>	F mm <i>F mm</i>
<b>62.00689.00</b>	50	230	1473*	25	339	217	200	164	412	498	80	100
<b>62.00690.00</b>	50	300	1473*	25	442	281	260	212	506	610	80	100
<b>62.00691.00</b>	60	250	2119*	30	530	340	218	178	454	506	105	130
<b>62.00692.00</b>	65	300	2611*	30	783	502	260	212	504	553	105	130

\*@ 70 bar

### CARATTERISTICHE

- Bilanciato: uguale numero di giri da mezza-corsa a fine-corsa
- Raccordi da 3/8 (689/690) 1/2 (691/692)
- Camicia in ottone
- Stelo in acciaio cromato

### FEATURES

- *Balanced: the number of turns lock-to-lock is equal port to starboard or viceversa.*
- *Fittings 3/8 (685/686) 1/2 (687/688)*
- *Alluminium anodized liner*
- *Chromium plated*

## ATIL8 Cilindri asserviti bilanciati per imbarcazioni da lavoro Inboard servo assisted cylinder for fishing and merchants vessel



### CARATTERISTICHE / KEY FEATURES

Camicia / <i>Liner</i> :	Ottone / <i>Brass</i>
Stelo / <i>Stem</i> :	Acciaio cromato / <i>Chromium plated steel</i>
Raccordi / <i>Fittings</i> :	3/8 (685/686) 1/2 (687/688) / 3/8 (685/686) 1/2 (687/688)

### CODICI ORDINAZIONE / ORDER CODES

	Diam. mm <i>Diam. mm</i>	Corsa mm <i>Stroke mm.</i>	Spinta Kg <i>Output Kg</i>	Stelo mm <i>Shank mm</i>	Vol. cc <i>Vol. cc</i>	MT kgm <i>MT kgm</i>	A mm <i>A mm</i>	B mm <i>B mm</i>	C mm <i>C mm</i>	D mm <i>D mm</i>	E mm <i>E mm</i>	F mm <i>F mm</i>
<b>62.00685.00</b>	---	250	-----	---	339	152	200	156	667	380	70	100
<b>62.00686.00</b>	---	300	-----	---	445	197	260	212	765	380	70	100
<b>62.00687.00</b>	---	250	-----	---	530	238	218	178	722	336	120	104
<b>62.00688.00</b>	---	300	-----	---	783	351	260	212	798	386	120	104

### CARATTERISTICHE

- Bilanciato: uguale numero di giri da mezza-corsa a fine-corsa
- Raccordi da 3/8 (685/686) 1/2 (687/688)
- Camicia in ottone
- Stelo in acciaio cromato

### FEATURES

- *Balanced: the number of turns lock-to-lock is equal port to starboard or viceversa.*
- *Fittings 3/8 (685/686) 1/2 (687/688)*
- *Alluminium anodized liner*
- *Chromium plated*

## COLLEGAMENTO A CILINDRI

I cilindri idraulici RIVIERA sono predisposti con raccorderia a passo 1/4" NPT. Utilizzare tubo flessibile o in rame di diametro esterno 10 mm o tubo terminato con specifici raccordi.

## CONNECTING HOSE TO CYLINDERS

Riviera hydraulic cylinders are supplied with 1/4" NPT fittings. Utilize flexible hose or copper hose with 10 mm outer diameter or specific preinstalled end fittings hose.

## COLLEGAMENTO TUBAZIONI SENZA TERMINALE

Svitare il dado del raccordo presente sul cilindro e rimuovere il cappuccio di protezione. Inserire il dado sul tubo e il tubo all'interno del raccordo portandolo a battuta. Assicurare il montaggio avvitando il dado con apposita chiave (non fornita).

## CONNECTING HOSE TO CYLINDER (NO PREASSEMBLED HOSE END FITTINGS)

Unscrew bolted fitting on cylinder and remove protective cap. Slide nut over hose and insert hose into fitting to bottom. Thread nut tight using wrench (not included).

## COLLEGAMENTO TUBAZIONI CON TERMINALE

Svitare il dado del raccordo presente sul cilindro e rimuovere il cappuccio di protezione. Rimuovere il cappuccio di protezione del terminale sul tubo. Inserire il dado nel terminale e il terminale all'interno del raccordo fino a battuta. Assicurare il montaggio avvitando il dado con l'apposita chiave (non fornita).

## CONNECTING HOSE TO CYLINDER (PREASSEMBLED HOSE END FITTINGS)

Unscrew bolted fitting on cylinder and remove protective cap. Remove protective cap from hose fitting. Slide nut over hose end fitting and hose end fitting into cylinder fitting to bottom. Thread nut tight using wrench (not included).

## COLLEGAMENTO TIMONERIA

Rimuovere i tappi color giallo indicati con la lettera **A** nella figura per collegare la timoneria al pistone idraulico.

Rimuovere i tappi color nero indicati con la lettera **B** nella figura 1 **SOLO** per collegare la timoneria ad eventuali stazioni supplementari.

Utilizzare mastice tipo Loctite 542 o equivalenti per assicurare il serraggio dei raccordi.

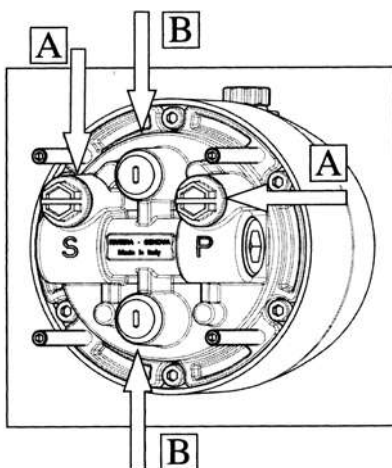
## CONNECTING HOSE TO STEERING HELM

Remove letter **A** yellow caps in side figure to connect steering helm to hydraulic piston..

**ONLY** remove letter **B** black caps in figure to connect steering helm station to second helm station. Utilize sealant Loctite 542 or equivalent to secure tightened fittings.

### ATTENZIONE:

La tenuta dei raccordi deve essere assicurata unicamente mediante l'impegno di materiali liquidi quali Loctite o simili. L'impiego di nastro isolante o teflon potrebbe pregiudicare il corretto funzionamento della timoneria o danneggiarla in modo permanente. Evitare, inoltre, l'immissione nel circuito del materiale liquido di tenuta impiegato.



### CAUTION:

ONLY utilize liquid sealants Loctite or equivalent to secure tightened fittings. Do not use tape or teflon sealers that may cause steering malfunction or permanently damaged steering. Also prevent liquid sealant contaminating the system



## SISTEMA DI GUIDA A STAZIONE SINGOLA

### COLLEGAMENTO AD ATTUATORE CON STELO FISSO

Collegare la bottiglia dell'olio e riempire completamente il serbatoio della timoneria (olio visibile nel tubo trasparente), verificare l'assenza di bolle d'aria.

**Il tubo trasparente dovrà rimanere pieno per tutta la durata dell'operazione, nel caso in cui il contenuto della bottiglia non fosse sufficiente sostituirla con una nuova.**

Per il collegamento ad attuatore con stelo fisso, aprire la valvola di spurgo sul pistone (**vedi schema 1 - fig 2**) e ruotare il volante come illustrato fino alla

completa eliminazione dell'aria:dalla valvola dovrà fuoriuscire SOLO olio.

Chiudere la valvola e continuare a ruotare il volante nella STESSA direzione fino al raggiungimento del fondo corsa.

Aprire la seconda valvola di spurgo e ruotare in direzione contraria alla precedente il volante fino alla totale fuoriuscita dell'aria dalla valvola.

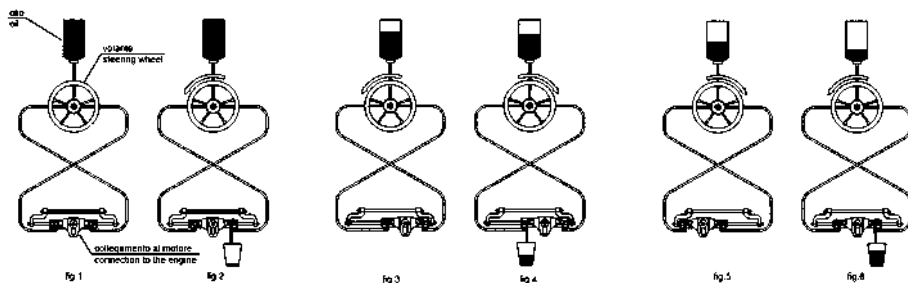
Chiudere la valvola e continuare a ruotare il volante nella stessa direzione fino al raggiungimento del fondo corsa.

Ripetere le operazioni precedenti fino alla totale eliminazione dell'aria residua dal circuito.

### ATTENZIONE:

La rotazione del volante durante le operazioni di riempimento va eseguita LENTAMENTE; l'eccessiva rapidità nella manovra dello stesso potrebbe formare schiuma all'interno del circuito. In questo caso si raccomanda di attendere almeno 24 ore prima di procedere con le operazioni successive.

SCHEMA 1



## SISTEMA DI GUIDA A STAZIONE SINGOLA

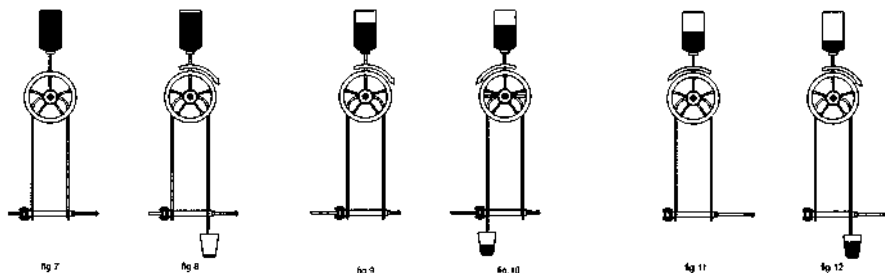
### COLLEGAMENTO AD ATTUATORE CON STELO MOBILE

Per il collegamento ad attuatore con stelo mobile, (**vedi schema 2**) seguire le operazioni descritte per il riempimento per il "collegamento a pistone con stelo fisso" facendo riferimento allo schema corretto.

### ATTENZIONE:

dopo ogni installazione eseguire un check del sistema ruotando il volante diverse volte fino al raggiungimento del fondo corsa prima in un senso e poi nell'altro.

SCHEMA 2



## SINGLE STEERING STATION SYSTEM



### CONNECTION TO FIXED CYLINDER ROD

Connect the oil bottle and fill the tank of the helm (oil visible in the transparent tube), verify the absence of air bubbles.

**The tube transparent must remain fully for the duration of the operation, when the contents of the bottle was not enough to replace it with a new one.**

For connection to fixed cylinder rod open right bleeder on cylinder body (diagram 1 - fig 2) and turn steering

wheel as illustrated until air is completely eliminated: oil ONLY should come out of the bleeder.

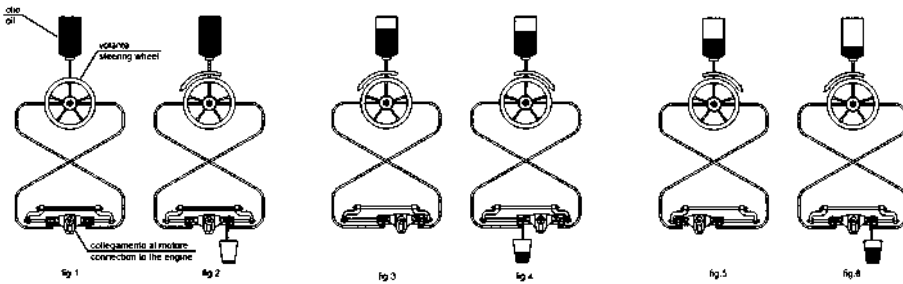
Close bleeder and continue SAME steering wheel rotation until steering wheel comes to halt.

Open the other bleeder and turn steering wheel in opposite direction until air is completely eliminated. Close bleeder and continue same steering wheel rotation until steering wheel comes to halt. Reiterate procedure until complete air elimination.

### CAUTION:

Steering wheel rotation during filling procedures must be SLOW. In the event that excess fastness may cause air bubbles in oil, we recommend you to wait no less than 24 hours before continuing to next steps

DIAGRAM 1



## SINGLE STEERING STATION SYSTEM

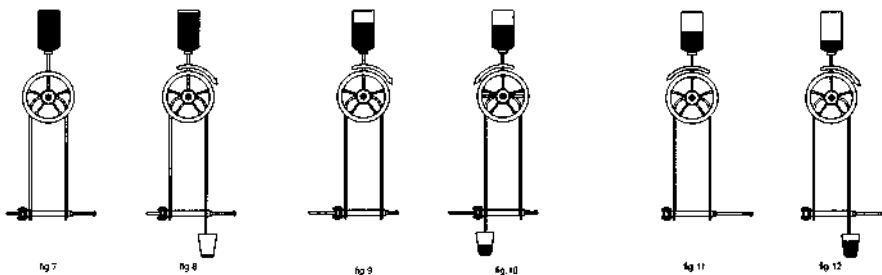
### CONNECTION TO MOBILE CYLINDER ROD

For connection to mobile cylinder rod (diagram 2) follow the steps for filling the "connecting piston rod fixed" by referring to the correct schema.

### CAUTION:

Check proper steering system installation after each procedure. Turn steering wheel until fully stroked in both directions.

DIAGRAM 2





**SISTEMA DI GUIDA A STAZIONE MULTIPLA****COLLEGAMENTO AD ATTUATORE CON STELO FISSO****STAZIONE SINGOLA → PIU' CILINDRI:**

Eseguire il collegamento come mostrato in **schema 3 fig.13**

Procedere come descritto in precedenza (schema 3) agendo passo per passo, prima su un cilindro e successivamente sull'altro fino al completo riempimento del circuito.

**STAZIONI MULTIPLE → PIU' CILINDRI:**

Eseguire il collegamento come mostrato in **schema 3 fig.15**

Procedere come descritto in precedenza (schema 3) agendo passo per passo, prima su un cilindro e successivamente sull'altro, ruotare prima il timone posto più in basso e in seguito quello posto più in alto fino al completo riempimento del circuito.

**STAZIONI MULTIPLE → UN CILINDRO:**

Eseguire il collegamento come mostrato in **schema 3 fig.17**

Procedere come descritto in precedenza (schema 3) ruotando prima il timone posto più in basso e in seguito quello posto più in alto fino al completo riempimento del circuito.

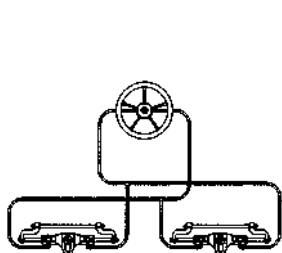
**SCHEMA 3**

Fig. 13

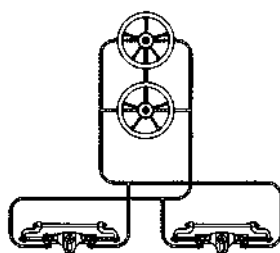


Fig. 15

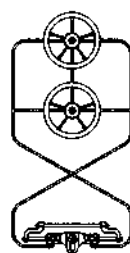


Fig. 17

**SISTEMA DI GUIDA A STAZIONE MULTIPLA****COLLEGAMENTO AD ATTUATORE CON STELO MOBILE****STAZIONE SINGOLA → PIU' CILINDRI:**

Eseguire il collegamento come mostrato in **schema 4 fig.14**

Procedere come descritto in precedenza (schema 4) agendo passo per passo, prima su un cilindro e successivamente sull'altro fino al completo riempimento del circuito.

**STAZIONI MULTIPLE → PIU' CILINDRI:**

Eseguire il collegamento come mostrato in **schema 4 fig.16**

Procedere come descritto in precedenza (schema 4) agendo passo per passo, prima su un cilindro e successivamente sull'altro, ruotare prima il timone posto più in basso e in seguito quello posto più in alto fino al completo riempimento del circuito.

**STAZIONI MULTIPLE → UN CILINDRO:**

Eseguire il collegamento come mostrato in **schema 4 fig.18**

Procedere come descritto in precedenza (schema 4) ruotando prima il timone posto più in basso e in seguito quello posto più in alto fino al completo riempimento del circuito.

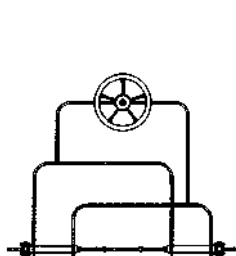
**SCHEMA 4**

Fig. 14

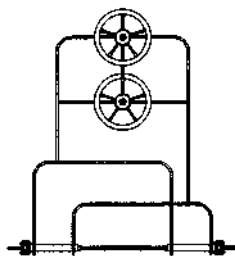


Fig. 16

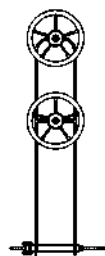


Fig. 18



## MULTIPLE STEERING STATION SYSTEM

### CONNECTION TO FIXED CYLINDER ROD

#### SINGLE STATION → MULTIPLE CYLINDERS:

Perform installation as shown in **diagram 3 fig.13**

Perform steps as in diagram 3, on one cylinder first and then on the other, until system is full.

#### MULTIPLE STATIONS → MULTIPLE CYLINDERS:

Perform connection as shown in **diagram 3 fig.15**

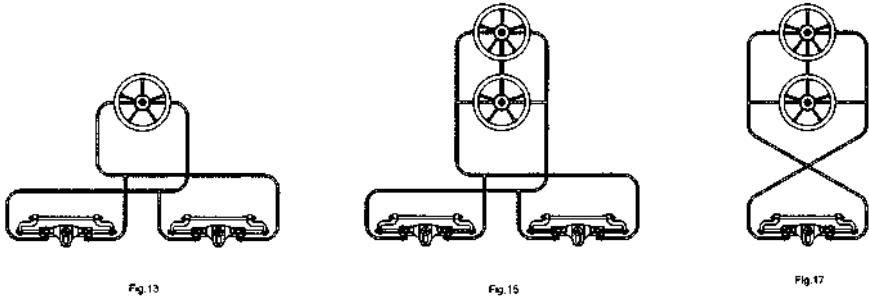
Perform steps as in diagram 3, on one cylinder first and then on the other. Turn steering wheel at helms other than upper station first. Last turn steering wheel at upper helm station, until system is full.

#### MULTIPLE STATIONS → ONE CYLINDER:

Perform connection as shown in **diagram 3 fig.17**

Perform steps as in diagram 3. Turn steering wheel at helms other than upper station first. Last turn steering wheel at upper helm station, until system is full.

### DIAGRAM 3



## MULTIPLE STEERING STATION SYSTEM

### CONNECTION TO MOBILE CYLINDER ROD

#### SINGLE STATION → MULTIPLE CYLINDERS:

Perform installation as shown in **diagram 4 fig.14**

Perform steps as in diagram 3, on one cylinder first and then on the other, until system is full.

#### MULTIPLE STATIONS → MULTIPLE CYLINDERS:

Perform connection as shown in **diagram 4 fig.16**

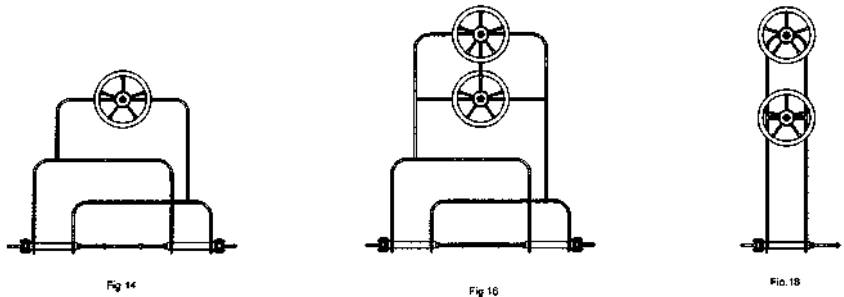
Perform steps as in diagram 3, on one cylinder first and then on the other. Turn steering wheel at helms other than upper station first. Last turn steering wheel at upper helm station, until system is full.

#### MULTIPLE STATIONS → ONE CYLINDER:

Perform connection as shown in **diagram 4 fig.18**

Perform steps as in diagram 3. Turn steering wheel at helms other than upper station first. Last turn steering wheel at upper helm station, until system is full.

### DIAGRAM 4



**OLIO / HYDRAULIC FLUID****CARATTERISTICHE / KEY FEATURES**

Le timonerie **Riviera** utilizzano **ERG HYDRO ISO 15** in conformità con **ISO 15**:

*Riviera steering systems utilize ERG HYDRO ISO 15 in conformity with*

- Densità relativa / *Relative density*: 0.865 gr/cc a 15°C

- Viscosità / *Viscosity*: 15 CST a 40°C

OLI compatibili conformi a **ISO VG 15** in alternativa: / *ISO VG 15 hydraulic fluids are also recommended, as follows:*

**MOBIL DTE 11 ; SHELL TELLUS T15 ; ESSO NUTO H15 ; Q8 HAYDN 15.**

**POMPE / PUMPS****CODICI ORDINAZIONE / ORDER CODES**

	Portata <i>Displac.</i>	n° Pistoni <i>n° Pistons</i>	Peso (Kg) <i>Weight (Kg)</i>	Pressione max <i>Pressure max</i>	Applicazione <i>Mounting position</i>
<b>62.00844.00</b>	16 cc	5	2,1	50 BAR	Semi incasso / <i>Half flush mount</i>
<b>62.00600.00</b>	28 cc	7	5	70 BAR	Semi incasso / <i>Half flush mount</i>
<b>62.00601.00</b>	34 cc	7	5	70 BAR	Semi incasso / <i>Half flush mount</i>

Per imbarcazioni da lavoro / *For fishing and merchants vessel*

<b>62.00693.00</b>	45 cc	7	4,5	100 BAR	Frontale / <i>Front mount</i>
<b>62.00694.00</b>	56 cc		7,5		Frontale / <i>Front mount</i>
<b>62.00695.00</b>	68 cc		7,8		Frontale / <i>Front mount</i>
<b>62.00696.00</b>	80 cc		15		Frontale / <i>Front mount</i>
<b>62.00697.00</b>	100 cc		15		Frontale / <i>Front mount</i>
<b>62.00701.00</b>	45 cc	7	4,5	100 BAR	Retro cruscotto / <i>Rear mount</i>
<b>62.00669.00</b>	56 cc		7,5		Retro cruscotto / <i>Rear mount</i>
<b>62.00670.00</b>	68 cc		7,8		Retro cruscotto / <i>Rear mount</i>
<b>62.00671.00</b>	80 cc		15		Retro cruscotto / <i>Rear mount</i>
<b>62.00672.00</b>	100 cc		15		Retro cruscotto / <i>Rear mount</i>

Raccorderia utilizzata 1/4" NPT; impiegare come sigillante Loctite 542 o Loctite 545.

*Fittings are 1/4" NPT; use sealants Loctite 542 or Loctite 545.*

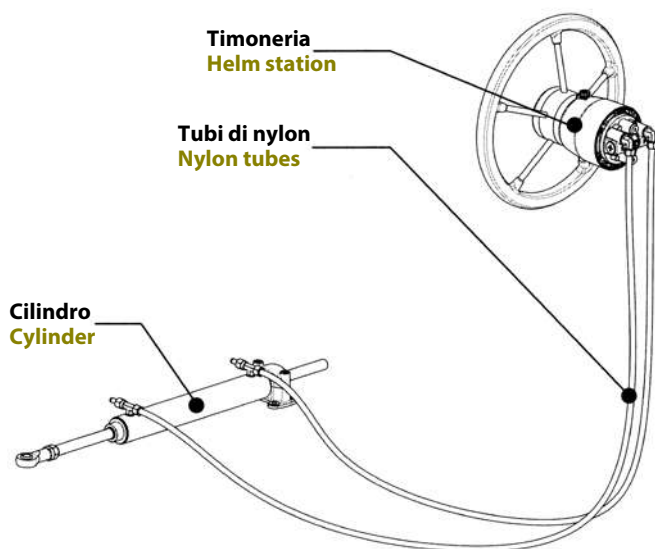
**PISTONI / CYLINDERS****CODICI ORDINAZIONE / ORDER CODES**

	Portata <i>Displac.</i>	Ø Pistone <i>Piston. Ø</i>	Ø Stelo <i>Rod. Ø</i>	P. Max <i>P. Max</i>	Spinta <i>Output force</i>	Corsa <i>Stroke</i>	Applicazione <i>Application</i>
<b>62.00846.00</b>	69cc	38mm	14mm	1161 Psi - 80Bar	250Kg		<b>100HP</b> Fuoribordo/ <i>Outboard</i>
<b>62.00847.00</b>	69cc	38mm	14mm	1160 Psi - 80Bar	250Kg		<b>150HP</b> Fuoribordo/ <i>Outboard</i>
<b>62.00593.00</b>	100cc	30mm*	16mm		354Kg		<b>250HP</b> Fuoribordo/ <i>Outboard</i>
<b>62.00583.00</b>	141cc	35mm*	18mm		495Kg		<b>350HP</b> Fuoribordo/ <i>Outboard</i>
<b>62-00848-00</b>	83cc	40mm	14mm	1000Psi - 70Bar		150mm	<b>Entrobordo / Inboard</b>
<b>62-00849-00</b>	135cc	40mm	16mm	1150Psi - 80Bar		225mm	
<b>62-00677-00</b>	442cc	50mm	25mm		1473kg	300mm	<b>Entrobordo per imbarcazioni da lavoro Inboard for fishing and merchants vessels</b>
<b>62-00679-00</b>	530cc	60mm	30mm		2195kg	250mm	
<b>62-00680-00</b>	783cc	65mm	30mm		2611kg	300mm	
<b>62-00702-00</b>	236cc	40mm	25mm		1472kg	160mm	
<b>62-00683-00</b>	1130cc	80mm	40mm		3678kg	300mm	
<b>62-00684-00</b>	1530cc	90mm	40mm		5102kg	300mm	
<b>62-00689-00</b>	339cc	50mm	25mm		1473kg	230mm	
<b>62-00690-00</b>	442cc	50mm	25mm		1473kg	300mm	
<b>62-00691-00</b>	530cc	60mm	30mm		2119kg	250mm	
<b>62-00692-00</b>	783cc	65mm	30mm		2611kg	300mm	
<b>62-00685-00</b>	339cc					250mm	
<b>62-00686-00</b>	445cc					300mm	
<b>62-00687-00</b>	530cc					250mm	
<b>62-00688-00</b>	783cc					300mm	

Utilizzare per il collegamento tubi in rame o flessibili Riviera.

*Use flexible Riviera hoses or copper tubes to connect steering helm and cylinder and twin steering station installations.*

## SCHEMA DI IMPIANTO A STAZIONE FISSA SINGLE STEERING STATION DIAGRAM



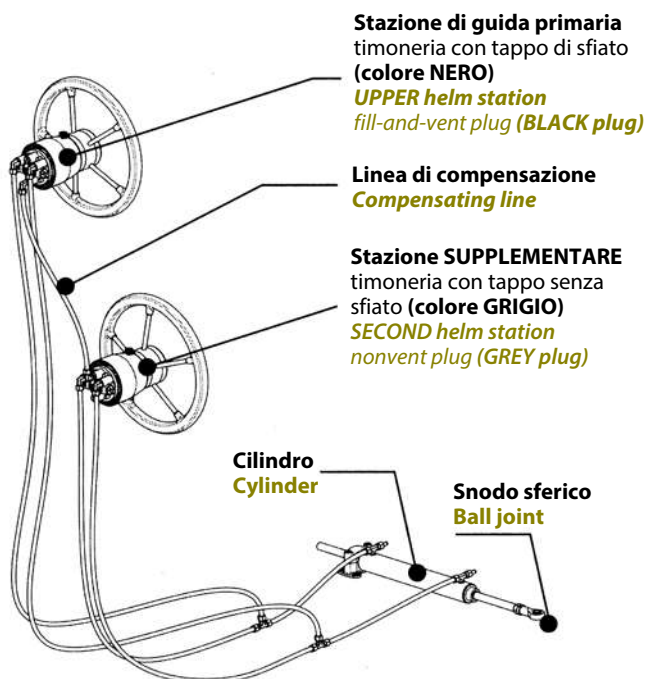
### ATTENZIONE:

Nelle installazioni che impiegano pistone entrobordo e tubazioni in rame (diam. 9.5 mm (3/8"), l'ultimo tratto di collegamento (al cilindro) deve essere realizzato con il Kit **tubi flessibili**.

### CAUTION:

For inboard steering cylinder installation using diam. 9.5 mm (3/8") nylon tubing, use RIVIERA flexible hose kit to connect cylinder end of hydraulic hose

## SCHEMA DI IMPIANTO A STAZIONE MULTIPLA MULTIPLE STEERING STATION DIAGRAM



### ATTENZIONE:

assicurarsi della presenza del tappo senza sfiato GRIGIO. La sua mancanza potrebbe provocare perdita di olio dal circuito e conseguente mal funzionamento.

### CAUTION:

Ensure GREY nonvent plug is in use, to avoid oil leaks and subsequent system malfunction.

# STEERING SYSTEMS - PUMP/PISTON COUPLINGS

134



## TABELLA ACCOPPIAMENTI POMPA/PISTONE PUMP/PISTON COUPLINGS

Cod. Pistone Cod. Piston	V.cc V.cc	Cod. Pompa Cod. Pump	N. Giri N. of turns	Cod. Pompa Cod. Pump	N. Giri N. of turns	Cod. Pompa Cod. Pump	N. Giri N. of turns	Cod. Pompa Cod. Pump	N. Giri N. of turns	Cod. Pompa Cod. Pump	N. Giri N. of turns	Cod. Pompa Cod. Pump	N. Giri N. of turns				
<b>62.00846.00</b>	69	<b>62.00844.00</b>	16	<b>62.00600.00</b>	28	<b>62.00601.00</b>	34	<b>62.00693.00</b> <b>62.00701.00</b>	45	<b>62.00694.00</b> <b>62.00669.00</b>	56	<b>62.00695.00</b> <b>62.00670.00</b>	68	<b>62.00696.00</b> <b>62.00671.00</b>	80	<b>62.00697.00</b> <b>62.00672.00</b>	100
<b>62.00847.00</b>	69		4,3	2,5	2,0	2,0	2,0	1,5	1,5	1,2	1,2	1,0	1,0	0,9	0,9	0,7	0,7
<b>62.00593.00</b>	100		6,3	3,6	2,9	2,9	2,9	2,2	2,2	1,8	1,8	1,5	1,5	1,3	1,3	1,0	1,0
<b>62.00583.00</b>	141		8,8	5,0	4,1	4,1	4,1	3,1	3,1	2,5	2,5	2,1	2,1	1,8	1,8	1,4	1,4
<b>62.00848.00</b>	83		5,2	3,0	2,4	2,4	2,4	1,8	1,8	1,5	1,5	1,2	1,2	1,0	1,0	0,8	0,8
<b>62.00849.00</b>	135		8,4	4,8	4,0	4,0	4,0	3,0	3,0	2,4	2,4	2,0	2,0	1,7	1,7	1,4	1,4
<b>62.00677.00</b>	442		27,6	15,8	13,0	13,0	13,0	9,8	9,8	7,9	7,9	6,5	6,5	5,5	5,5	4,4	4,4
<b>62.00679.00</b>	530		33,1	18,9	15,6	15,6	15,6	11,8	11,8	9,5	9,5	7,8	7,8	6,6	6,6	5,3	5,3
<b>62.00680.00</b>	783		48,9	28,0	23,0	23,0	23,0	17,4	17,4	14,0	14,0	11,5	11,5	9,8	9,8	7,8	7,8
<b>62.00702.00</b>	236		14,8	8,4	6,9	6,9	6,9	5,2	5,2	4,2	4,2	3,5	3,5	3,0	3,0	2,4	2,4
<b>62.00683.00</b>	1130		70,6	40,4	33,2	33,2	33,2	25,1	25,1	20,2	20,2	16,6	16,6	14,1	14,1	11,3	11,3
<b>62.00684.00</b>	1530		95,6	54,6	45,0	45,0	45,0	34,0	34,0	27,3	27,3	22,5	22,5	19,1	19,1	15,3	15,3
<b>62.00689.00</b>	339		21,2	12,1	10,0	10,0	10,0	7,5	7,5	6,1	6,1	5,0	5,0	4,2	4,2	3,4	3,4
<b>62.00690.00</b>	442		27,6	15,8	13,0	13,0	13,0	9,8	9,8	7,9	7,9	6,5	6,5	5,5	5,5	4,4	4,4
<b>62.00691.00</b>	530		33,1	18,9	15,6	15,6	15,6	11,8	11,8	9,5	9,5	7,8	7,8	6,6	6,6	5,3	5,3
<b>62.00692.00</b>	783		48,9	28,0	23,0	23,0	23,0	17,4	17,4	14,0	14,0	11,5	11,5	9,8	9,8	7,8	7,8
<b>62.00685.00</b>	339		21,2	12,1	10,0	10,0	10,0	7,5	7,5	6,1	6,1	5,0	5,0	4,2	4,2	3,4	3,4
<b>62.00686.00</b>	445		27,8	15,9	13,1	13,1	13,1	9,9	9,9	7,9	7,9	6,5	6,5	5,6	5,6	4,5	4,5
<b>62.00687.00</b>	530		33,1	18,9	15,6	15,6	15,6	11,8	11,8	9,5	9,5	7,8	7,8	6,6	6,6	5,3	5,3
<b>62.00688.00</b>	783		48,9	28,0	23,0	23,0	23,0	17,4	17,4	14,0	14,0	11,5	11,5	9,8	9,8	7,8	7,8

Nota bene: gli accoppiamenti evidenziati sono sconsigliati. Per i codici 62.00588.00 e 62.00589.00 notare che le spinte ed i volumi NON sono bilanciati. Vengono indicati in tabella i volumi e i giri volante per le due direzioni. Per la scelta attenersi al n° di giri totale.

Note: the pair shown are not recommended. For codes 62.00588.00 and 62.00589.00 note that the pressures and volumes are NOT balanced. They are given the volumes and the turns of steering wheel for the two directions in the table. For choosing to follow the number of total turns.



**DESCRIZIONE / DESCRIPTION**

Raccordo intermedio 10/8 1/4"  
*Hose union 10/8 1/4"*

prezzo a conf. 5 PZ.  
*price per 5 pieces package*



**COD.ORDINAZIONE / ORDER COD.**  
**62.00706.00**

**DESCRIZIONE / DESCRIPTION**

Raccordo a T centrale 10/8 1/4"  
*T union 10/8 1/4"*

prezzo a conf. 5 PZ.  
*price per 5 pieces package*



**COD.ORDINAZIONE / ORDER COD.**  
**62.00709.00**

**DESCRIZIONE / DESCRIPTION**

Anima di rinforzo 10/8  
*Cap plug 10/8*

prezzo a conf. 5 PZ.  
*price per 5 pieces package*



**COD.ORDINAZIONE / ORDER COD.**  
**62.00711.00**

**DESCRIZIONE / DESCRIPTION**

Raccordo dritto 10/8 1/4" F/F  
*Connector fitting F/F 10/8 1/4"*

prezzo a conf. 5 PZ.  
*price per 5 pieces package*



**COD.ORDINAZIONE / ORDER COD.**  
**62.00713.00**

**DESCRIZIONE / DESCRIPTION**

Raccordo dritto 3/8" nichelato  
*Nickel-plated connector fitting 3/8"*

prezzo a conf. 5 PZ.  
*price per 5 pieces package*



**COD.ORDINAZIONE / ORDER COD.**  
**62.00607.00**

**DESCRIZIONE / DESCRIPTION**

Raccordo a T 3/8 nichelato  
*Nickel-plated T union 3/8"*

prezzo a conf. 5 PZ.  
*price per 5 pieces package*



**COD.ORDINAZIONE / ORDER COD.**  
**62.00609.00**

**DESCRIZIONE / DESCRIPTION**

Raccordo a gomito 10/8 1/4"  
*Elbow fitting 10/8 1/4"*

prezzo a conf. 5 PZ.  
*price per 5 pieces package*



**COD.ORDINAZIONE / ORDER COD.**  
**62.00707.00**

**DESCRIZIONE / DESCRIPTION**

Raccordo a T intermedio 10/8  
*T union 10/8 1/4"*

prezzo a conf. 5 PZ.  
*price per 5 pieces package*



**COD.ORDINAZIONE / ORDER COD.**  
**62.00710.00**

**DESCRIZIONE / DESCRIPTION**

Raccordo dritto 10/8 1/4" F/M  
*Connector fitting F/M 10/8 1/4"*

prezzo a conf. 5 PZ.  
*price per 5 pieces package*



**COD.ORDINAZIONE / ORDER COD.**  
**62.00712.00**

**DESCRIZIONE / DESCRIPTION**

Valvola a sfera 10/8 1/4" F/F  
*Ball valve F/F 10/8 1/4"*

prezzo a conf. 5 PZ.  
*price per 5 pieces package*



**COD.ORDINAZIONE / ORDER COD.**  
**62.00714.00**

**DESCRIZIONE / DESCRIPTION**

Raccordo a gomito 3/8" nichelato  
*Nickel-plated elbow fitting 3/8"*

prezzo a conf. 5 PZ.  
*price per 5 pieces package*



**COD.ORDINAZIONE / ORDER COD.**  
**62.00608.00**

**DESCRIZIONE / DESCRIPTION**

Raccordo a cilindro a T per spurgo 3/8 nichelato  
*Bleed T for cylinder nickel-plated 3/8"*

prezzo a conf. 5 PZ.  
*price per 5 pieces packages*

**COD.ORDINAZIONE / ORDER COD.**  
**62.00610.00**





## DESCRIZIONE / DESCRIPTION

Dado con ogiva  
Nut and sleeve assembly

prezzo a conf. 4 PZ  
price per 4 pieces package



**COD.ORDINAZIONE / ORDER COD.**  
**62.00621.00**

## DESCRIZIONE / DESCRIPTION

Kit per applicazione  
tubo rame d.10  
Copper tube fitting kit Diam.10



**COD.ORDINAZIONE / ORDER COD.**  
**62.00624.00**

## DESCRIZIONE / DESCRIPTION

Valvola  
By-pass



**COD.ORDINAZIONE / ORDER COD.**  
**62.00626.00**

## DESCRIZIONE / DESCRIPTION

Raccordo recuperabile per  
tubo rinforzato flessibile 5/16"  
Connection recoverable for  
reinforced flexible hose 5/16"



prezzo a conf. 4 PZ  
price per 4 pieces package

**COD.ORDINAZIONE / ORDER COD.**  
**62.00771.00**

## DESCRIZIONE / DESCRIPTION

Kit guarnizioni per cilindro  
fuoribordo 350 HP  
350 HP outboard cylinder  
Head Gasket kit



**COD.ORDINAZIONE / ORDER COD.**  
**61.01129.00**

## DESCRIZIONE / DESCRIPTION

Kit guarnizioni per cilindro  
fuoribordo 250 HP  
250 HP outboard cylinder  
Head Gasket kit



**COD.ORDINAZIONE / ORDER COD.**  
**61.01132.00**

## DESCRIZIONE / DESCRIPTION

Kit di riempimento  
Filling kit



**COD.ORDINAZIONE / ORDER COD.**  
**62.00597.00**

## DESCRIZIONE / DESCRIPTION

Kit stazione aggiuntiva  
Second steering fitting kit



**COD.ORDINAZIONE / ORDER COD.**  
**62.00625.00**

## DESCRIZIONE / DESCRIPTION

Serie raccordi per  
tubo rame 3/8"  
Copper tube fittings 3/8"



**COD.ORDINAZIONE / ORDER COD.**  
**62.00627.00**

## DESCRIZIONE / DESCRIPTION

Hydrax 15 - 1 lt  
Hydrax 15 - 1 lt



**COD.ORDINAZIONE / ORDER COD.**  
**62.00604.00**



COD.ORDINAZIONE / **ORDER COD.**

**62.00619.00** Tubo rinforzato flessibile R7 5/16"  
*Reinforced flexible hose R7 5/16"*

prezzo al metro / *price per meter*



COD.ORDINAZIONE / **ORDER COD.**

**62.00620.00** Tubo rinforzato 3/8"  
*Reinforced hose 3/8"*

prezzo al metro / *price per meter*



COD.ORDINAZIONE / **ORDER COD.**

**62.00603.30** Tubo flessibile con raccordi preassemblati mt 3,00  
*Flexible hose with preassembled fittings mt 3,00*

**62.00603.35** Tubo flessibile con raccordi preassemblati mt 3,50  
*Flexible hose with preassembled fittings mt 3,50*

**62.00603.40** Tubo flessibile con raccordi preassemblati mt 4,00  
*Flexible hose with preassembled fittings mt 4,00*

**62.00603.45** Tubo flessibile con raccordi preassemblati mt 4,50  
*Flexible hose with preassembled fittings mt 4,50*

**62.00603.50** Tubo flessibile con raccordi preassemblati mt 5,00  
*Flexible hose with preassembled fittings mt 5,00*

**62.00603.55** Tubo flessibile con raccordi preassemblati mt 5,50  
*Flexible hose with preassembled fittings mt 5,50*

**62.00603.60** Tubo flessibile con raccordi preassemblati mt 6,00  
*Flexible hose with preassembled fittings mt 6,00*

**62.00603.65** Tubo flessibile con raccordi preassemblati mt 6,50  
*Flexible hose with preassembled fittings mt 6,50*

**62.00603.70** Tubo flessibile con raccordi preassemblati mt 7,00  
*Flexible hose with preassembled fittings mt 7,00*

**62.00603.75** Tubo flessibile con raccordi preassemblati mt 7,50  
*Flexible hose with preassembled fittings mt 7,50*

**62.00603.80** Tubo flessibile con raccordi preassemblati mt 8,00  
*Flexible hose with preassembled fittings mt 8,00*

**62.00603.85** Tubo flessibile con raccordi preassemblati mt 8,50  
*Flexible hose with preassembled fittings mt 8,50*

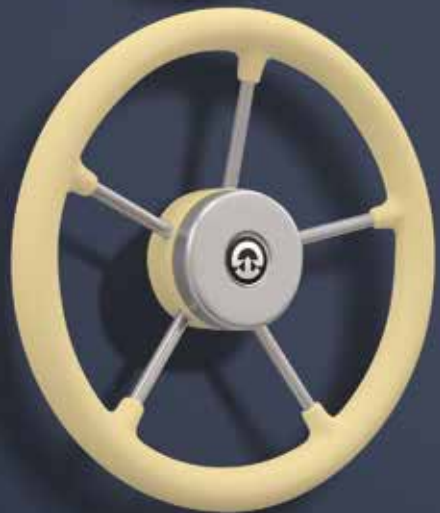
**62.00603.90** Tubo flessibile con raccordi preassemblati mt 9,00  
*Flexible hose with preassembled fittings mt 9,00*



**Riviera**

**VOLANTI  
STEERING WHEELS**

---



**STEERING WHEELS**

# VR01



BIANCO / WHITE



GRIGIO / GREY



SABBIA / SAND



## DESCRIZIONE / DESCRIPTION

Diametro / Diameter: 325 / 325

Impugnatura / Grip: Megol / Megol

Razze / Spokes: Acciaio inox / Stainless steel

Cert. di esame CE in accordo con le direttive 2013/53/EU

Exam Certification CE according to the directive 2013/53/EU SAFETY STANDARDS.

## CODICE ORDINAZIONE / ORDER CODES

62.00538.00 Nero / Black

62.00538.01 Bianco / White

62.00538.02 Grigio / Grey

62.00538.03 Sabbia / Sand

# VR02



BIANCO / WHITE



GRIGIO / GREY



SABBIA / SAND

## DESCRIZIONE / DESCRIPTION

Diametro / Diameter: 350 / 350

Impugnatura / Grip: Megol / Megol

Razze / Spokes: Acciaio inox / Stainless steel

Cert. di esame CE in accordo con le direttive 2013/53/EU

Exam Certification CE according to the directive 2013/53/EU SAFETY STANDARDS.

## CODICE ORDINAZIONE / ORDER CODES

62.00499.00 Nero / Black

62.00499.01 Bianco / White

62.00499.02 Grigio / Grey

62.00499.03 Sabbia / Sand

# VR03



BIANCO / WHITE



GRIGIO / GREY

## DESCRIZIONE / DESCRIPTION

Diametro / Diameter: 400 / 400

Impugnatura / Grip: Megol / Megol

Razze / Spokes: Acciaio inox / Stainless steel

Cert. di esame CE in accordo con le direttive 2013/53/EU

Exam Certification CE according to the directive 2013/53/EU SAFETY STANDARDS.

## CODICE ORDINAZIONE / ORDER CODES

62.00497.00 Nero / Black

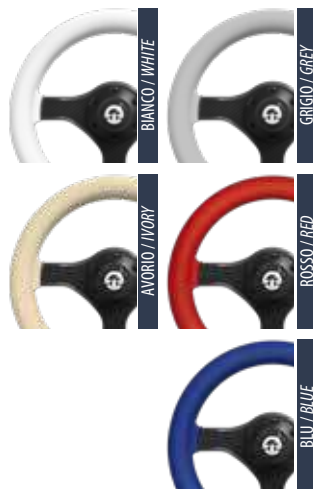
62.00497.01 Bianco / White

62.00497.02 Grigio / Grey





# VR00



## DESCRIZIONE / DESCRIPTION

**Diametro / Diameter:** 280 / 280

**Impugnatura / Grip:** Megol effetto pelle / Megol leather effect

**Razze / Spokes:** PP effetto carbonio / PP carbon effect

## CODICE ORDINAZIONE / ORDER CODES

**62.00784.00** Nero / Black

**62.00784.01** Bianco / White

**62.00784.02** Grigio / Grey

**62.00784.03** Avorio / Ivory

**62.00784.04** Rosso / Red

**62.00784.05** Blu / Blue

Conforme alle normative UNI EN 28848  
UNI EN 29775 - UNI EN ISO 10592  
Mozzo con attacco universale.

*In conformity with the UNI EN 28848  
UNI EN 29775 - UNI EN ISO 10592 STANDARDS.  
about leisure boats. Standard Hub.*

# VR04



## DESCRIZIONE / DESCRIPTION

**Diametro / Diameter:** 350 / 350

**Impugnatura / Grip:** Megol effetto pelle / Megol leather effect

**Razze / Spokes:** PP effetto carbonio / PP carbon effect

## CODICE ORDINAZIONE / ORDER CODES

**62.00863.00** Nero / Black

**62.00863.01** Bianco / White

**62.00863.02** Grigio / Grey

Conforme alle normative UNI EN 28848  
UNI EN 29775 - UNI EN ISO 10592  
Mozzo con attacco universale.

*In conformity with the UNI EN 28848  
UNI EN 29775 - UNI EN ISO 10592 STANDARDS.  
about leisure boats. Standard Hub.*

# VS01



## DESCRIZIONE / DESCRIPTION

Diametro / Diameter: 350 / 350

Impugnatura / Grip: Poliuretano-Mogano-Teak / Polyurethane-Mahogany-Teak

Razze / Spokes: Acciaio inox / Stainless steel

## CODICE ORDINAZIONE / ORDER CODES

- 62.00722.00** Nero / Black
- 62.00722.01** Grigio / Grey
- 62.00722.02** Bianco / White
- 62.00722.03** Avorio / Ivory
- 62.00722.04** Mogano / Mahogany
- 62.00722.05** Teak / Teak

Cert.di esame CE tipo N.DIP 26897  
Conforme alle normative  
UNI EN 28848 - UNI EN 29775

In conformity with the UNI EN 28848  
UNI EN 29775 - UNI EN ISO 10592 STANDARDS.

# VS02



## DESCRIZIONE / DESCRIPTION

Diametro / Diameter: 350 / 350

Impugnatura / Grip: Poliuretano-Carbonio-Inox-Mogano / Polyurethane-Carbon-Inox-Mahogany

Razze / Spokes: Acciaio inox / Stainless steel

## CODICE ORDINAZIONE / ORDER CODES

- 62.00723.00** Carbonio / Carbon
- 62.00723.01** Inox / Inox
- 62.00723.02** Mogano / Mahogany
- 62.00723.03** Bianco / White
- 62.00723.04** Nero / Black
- 62.00723.05** Avorio / Ivory

Cert.di esame CE tipo N.DIP 26897  
Conforme alle normative  
UNI EN 28848 - UNI EN 29775

In conformity with the UNI EN 28848  
UNI EN 29775 - UNI EN ISO 10592 STANDARDS.



# VS03



## DESCRIZIONE / DESCRIPTION

Diametro / Diameter: 350 / 350

Impugnatura / Grip: Mogano-Poliuretano / Mahogany-Polyurethane

Razze / Spokes: Acciaio inox / Stainless steel

## CODICE ORDINAZIONE / ORDER CODES

**62.00724.00** Mogano / Mahogany

**62.00724.01** Bianco / White

**62.00724.02** Avorio / Ivory

**62.00724.03** Grigio / Grey

**62.00724.04** Nero / Black

Cert.di esame CE tipo N.DIP 26897  
Conforme alle normative  
UNI EN 28848 - UNI EN 29775

In conformity with the UNI EN 28848  
UNI EN 29775 - UNI EN ISO 10592 STANDARDS.

# VS11



## DESCRIZIONE / DESCRIPTION

Diametro / Diameter: 350 / 350

Impugnatura / Grip: Poliuretano / Polyurethane

Razze / Spokes: Alluminio anodizzato / Anodized aluminum

## CODICE ORDINAZIONE / ORDER CODES

**62.00838.00** Nero / Black

**62.00838.01** Bianco / White

**62.00838.02** Avorio / Ivory

Cert.di esame CE tipo N.DIP 26897  
Conforme alle normative  
UNI EN 28848 - UNI EN 29775

In conformity with the UNI EN 28848  
UNI EN 29775 - UNI EN ISO 10592 STANDARDS.

# VS12



## DESCRIZIONE / DESCRIPTION

Diametro / Diameter: 350 / 350

Impugnatura / Grip: Poliuretano-Mogano-Inox / Polyurethane-Mahogany-inox

Razze / Spokes: Acciaio inox / Stainless steel

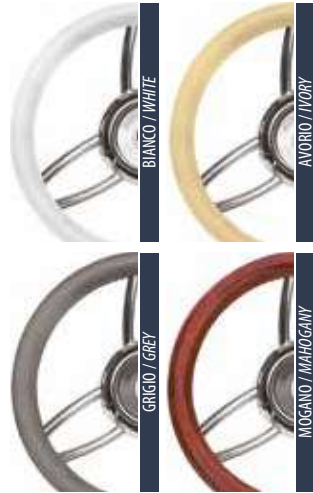
## CODICE ORDINAZIONE / ORDER CODES

- 62.00839.00** Nero / Black
- 62.00839.01** Bianco / White
- 62.00839.02** Avorio / Ivory
- 62.00839.03** Grigio / Grey
- 62.00839.04** Mogano / Mahogany
- 62.00839.05** Inox / Inox

Cert.di esame CE tipo N.DIP 26897  
Conforme alle normative  
UNI EN 28848 - UNI EN 29775

In conformity with the UNI EN 28848  
UNI EN 29775 - UNI EN ISO 10592 STANDARDS.

# VS13



## DESCRIZIONE / DESCRIPTION

Diametro / Diameter: 350 / 350

Impugnatura / Grip: Poliuretano / Polyurethane

Razze / Spokes: Acciaio inox / Stainless steel

## CODICE ORDINAZIONE / ORDER CODES

- 62.00840.00** Nero / Black
- 62.00840.01** Bianco / White
- 62.00840.02** Avorio / Ivory
- 62.00840.03** Grigio / Grey
- 62.00840.04** Mogano / Mahogany

Cert.di esame CE tipo N.DIP 26897  
Conforme alle normative  
UNI EN 28848 - UNI EN 29775

In conformity with the UNI EN 28848  
UNI EN 29775 - UNI EN ISO 10592 STANDARDS.



# Riviera

COMANDI  
*LEVER CONTROL*

---



**LEVER CONTROL**



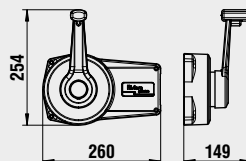
**CM01****CM02****CM01****CARATTERISTICHE/ KEY FEATURES**

Installazione / <i>Installation:</i>	Parete / <i>Wall mount</i>
Sicurezza/ <i>Safety:</i>	Meccanica / <i>Mechanical</i>
Corsa accel. / <i>Accelerator stroke:</i>	88 / 88
Corsa invertitore / <i>Inverter stroke:</i>	68 - 76 / 68 - 76

**CODICI ORDINAZIONE / ORDER CODES**

<b>62.00008.01 CM01</b>	Nera / <i>Black</i>
<b>62.00008.02 CM01</b>	Bianca / <i>White</i>

Compatibili con cavi RIVIERA modello F14/F05 e, con adattatore fornito di serie, con cavi modello F02/F08.  
*For use with riviera F14/F05 cables, for use with riviera F02/F08 cables - the adaptor is included.*



Direzione acceleratore reversibile.  
 Accelerazione in folle per riscaldamento motore.  
 Realizzate in materiali speciali Delrin 100, Eltex e Ixef, resistenti all'usura agenti atmosferici.  
 Parti accessorie in acciaio inossidabile.

*Reversible accelerator direction. Neutral throttle warm-up. Made of wear and atmospheric agents resistant materials. Stainless steel accessory parts.*

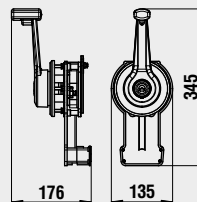
**CM02****CARATTERISTICHE/ KEY FEATURES**

Installazione / <i>Installation:</i>	Incasso / <i>Flush mount</i>
Sicurezza/ <i>Safety:</i>	Meccanica / <i>Mechanical</i>
Corsa accel. / <i>Accelerator stroke:</i>	88 / 88
Corsa invertitore / <i>Inverter stroke:</i>	68 - 76 / 68 - 76

**CODICI ORDINAZIONE / ORDER CODES**

<b>62.00007.01 CM02</b>	Nera / <i>Black</i>
<b>62.00007.02 CM02</b>	Bianca / <i>White</i>

Compatibili con cavi RIVIERA modello F14/F05 e, con adattatore fornito di serie, con cavi modello F02/F08.  
*For use with riviera F14/F05 cables, for use with riviera F02/F08 cables - the adaptor is included.*



Direzione acceleratore reversibile.  
 Accelerazione in folle per riscaldamento motore.  
 Realizzate in materiali speciali Delrin 100, Eltex e Ixef, resistenti all'usura agenti atmosferici.  
 Parti accessorie in acciaio inossidabile.

*Reversible accelerator direction. Neutral throttle warm-up. Made of wear and atmospheric agents resistant materials. Stainless steel accessory parts.*

**ONE LEVER CONTROL**



## CM03



### CM03

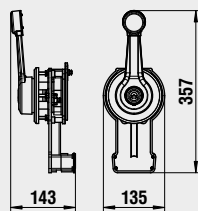
#### CARATTERISTICHE/ KEY FEATURES

Installazione / <i>Installation:</i>	Incasto / <i>Flush mount</i>
Sicurezza/ <i>Safety:</i>	Meccanica / <i>Mechanical</i>
Corsa accel. / <i>Accelerator stroke:</i>	88 / 88
Corsa invertitore / <i>Inverter stroke:</i>	68 - 76 / 68 - 76

#### CODICI ORDINAZIONE / ORDER CODES

**62.00010.01 CM03** Nera / *Black*  
**62.00010.02 CM03** Bianca / *White*

Compatibili con cavi RIVIERA modello F14/F05 e, con adattatore fornito di serie, con cavi modello F02/F08.  
*For use with riviera F14/F05 cables, for use with riviera F02/F08 cables - the adaptor is included.*



Direzione acceleratore reversibile.  
 Accelerazione in folle per riscaldamento motore.  
 Realizzate in materiali speciali Delrin 100, Eltex e Ixef, resistenti all'usura agenti atmosferici.  
 Parti accessorie in acciaio inossidabile.

*Reversible accelerator direction. Neutral throttle warm-up. Made of wear and atmospheric agents resistant materials. Stainless steel accessory parts.*

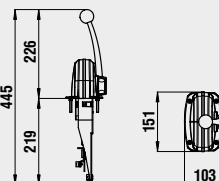


**CM04****CM05****CM04****CARATTERISTICHE/ KEY FEATURES**

Installazione / <i>Installation:</i>	Cruscotto / <i>Top mount</i>
Sicurezza/ <i>Safety:</i>	Elettrica / <i>Electrical</i>
Corsa accel. / <i>Accelerator stroke:</i>	63 / <i>63</i>
Corsa invertitore / <i>Inverter stroke:</i>	68,5 - 75 - 82 / <i>68,5 - 75- 82</i>

**CODICI ORDINAZIONE / ORDER CODES****62.00540.00** Monoleva singola / *One lever*

Compatibili, con adattatore fornito di serie, con cavi modello F02/F08.

*For use with Riviera F02/F08 cables - the adaptor is included.*

Direzione acceleratore reversibile. Accelerazione in folle per riscaldamento motore. Realizzate in zama, ramate e cromate secondo specifiche RIVIERA. Parti accessorie in acciaio inossidabile. Dotate di dispositivo antiavviamento in conformità alla normativa UNI-EN 11547.

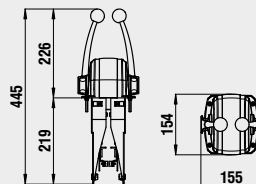
*Reversible accelerator direction. Neutral throttle warm-up. Made of wear and atmospheric agents resistant materials. Stainless steel accessory parts.*

**CM05****CARATTERISTICHE/ KEY FEATURES**

Installazione / <i>Installation:</i>	Cruscotto / <i>Top mount</i>
Sicurezza/ <i>Safety:</i>	Elettrica / <i>Electrical</i>
Corsa accel. / <i>Accelerator stroke:</i>	63 / <i>63</i>
Corsa invertitore / <i>Inverter stroke:</i>	68,5 - 75 - 82 / <i>68,5 - 75- 82</i>

**CODICI ORDINAZIONE / ORDER CODES****62.00541.00** Monoleva doppia / *Two lever*

Compatibili, con adattatore fornito di serie, con cavi modello F02/F08.

*For use with Riviera F02/F08 cables - the adaptor is included.*

Direzione acceleratore reversibile. Accelerazione in folle per riscaldamento motore. Realizzate in zama, ramate e cromate secondo specifiche RIVIERA. Parti accessorie in acciaio inossidabile. Dotate di dispositivo antiavviamento in conformità alla normativa UNI-EN 11547.

*Reversible accelerator direction. Neutral throttle warm-up. Made of wear and atmospheric agents resistant materials. Stainless steel accessory parts.*

**CB01****CB02****INVERTITORE / SHIFT****ACCELERATORE / THROTTLE**SX LEVA SINISTRA / *LEFT LEVER*DX LEVA DESTRA / *RIGHT LEVER*

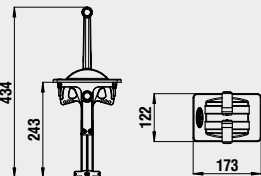
**BLOCCO** fermo meccanico che impedisce l'inserimento della marcia con acceleratore in posizione diversa dal minimo.

*BLOCK* mechanical stop that prevents the insertion of the gear with throttle position other than the minimum

**CB01 Leve diritte / Straigh levels**

Direzione acceleratore reversibile.  
Leve realizzate in zama, ramate e cromate secondo specifiche RIVIERA.  
Parti accessorie in acciaio inossidabile.  
Dotate di dispositivo antiavviamento in conformità alla normativa EN 11547.

*Reversible accelerator direction.  
Made of zamak copper plated and chromium plated according to Riviera specifications.  
Stainless steel accessory parts.  
With anti starting device in conformity with EN 11547 safety standards.*

**CARATTERISTICHE/ KEY FEATURES**

Installazione / <i>Installation:</i>	Incasso / <i>Flush mount</i>
Sicurezza/ <i>Safety:</i>	Secondo modello / <i>The model that need</i>
Corsa accel. / <i>Accelerator stroke:</i>	53 - 66 - 78 / <i>53 - 66 - 78</i>
Corsa invertitore / <i>Inverter stroke:</i>	53 - 66 - 78 / <i>53 - 66 - 78</i>

**Accessori / Accessories****COD. ORDINAZIONE / ORDER COD.**

		<b>60.02676.00</b> Base nera / <i>Black grill</i>
		<b>60.02676.01</b> Base bianca / <i>White grill</i>

**SX DX CODICI ORDINAZIONE / ORDER CODES**

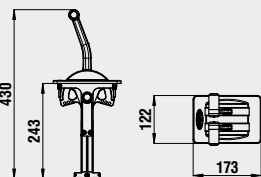
● ●	<b>62.00556.00</b>	Acc/Inv-C/blocco - Base nera / <i>Throttle Shift - safety block - black</i>
● ●	<b>62.00556.01</b>	Acc/Inv-C/blocco - Base bianca / <i>Throttle Shift - safety block - white</i>
● ●	<b>62.00556.20</b>	Inv/Inv - Base nera / <i>Shift/Shift - black</i>
● ●	<b>62.00556.21</b>	Inv/Inv - Base bianca / <i>Shift/Shift - white</i>
● ●	<b>62.00556.30</b>	Acc/Acc - Base nera / <i>Throttle/throttle - black</i>
● ●	<b>62.00556.31</b>	Acc/Acc - Base bianca / <i>Throttle/throttle - white</i>
● ●	<b>62.00556.40</b>	Inv/Acc - C/blocco - Base nera / <i>Shift/throttle - safety block - black</i>
● ●	<b>62.00556.41</b>	Inv/Acc-C/blocco Base bianca / <i>Shift/throttle - safety block - white</i>

Compatibili, con adattatore fornito di serie, con cavi modello F02/F08 / *For use with Riviera F02/F08 cables - the adaptor is included.*

**CB02 Leve inclinate / Bent levels**

Direzione acceleratore reversibile.  
Accelerazione in folle per riscaldamento motore.  
Realizzate in zama, ramate e cromate secondo specifiche RIVIERA.  
Parti accessorie in acciaio inossidabile.  
Dotate di dispositivo antiavviamento in conformità alla normativa EN 11547.

*Reversible accelerator direction.  
Made of zamak copper plated and chromium plated according to Riviera specifications.  
Stainless steel accessory parts.  
With anti starting device in conformity with EN 11547 safety standards.*

**CARATTERISTICHE/ KEY FEATURES**

Installazione / <i>Installation:</i>	Incasso / <i>Flush mount</i>
Sicurezza/ <i>Safety:</i>	Secondo modello / <i>The model that need</i>
Corsa accel. / <i>Accelerator stroke:</i>	53 - 66 - 78 / <i>53 - 66 - 78</i>
Corsa invertitore / <i>Inverter stroke:</i>	53 - 66 - 78 / <i>53 - 66 - 78</i>

**Accessori / Accessories****COD. ORDINAZIONE / ORDER COD.**

		<b>60.02676.00</b> Base nera / <i>Black grill</i>
		<b>60.02676.01</b> Base bianca / <i>White grill</i>

**SX DX CODICI ORDINAZIONE / ORDER CODES**

● ●	<b>62.00545.00</b>	Acc/Inv-C/blocco - Base nera / <i>Throttle Shift - safety block - black</i>
● ●	<b>62.00545.01</b>	Acc/Inv-C/blocco - Base bianca / <i>Throttle Shift - safety block - white</i>
● ●	<b>62.00545.20</b>	Inv/Acc - C/blocco - Base nera / <i>Shift/throttle - safety block - black</i>
● ●	<b>62.00545.21</b>	Inv/Acc-C/blocco Base bianca / <i>Shift/throttle - safety block - white</i>
● ●	<b>62.00545.40</b>	Inv/Inv - Base nera / <i>Shift/Shift - black</i>
● ●	<b>62.00545.41</b>	Inv/Inv - Base bianca / <i>Shift/Shift - white</i>
● ●	<b>62.00545.50</b>	Acc/Acc - Base nera / <i>Throttle/throttle - black</i>
● ●	<b>62.00545.51</b>	Acc/Acc - Base bianca / <i>Throttle/throttle - white</i>

Compatibili, con adattatore fornito di serie, con cavi modello F02/F08 / *For use with Riviera F02/F08 cables - the adaptor is included.*

## CB03



## CB04



■ **INVERTITORE / SHIFT**

■ **ACCELERATORE / THROTTLE**

SX LEVA SINISTRA / *LEFT LEVER*

DX LEVA DESTRA / *RIGHT LEVER*

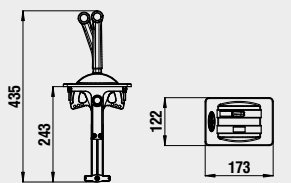
**BLOCCO** fermo meccanico che impedisce l'inserimento della marcia con acceleratore in posizione diversa dal minimo.

*BLOCK* mechanical stop that prevents the insertion of the gear with throttle position other than the minimum

### CB03 Sport - leve combinate / Sport - combined levers

Direzione acceleratore reversibile.  
Leve realizzate in zama, ramate e cromate secondo specifiche RIVIERA.  
Parti accessorie in acciaio inossidabile.  
Dotate di dispositivo antiavviamento in conformità alla normativa EN 11547.

*Reversible accelerator direction.  
Made of zamak copper plated and chromium plated according to Riviera specifications.  
Stainless steel accessory parts.  
With anti starting device in conformity with EN 11547 safety standards.*



#### CARATTERISTICHE/ KEY FEATURES

Installazione / <i>Installation:</i>	Incasso / <i>Flush mount</i>
Sicurezza/ <i>Safety:</i>	Secondo modello / <i>The model that need</i>
Corsa accel. / <i>Accelerator stroke:</i>	53 - 66 - 78 / 53 - 66 - 78
Corsa invertitore / <i>Inverter stroke:</i>	53 - 66 - 78 / 53 - 66 - 78

#### Accessori / Accessories

**COD. ORDINAZIONE / ORDER COD.**



**60.02676.00**

Base nera / *Black grill*

**60.02676.01**

Base bianca / *White grill*

#### SX | DX CODICI ORDINAZIONE / ORDER CODES

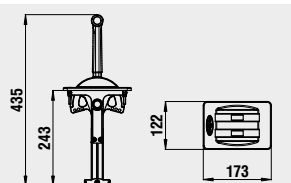
● ●	<b>62.00571.00</b>	Acc/Inv-C/blocco - Base nera / <i>Throttle Shift - safety block - black</i>
● ●	<b>62.00571.01</b>	Acc/Inv-C/blocco - Base bianca / <i>Throttle Shift - safety block - white</i>
● ●	<b>62.00571.20</b>	Inv/Acc - C/blocco - Base nera / <i>Shift/throttle - safety block - black</i>
● ●	<b>62.00571.21</b>	Inv/Acc-C/blocco Base bianca / <i>Shift/throttle - safety block - white</i>
● ●	<b>62.00571.40</b>	Inv/Inv - Base nera / <i>Shift/Shift - black</i>
● ●	<b>62.00571.41</b>	Inv/Inv - Base bianca / <i>Shift/Shift - white</i>
● ●	<b>62.00571.50</b>	Acc/Acc - Base nera / <i>Throttle/throttle - black</i>
● ●	<b>62.00571.51</b>	Acc/Acc - Base bianca / <i>Throttle/throttle - white</i>

Compatibili, con adattatore fornito di serie, con cavi modello F02/F08 / *For use with Riviera F02/F08 cables - the adaptor is included.*

### CB04 Sport - leve diritte / Sport - straight levers

Direzione acceleratore reversibile.  
Leve realizzate in zama, ramate e cromate secondo specifiche RIVIERA.  
Parti accessorie in acciaio inossidabile.  
Dotate di dispositivo antiavviamento in conformità alla normativa EN 11547.

*Reversible accelerator direction.  
Made of zamak copper plated and chromium plated according to Riviera specifications.  
Stainless steel accessory parts.  
With anti starting device in conformity with EN 11547 safety standards.*



#### CARATTERISTICHE/ KEY FEATURES

Installazione / <i>Installation:</i>	Incasso / <i>Flush mount</i>
Sicurezza/ <i>Safety:</i>	Secondo modello / <i>The model that need</i>
Corsa accel. / <i>Accelerator stroke:</i>	53 - 66 - 78 / 53 - 66 - 78
Corsa invertitore / <i>Inverter stroke:</i>	53 - 66 - 78 / 53 - 66 - 78

#### Accessori / Accessories

**COD. ORDINAZIONE / ORDER COD.**



**60.02676.00**

Base nera / *Black grill*

**60.02676.01**

Base bianca / *White grill*

#### SX | DX CODICI ORDINAZIONE / ORDER CODES

● ●	<b>62.00574.00</b>	Inv/Inv - Base nera / <i>Shift/Shift - black</i>
● ●	<b>62.00574.01</b>	Inv/Inv - Base bianca / <i>Shift/Shift - white</i>
● ●	<b>62.00574.10</b>	Acc/Acc - Base nera / <i>Throttle/throttle - black</i>
● ●	<b>62.00574.11</b>	Acc/Acc - Base bianca / <i>Throttle/throttle - white</i>
● ●	<b>62.00574.20</b>	Acc/Inv-C/blocco - Base nera / <i>Throttle Shift - safety block - black</i>
● ●	<b>62.00574.21</b>	Acc/Inv-C/blocco - Base bianca / <i>Throttle Shift - safety block - white</i>
● ●	<b>62.00574.40</b>	Inv/Acc - C/blocco - Base nera / <i>Shift/throttle - safety block - black</i>
● ●	<b>62.00574.41</b>	Inv/Acc-C/blocco Base bianca / <i>Shift/throttle - safety block - white</i>

Compatibili, con adattatore fornito di serie, con cavi modello F02/F08 / *For use with Riviera F02/F08 cables - the adaptor is included.*





## CB05



## CB06



■ INVERTITORE / SHIFT

■ ACCELERATORE / THROTTLE

SX LEVA SINISTRA / LEFT LEVER

DX LEVA DESTRA / RIGHT LEVER

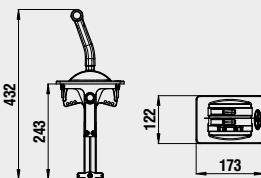
**BLOCCO** fermo meccanico che impedisce l'inserimento della marcia con acceleratore in posizione diversa dal minimo.

*BLOCK* mechanical stop that prevents the insertion of the gear with throttle position other than the minimum

### CB05 Sport - leve inclinate / Sport - bent levers

Direzione acceleratore reversibile.  
Leve realizzate in zama, ramate e cromate secondo specifiche RIVIERA.  
Parti accessorie in acciaio inossidabile.  
Dotate di dispositivo antiavviamento in conformità alla normativa EN 11547.

*Reversible accelerator direction.  
Made of zamak copper plated and chromium plated according to Riviera specifications.  
Stainless steel accessory parts.  
With anti starting device in conformity with EN 11547 safety standards.*



#### CARATTERISTICHE/ KEY FEATURES

Installazione / <i>Installation:</i>	Incasso / <i>Flush mount</i>
Sicurezza/ <i>Safety:</i>	Secondo modello / <i>The model that need</i>
Corsa accel. / <i>Accelerator stroke:</i>	53 - 66 - 78 / <i>53 - 66 - 78</i>
Corsa invertitore / <i>Inverter stroke:</i>	53 - 66 - 78 / <i>53 - 66 - 78</i>

#### Accessori / Accessories

COD. ORDINAZIONE / *ORDER COD.*

	<b>60.02676.00</b> Base nera / <i>Black grill</i>
	<b>60.02676.01</b> Base bianca / <i>White grill</i>

#### SX DX CODICI ORDINAZIONE / ORDER CODES

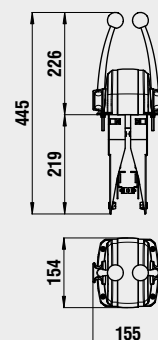
● ●	<b>62.00612.00</b>	Acc/Acc - Base nera / <i>Throttle/throttle - black</i>
● ●	<b>62.00612.01</b>	Acc/Acc - Base bianca / <i>Throttle/throttle - white</i>
● ●	<b>62.00612.10</b>	Inv/Inv - Base nera / <i>Shift/Shift - black</i>
● ●	<b>62.00612.11</b>	Inv/Inv - Base bianca / <i>Shift/Shift - white</i>
● ●	<b>62.00612.20</b>	Inv/Acc - C/blocco - Base nera / <i>Shift/throttle - safety block - black</i>
● ●	<b>62.00612.21</b>	Inv/Acc-C/blocco Base bianca / <i>Shift/throttle - safety block - white</i>
● ●	<b>62.00612.40</b>	Acc/Inv-C/blocco - Base nera / <i>Throttle Shift - safety block - black</i>
● ●	<b>62.00612.41</b>	Acc/Inv-C/blocco - Base bianca / <i>Throttle Shift - safety block - white</i>

Compatibili, con adattatore fornito di serie, con cavi modello F02/F08 / *For use with Riviera F02/F08 cables - the adaptor is included.*

### CB06 Leve cromate / Chromium plated levers

Direzione acceleratore reversibile.  
Accelerazione in folle per riscaldamento motore.  
Realizzate in zama, ramate e cromate secondo specifiche RIVIERA.  
Parti accessorie in acciaio inossidabile.  
Dotate di dispositivo antiavviamento in conformità alla normativa EN 11547.

*Reversible accelerator direction.  
Made of zamak copper plated and chromium plated according to Riviera specifications.  
Stainless steel accessory parts.  
With anti starting device in conformity with EN 11547 safety standards.*



#### CARATTERISTICHE/ KEY FEATURES

Installazione / <i>Installation:</i>	Cruscotto / <i>Top mount</i>
Sicurezza/ <i>Safety:</i>	Secondo modello / <i>The model that need</i>
Corsa accel. / <i>Accelerator stroke:</i>	68,5 - 75 - 82 / <i>68,5 - 75 - 82</i>
Corsa invertitore / <i>Inverter stroke:</i>	68,5 - 75 - 82 / <i>68,5 - 75 - 82</i>

#### SX DX CODICI ORDINAZIONE / ORDER CODES

● ●	<b>62.00599.00</b>	Acc/Inv / <i>Throttle Shift</i>
● ●	<b>62.00599.10</b>	Inv/Acc/ <i>Shift/throttle</i>
● ●	<b>62.00599.20</b>	Inv/Inv / <i>Shift/Shift</i>
● ●	<b>62.00599.30</b>	Acc/Acc / <i>Throttle/throttle</i>

Compatibili, con adattatore fornito di serie, con cavi modello F02/F08 / *For use with Riviera F02/F08 cables - the adaptor is included.*



**Riviera**

**CAVI CONTROLLO MOTORE  
ENGINE CONTROL CABLE**

---



**ENGINE CONTROL CABLE**



## GUIDA ALLA SCELTA DELLA LUNGHEZZA DEI CAVI FLESSIBILI PER L'INSTALLAZIONE

PER LE PRIME INSTALLAZIONI, misurare la distanza A+B dalla scatola di comando all'acceleratore e/o invertitore del motore lungo un percorso libero da ostacoli. La misura ricavata, arrotondata al valore intero superiore, sarà la lunghezza del vostro cavo.

Si raccomanda che le curve compiute dai cavi abbiano un raggio minimo di circa 200 mm (8").

Per ottenere la lunghezza dei cavi in piedi, dividere il risultato ottenuto in cm per 30.5 e arrotondate al piede superiore.

Per installazioni con motori fuoribordo è necessario aggiungere 90 cm (3") alla lunghezza ottenuta, per permettere il movimento del motore.

Per i ricambi è sufficiente misurare il cavo che dovete sostituire da un'estremità all'altra.

Per ordinare specificate la lunghezza del cavo in metri o in piedi, arrotondando ai valori interi superiori.

## HOW TO MEASURE FOR CONTROL CABLE INSTALLATION

*FOR NEW INSTALLATION, measure A + B distance from the control along an unobstructed cable routing to clutch and/or throttle connection.*

*Round this dimension off to the next whole foot: you will have your cable length.*

*We recommend that the cable bends have a minimum radius of about 8" (200 mm).*

*For outboard engine installations, it is necessary to add three feet to the obtained length, in order to allow the engine movement.*

*To determine the needed length of the REPLACEMENT CABLE, measure it from tip to tip.*

*When ordering, specify the cable length in feet, rounding the dimension off to the next whole value. If any kit is required to complete the cable connection, consult the appropriate section in this catalogue.*

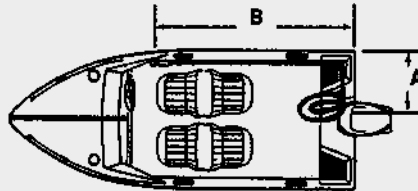


**SERIE ANTEA CEA01 / ANTEA SERIES CEA01**

	<b>MOTORI ENGINE</b>	<b>TRASMISSIONI FLESSIBILI RIVIERA RIVIERA ENGINE CONTROL CABLE</b>
<b>FUORIBORDO OUTBOARD</b>	Mercury Scatole Gen. II	<b>F36 - AS08+KIT</b>
	Mercury Mariner oltre 50 hp (37kW)	<b>F05 F07</b>
	Mariner fino a 50hp (37kW)	<b>F16</b>
	Force Selva Yamaha Suzuki Tohatsu Honda Nissan	<b>F02-F08-AS08</b>
	Johnson Evinrude	dopo il 1979 <b>F14 AS08+KIT - F06</b>
<b>ENTROFUORI BORDO STERNDRIVE</b>	Mer cruiser Scatole Gen.II	<b>F36 - AS08+KIT</b>
	Mer cruiser	<b>F05 - F07</b>
	OMC	dopo il 1979 <b>F14 AS08+KIT - F06</b>
	Volvo Penta Yanmar Volkswagen	<b>F02-F08-AS08</b>
<b>ENTROBORDO FUORIBORDO OUTBOARD INBOARD</b>		<b>F02-F08-AS08</b>

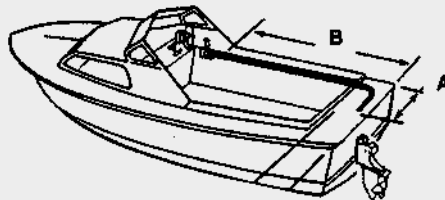
**FUORIBORDO / INBOARD**

$A+B+3' (90 \text{ cm}) = L$



**ENTROBORDO / OUTBOARD  
ENTROFUORIBORDO / STERNDRIVE**

$A+B = L$





## CAVI LOW FRICTION CONTROLLO MOTORE AD ALTA EFFICIENZA E FLESSIBILITÀ

Linea di cavi ad alta efficienza che la **RIVIERA** ha sviluppato per venire incontro alle richieste sempre più crescenti del mercato di cavi "alta scorrevolezza" realizzati in varie configurazioni dei terminali.

## LOW FRICTION ENGINE CONTROL CABLE

High efficiency control cables that **RIVIERA** has developed in order to meet the increasing request for "high performance" cables in various configurations

### CARATTERISTICHE E PRESTAZIONI / FEATURES AND PERFORMANCE

- Adatti a tutti i motori fuoribordo, entro-bordo ed entro-fuoribordo.  
*Suitable for outboard – inboard and sterndrive engines.*
- Alta scorrevolezza  
*High efficiency for smooth operation.*
- Elevata flessibilità che consente ridotti raggi di curvatura, quindi ideale per percorsi particolarmente tortuosi.  
*High flexibility for reduced bend radius. Ideal for long complex cable routings.*
- Non necessita di manutenzione  
*Maintenance free.*
- Terminali in acciaio inox  
*Stainless steel stock.*
- Guaina blu ad alta resistenza all'abrasione, raggi UV e sostanze chimiche.  
*High resistance blue outer sheath against abrasion, UV and chemicals*

### LOW FRICTION (ALTA SCORREVOLEZZA) / LOW FRICTION

- Le alte prestazioni di questi cavi sono frutto della nostra lunga esperienza nella produzione di trasmissioni flessibili: la formazione speciale del cavo interno permette di ottenere risultati di alta efficienza insieme ad un gioco ridotto, mentre il disegno esclusivo della guaina fornisce un alto livello di flessibilità  
*Low friction cables are the result of our decades of experience in producing high quality, long lasting, flexible cables.*  
*The innovative core design maximizes efficiency and minimizes lost motion, while the exclusive design of the conduit provides extremely high level of flexibility.*



**AS08** UNIVERSALE / UNIVERSAL



**AS08 + KIT RI57** Utilizzabile su motori JOHNSON® EVINRUDE® OMC®  
*Suitable for JOHNSON® EVINRUDE® OMC® engine*



**AS08 + KIT RI56** Utilizzabile su motori MERCURY® MERCUISER®  
*Suitable for MERCURY® MERCUISER® engines*



# AS08



## CARATTERISTICHE/ KEY FEATURES

Corsa / Stroke:	87 mm / 87 mm
Diametro guaina / Sheath diameter:	8 mm / 8 mm
Compatibilità / Suitable for:	Universale / Universal

## CODICI ORDINAZIONE / ORDER CODES

**62.00755.00**

Indicare, al posto delle ultime due cifre, la lunghezza in piedi desiderata  
*To order the right cable replace the last two number (00) with the feet length required.*

PIEDI <i>FEET</i>	METRI <i>METER</i>	PIEDI <i>FEET</i>	METRI <i>METER</i>	PIEDI <i>FEET</i>	METRI <i>METER</i>
05	1,5240	17	5,1816	29	8,8392
06	1,8288	18	5,4864	30	9,1440
07	2,1346	19	5,7912	31	9,4488
08	2,4384	20	6,0960	32	9,7536
09	2,7432	21	6,4008	33	10,0584
10	3,0480	22	6,7056	34	10,3632
11	3,3528	23	7,0104	35	10,6680
12	3,6576	24	7,3152	36	10,9728
13	3,9624	25	7,6200	37	11,2776
14	4,2672	26	7,9248	38	11,5824
15	4,5720	27	8,2296	39	11,8872
16	4,8768	28	8,5344	40	12,1920

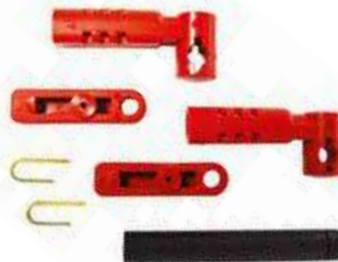
Cavo comando tiro/spinta adatto per installazioni su motori entrobordo, entrofuoribordo e fuoribordo in cui si richiede un'alta efficienza ed elevata flessibilità o con percorsi difficili.  
 Guaina blu.

*Pull/Push control cable use with inboard, sterndrive and outboard engines. Ideal for high performance applications. Blue color Sheath.*

## KIT RI56 KIT di adattamento Cavo F02 F08 AS08 ai motori Mercury Adaptor KIT for Cable F02 F08 AS08 on Mercury engines

### CODICI ORDINAZIONE / ORDER CODES

**62.00764.00**



## KIT RI57 KIT di adattamento Cavo F02 F08 AS08 ai motori Johnson Evinrude Adaptor KIT for Cable F02 F08 AS08 on Johnson Evinrude engines

### CODICI ORDINAZIONE / ORDER CODES

**62.00765.00**



155 ENGINE CONTROL CABLE - LOW FRICTION



## CAVI FLESSIBILI PER IL CONTROLLO DEL MOTORE

### CARATTERISTICHE E PRESTAZIONI / FEATURES AND PERFORMANCE

Disponibili nelle seguenti configurazioni dei terminali / Available in the following configurations

**F02** Tipo Universale / *Universal type*

**F08** Tipo Universale / *Universal type*

**F14** Tipo OMC, Johnson, Evinrude / *OMC, Johnson, Evinrude type*

**F06** Tipo OMC, Johnson, Evinrude / *OMC, Johnson, Evinrude type*

**F07** Mercury, Mercruiser / *Mercury, Mercruiser type*

**F36** Tipo Mercury, Mercruiser, Mariner / *Mercury, Mercruiser, Mariner type*

**F05** Tipo Mercury, Mercruiser, Mariner / *Mercury, Mercruiser, Mariner type*

**F16** Tipo Mercury, Mercruiser, Mariner / *Mercury, Mercruiser, Mariner type*

- Adatti a tutti i motori fuoribordo, entro-bordo ed entro-fuoribordo.  
*Suitable for outboard – inboard and sterndrive engines.*
- Non necessita di manutenzione.  
*Maintenance free.*
- Terminali in acciaio inox.  
*Stainless steel stock.*
- Guaina nera ad alta resistenza all'abrasione, raggi UV e sostanze chimiche.  
*High resistance black outer sheath against abrasion, UV and chemicals.*

### CAVI UNIVERSALI / UNIVERSAL CABLES



### CAVI OMC® - JOHNSON® - EVINRUDE® / OMC® - JOHNSON® - EVINRUDE® CABLES



### CAVO STOP / STOP CABLE



### CAVI MERCURY® - MERCUISER® - MARINER® / MERCURY® - MERCUISER® - MARINER®



# F02 CAVI UNIVERSALI UNIVERSAL CABLES



Terminali in acciaio inox.  
Parti metalliche in ottone trattato.  
Anima in acciaio inox da 2 mm.  
Terminale filettato 10-32 UNF.

Push/Pull control cable suitable for all steering systems helm. Stainless steel stock. Treated brass metallic parts. 2 mm stainless steel cup plug. Threaded terminal 10-32 UNF.

## CARATTERISTICHE/ KEY FEATURES

**Corsa / Stroke:** 88 mm / 88 mm

**Diametro guaina / Sheath diameter:** 7 mm / 7 mm

**Compatibilità / Suitable for:** Adatto a tutti i motori entroborordo, entrofuoribordo e fuoribordo mediante gli appositi accessori  
*For use with inboard, sterndrive and outboard engines, with appropriate accessories.*

## CODICI ORDINAZIONE / ORDER CODES

### 62.00000.00

Indicare, al posto delle ultime due cifre, la lunghezza in piedi desiderata  
*To order the right cable replace the last two number (00) with the feet length required.*

PIEDI FEET	METRI METER	PIEDI FEET	METRI METER	PIEDI FEET	METRI METER	PIEDI FEET	METRI METER
05	1,5240	14	4,2672	23	7,0104	32	9,7536
06	1,8288	15	4,5720	24	7,3152	33	10,0584
07	2,1346	16	4,8768	25	7,6200	34	10,3632
08	2,4384	17	5,1816	26	7,9248	35	10,6680
09	2,7432	18	5,4864	27	8,2296	36	10,9728
10	3,0480	19	5,7912	28	8,5344	37	11,2776
11	3,3528	20	6,0960	29	8,8392	38	11,5824
12	3,6576	21	6,4008	30	9,1440	39	11,8872
13	3,9624	22	6,7056	31	9,4488	40	12,1920

# F08 CAVI UNIVERSALI UNIVERSAL CABLES



Terminali in acciaio inox.  
Parti metalliche in ottone trattato.  
Anima in acciaio inox da 2 mm.  
Terminale filettato 10-32 UNF.  
Indicato per lunghezze elevate.

Push/Pull control cable suitable for all steering systems helm. Stainless steel stock. Treated brass metallic parts. 2 mm stainless steel cup plug. Threaded terminal 10-32 UNF

## CARATTERISTICHE/ KEY FEATURES

**Corsa / Stroke:** 88 mm / 88 mm

**Diametro guaina / Sheath diameter:** 8 mm / 8 mm

**Compatibilità / Suitable for:** Adatto a tutti i motori entroborordo, entrofuoribordo e fuoribordo mediante gli appositi accessori  
*For use with inboard, sterndrive and outboard engines, with appropriate accessories.*

## CODICI ORDINAZIONE / ORDER CODES

### 62.00001.00

Indicare, al posto delle ultime due cifre, la lunghezza in piedi desiderata  
*To order the right cable replace the last two number (00) with the feet length required.*

PIEDI FEET	METRI METER	PIEDI FEET	METRI METER	PIEDI FEET	METRI METER	PIEDI FEET	METRI METER
05	1,5240	14	4,2672	23	7,0104	32	9,7536
06	1,8288	15	4,5720	24	7,3152	33	10,0584
07	2,1346	16	4,8768	25	7,6200	34	10,3632
08	2,4384	17	5,1816	26	7,9248	35	10,6680
09	2,7432	18	5,4864	27	8,2296	36	10,9728
10	3,0480	19	5,7912	28	8,5344	37	11,2776
11	3,3528	20	6,0960	29	8,8392	38	11,5824
12	3,6576	21	6,4008	30	9,1440	39	11,8872
13	3,9624	22	6,7056	31	9,4488	40	12,1920



# F14 CAVI OMC® - JOHNSON® - EVINRUDE® OMC® - JOHNSON® - EVINRUDE® CABLES



Cavo di comando tiro/spinta adatto ai motori Johnson, Evinrude e OMC di costruzione successiva al 1979. Terminale in acciaio inox. Parti metalliche in ottone trattato. Anima in acciaio inox da 2 mm.

Push/Pull control cable suitable for Johnson, Evinrude engines and OMC engines manufactured from 1979 to date. Stainless steel stock. Treated brass metallic parts. 2 mm stainless steel cup plug.

## CARATTERISTICHE/ KEY FEATURES

Corsa / Stroke: 75 mm / 75 mm

Diametro guaina / Sheath diameter: 7 mm / 7 mm

Compatibilità / Suitable for: Utilizzabile su motori Johnson®, Evinrude®, OMC costruiti dal 1979 ad oggi.

For use with inboard, sterndrive and outboard engines, OMC® costruiti dal 1979 ad oggi.

## CODICI ORDINAZIONE / ORDER CODES

**62.0004.00**

Indicare, al posto delle ultime due cifre, la lunghezza in piedi desiderata

To order the right cable replace the last two number (00) with the feet length required.

PIEDI FEET	METRI METER	PIEDI FEET	METRI METER	PIEDI FEET	METRI METER	PIEDI FEET	METRI METER	PIEDI FEET	METRI METER
05	1,5240	13	3,9624	20	6,0960	27	8,2296	34	10,3632
06	1,8288	14	4,2672	21	6,4008	28	8,5344	35	10,6680
07	2,1346	15	4,5720	22	6,7056	29	8,8392	36	10,9728
08	2,4384	16	4,8768	23	7,0104	30	9,1440	37	11,2776
09	2,7432	17	5,1816	24	7,3152	31	9,4488	38	11,5824
10	3,0480	18	5,4864	25	7,6200	32	9,7536	39	11,8872
11	3,3528	19	5,7912	26	7,9248	33	10,0584	40	12,1920
12	3,6576								

# F06 CAVI OMC® - JOHNSON® - EVINRUDE® OMC® - JOHNSON® - EVINRUDE® CABLES



Cavo di comando tiro/spinta adatto ai motori Johnson, Evinrude e OMC di costruzione successiva al 1979. Terminale in acciaio inox. Parti metalliche in ottone trattato. Anima in acciaio inox da 2 mm. Terminale filettato 10-32 UNF.

Push/Pull control cable suitable for Johnson, Evinrude engines and OMC engines manufactured from 1979 to date. Stainless steel stock. Treated brass metallic parts. 2 mm stainless steel cup plug. Threaded terminal 10-32 UNF.

## CARATTERISTICHE/ KEY FEATURES

Corsa / Stroke: 75 mm / 75 mm

Diametro guaina / Sheath diameter: 7 mm / 7 mm

Compatibilità / Suitable for: Utilizzabile su motori Johnson®, Evinrude®, OMC costruiti dal 1979 ad oggi.

For use with inboard, sterndrive and outboard engines, OMC® costruiti dal 1979 ad oggi.

## CODICI ORDINAZIONE / ORDER CODES

**62.00421.00**

Indicare, al posto delle ultime due cifre, la lunghezza in piedi desiderata

To order the right cable replace the last two number (00) with the feet length required.

PIEDI FEET	METRI METER	PIEDI FEET	METRI METER	PIEDI FEET	METRI METER	PIEDI FEET	METRI METER	PIEDI FEET	METRI METER
05	1,5240	13	3,9624	20	6,0960	27	8,2296	34	10,3632
06	1,8288	14	4,2672	21	6,4008	28	8,5344	35	10,6680
07	2,1346	15	4,5720	22	6,7056	29	8,8392	36	10,9728
08	2,4384	16	4,8768	23	7,0104	30	9,1440	37	11,2776
09	2,7432	17	5,1816	24	7,3152	31	9,4488	38	11,5824
10	3,0480	18	5,4864	25	7,6200	32	9,7536	39	11,8872
11	3,3528	19	5,7912	26	7,9248	33	10,0584	40	12,1920
12	3,6576								

# F14 CAVI OMC® - JOHNSON® - EVINRUDE® (SPECIFICO PER MOTORI COMANDO A BARRA) OMC® - JOHNSON® - EVINRUDE® CABLES (SPECIFIC FOR BAR CONTROL ENGINE)



Cavo di comando tiro/spinta adatto ai motori Johnson, Evinrude.  
Terminale in acciaio inox.  
Parti metalliche in ottone trattato.  
Anima in acciaio inox da 2 mm.

Push/Pull control cable suitable for Johnson, Evinrude engines and OMC.  
Stainless steel stock.  
Treated brass metallic parts.  
2 mm stainless steel cup plug.

## CARATTERISTICHE/ KEY FEATURES

Corsa / Stroke:	75 mm / 75 mm
Diametro guaina / Sheath diameter:	7 mm / 7 mm
Compatibilità / Suitable for:	Utilizzabile su motori Johnson®, Evinrude®. For Johnson®, Evinrude

## CODICI ORDINAZIONE / ORDER CODES

**62.00004.03** lunghezza determinata per motori con comando a barra  
Length determined for engines with control bar

PIEDI FEET	METRI METER
03	09140

Specifico per motori Johnson - Evinrude con comando a barra

Suitable for Johnson - Evinrude engines with control bar

# S14 CAVO STOP STOP CABLE



Progettato per l'arresto dei motori entrobordo, può essere utilizzato anche per altre applicazioni (es. starter).

Designed for throttle fuel shut-off and other applications.

## CARATTERISTICHE/ KEY FEATURES

Corsa / Stroke:	70 mm / 70 mm
Diametro guaina / Sheath diameter:	7 mm / 7 mm

## CODICI ORDINAZIONE / ORDER CODES

**62.00003.00** Indicare, al posto delle ultime due cifre, la lunghezza in piedi desiderata  
To order the right cable replace the last two number (00) with the feet length required.

PIEDI FEET	METRI METER	PIEDI FEET	METRI METER	PIEDI FEET	METRI METER	PIEDI FEET	METRI METER
05	1,5240	14	4,2672	23	7,0104	32	9,7536
06	1,8288	15	4,5720	24	7,3152	33	10,0584
07	2,1346	16	4,8768	25	7,6200	34	10,3632
08	2,4384	17	5,1816	26	7,9248	35	10,6680
09	2,7432	18	5,4864	27	8,2296	36	10,9728
10	3,0480	19	5,7912	28	8,5344	37	11,2776
11	3,3528	20	6,0960	29	8,8392	38	11,5824
12	3,6576	21	6,4008	30	9,1440	39	11,8872
13	3,9624	22	6,7056	31	9,4488	40	12,1920





## F07 CAVI MERCURY® - MERCUISER® - MARINER® MERCURY® - MERCUISER® - MARINER® CABLES



Cavo di comando tiro/spinta adatto ai motori Mercury e Mercruiser.  
Terminale in acciaio inox.  
Parti metalliche in ottone trattato.  
Anima in acciaio inox da 2 mm.  
Terminale filettato 10-32 UNF.

Push/Pull control cable suitable for Mercury and Mercruiser engines.  
Stainless steel stok.  
Treated brass metallic parts.  
2 mm stainless steel cup plug.  
Threaded terminal 10-32 UNF.

### CARATTERISTICHE/ KEY FEATURES

Corsa / Stroke:	75 mm / 75 mm
Diametro guaina / Sheath diameter:	7 mm / 7 mm
Compatibilità / Suitable for:	Utilizzabile su motori Mercury®, Mercruiser® For Mercury®, Mercruiser® engines.

### CODICI ORDINAZIONE / ORDER CODES

**62.00431.00**

Indicare, al posto delle ultime due cifre, la lunghezza in piedi desiderata  
To order the right cable replace the last two number (00) with the feet length required.

PIEDI FEET	METRI METER	PIEDI FEET	METRI METER	PIEDI FEET	METRI METER	PIEDI FEET	METRI METER	PIEDI FEET	METRI METER
05	1,5240	13	3,9624	20	6,0960	27	8,2296	34	10,3632
06	1,8288	14	4,2672	21	6,4008	28	8,5344	35	10,6680
07	2,1346	15	4,5720	22	6,7056	29	8,8392	36	10,9728
08	2,4384	16	4,8768	23	7,0104	30	9,1440	37	11,2776
09	2,7432	17	5,1816	24	7,3152	31	9,4488	38	11,5824
10	3,0480	18	5,4864	25	7,6200	32	9,7536	39	11,8872
11	3,3528	19	5,7912	26	7,9248	33	10,0584	40	12,1920
12	3,6576								

## F36 CAVI MERCURY® - MERCUISER® - MARINER® MERCURY® - MERCUISER® - MARINER® CABLES



Cavo di comando tiro/spinta adatto ai motori Mercury e Mercruiser.  
Terminale in acciaio inox.  
Parti metalliche in ottone trattato.  
Anima in acciaio inox da 2 mm.

Push/Pull control cable for Mercury® and Mercruiser® engines and Mercury® Generation II™ series controls.  
Stainless steel stok.  
Treated brass metallic parts.  
2 mm stainless steel cup plug.

### CARATTERISTICHE/ KEY FEATURES

Corsa / Stroke:	85 mm / 85 mm
Diametro guaina / Sheath diameter:	7 mm / 7 mm
Compatibilità / Suitable for:	Utilizzabile su motori Mercury® e Mercruiser® e scatole di comando Mercury® serie Generation II™ For Mercury® and Mercruiser® engines and Mercury® Generation II™ series controls.

### CODICI ORDINAZIONE / ORDER CODES

**62.00759.00**

Indicare, al posto delle ultime due cifre, la lunghezza in piedi desiderata  
To order the right cable replace the last two number (00) with the feet length required.

PIEDI FEET	METRI METER	PIEDI FEET	METRI METER	PIEDI FEET	METRI METER	PIEDI FEET	METRI METER	PIEDI FEET	METRI METER
05	1,5240	13	3,9624	20	6,0960	27	8,2296	34	10,3632
06	1,8288	14	4,2672	21	6,4008	28	8,5344	35	10,6680
07	2,1346	15	4,5720	22	6,7056	29	8,8392	36	10,9728
08	2,4384	16	4,8768	23	7,0104	30	9,1440	37	11,2776
09	2,7432	17	5,1816	24	7,3152	31	9,4488	38	11,5824
10	3,0480	18	5,4864	25	7,6200	32	9,7536	39	11,8872
11	3,3528	19	5,7912	26	7,9248	33	10,0584	40	12,1920
12	3,6576								

# F05 CAVI MERCURY® - MERCUISER® MERCURY® - MERCUISER® CABLES



Cavo di comando tiro/spinta adatto ai motori Mercury e Mercruiser.  
Terminale in acciaio inox.  
Parti metalliche in ottone trattato.  
Anima in acciaio inox da 2 mm.

Push/Pull control cable suitable for Mercury and Mercruiser engines.  
Stainless steel stok.  
Treated brass metallic parts.  
2 mm stainless steel cup plug.

## CARATTERISTICHE/ KEY FEATURES

<b>Corsa / Stroke:</b>	95 mm / 95 mm
<b>Diametro guaina / Sheath diameter:</b>	7 mm / 7 mm
<b>Compatibilità / Suitable for:</b>	Utilizzabile su motori Mercury® e Mercruiser® e scatole di comando Mercury® serie Generation II™ <i>For Mercury® and Mercruiser® engines and Mercury® Generation II™ series controls.</i>

## CODICI ORDINAZIONE / ORDER CODES

### 62.00002.00

lunghezza determinata per motori con comando a barra  
*Length determined for engines with control bar*

PIEDI <i>FEET</i>	METRI <i>METER</i>	PIEDI <i>FEET</i>	METRI <i>METER</i>	PIEDI <i>FEET</i>	METRI <i>METER</i>	PIEDI <i>FEET</i>	METRI <i>METER</i>
05	1,5240	13	3,9624	20	6,0960	27	8,2296
06	1,8288	14	4,2672	21	6,4008	28	8,5344
07	2,1346	15	4,5720	22	6,7056	29	8,8392
08	2,4384	16	4,8768	23	7,0104	30	9,1440
09	2,7432	17	5,1816	24	7,3152	31	9,4488
10	3,0480	18	5,4864	25	7,6200	32	9,7536
11	3,3528	19	5,7912	26	7,9248	33	10,0584
12	3,6576						

# F16 CAVI MARINER® MARINER® CABLES



Cavo di comando tiro/spinta adatto ai motori Mariner.  
Terminale in acciaio inox.  
Parti metalliche in ottone trattato.  
Anima in acciaio inox da 2 mm.

Push/Pull control cable suitable for Mariner engines.  
Stainless steel stok.  
Treated brass metallic parts.  
2 mm stainless steel cup plug.

## CARATTERISTICHE/ KEY FEATURES

<b>Corsa / Stroke:</b>	80 mm / 80 mm
<b>Diametro guaina / Sheath diameter:</b>	7 mm / 7 mm
<b>Compatibilità / Suitable for:</b>	Utilizzabile su motori Mariner® con potenza fino a 40 HP <i>For Mariner® engines up to 40 HP</i>

## CODICI ORDINAZIONE / ORDER CODES

### 62.00760.00

Indicare, al posto delle ultime due cifre, la lunghezza in piedi desiderata  
*To order the right cable replace the last two number (00) with the feet length required.*

PIEDI <i>FEET</i>	METRI <i>METER</i>	PIEDI <i>FEET</i>	METRI <i>METER</i>	PIEDI <i>FEET</i>	METRI <i>METER</i>	PIEDI <i>FEET</i>	METRI <i>METER</i>
05	1,5240	13	3,9624	20	6,0960	27	8,2296
06	1,8288	14	4,2672	21	6,4008	28	8,5344
07	2,1346	15	4,5720	22	6,7056	29	8,8392
08	2,4384	16	4,8768	23	7,0104	30	9,1440
09	2,7432	17	5,1816	24	7,3152	31	9,4488
10	3,0480	18	5,4864	25	7,6200	32	9,7536
11	3,3528	19	5,7912	26	7,9248	33	10,0584
12	3,6576						

**DESCRIZIONE / DESCRIPTION**

Fermafilo con vite e copiglia  
*Wire-stop with screw and cotter pin*



prezzo a conf. 10 PZ.  
*price per 10 pieces package*

**COD.ORDINAZIONE / ORDER COD.**  
**62.00369.00**

**DESCRIZIONE / DESCRIPTION**

Staffa per bloccocavo  
*Cable stop clamp*



prezzo a conf. 5 PZ.  
*price per 5 pieces package*

**COD.ORDINAZIONE / ORDER COD.**  
**62.00513.00**

**DESCRIZIONE / DESCRIPTION**

Terminale per F02/F08  
*Cable head for F02/F08*



prezzo a conf. 10 PZ.  
*price per 10 pieces package*

**COD.ORDINAZIONE / ORDER COD.**  
**62.00466.00**

**DESCRIZIONE / DESCRIPTION**

Fermafilo per F02-F08  
*Wire stop for F02/F08 cables*



prezzo a conf. 10 PZ.  
*price per 10 pieces package*

**COD.ORDINAZIONE / ORDER COD.**  
**62.00529.00**

**DESCRIZIONE / DESCRIPTION**

Fermacavi  
*Stop cables*



prezzo a conf. 10 PZ.  
*price per 10 pieces package*

**COD.ORDINAZIONE / ORDER COD.**  
**62.00514.00**

**DESCRIZIONE / DESCRIPTION**

Snodo filettato per cavi F02-F08  
*Ball threaded for F02/F08 cables*



prezzo a conf. 5 PZ.  
*price per 5 pieces package*

**COD.ORDINAZIONE / ORDER COD.**  
**62.00550.00**

**DESCRIZIONE / DESCRIPTION**

Adattatore per montaggio  
 cavo universale su  
 monoleve Riviera  
*Universal cable assembly  
 adapter for Riviera single  
 levers*



**COD.ORDINAZIONE / ORDER COD.**  
**62.00364.00**

**DESCRIZIONE / DESCRIPTION**

Staffetta bloccaggio cavi  
 inox 316  
*Cable stop clamp 316  
 stainless steel*



prezzo a conf. 10 PZ.  
*price per 10 pieces package*

**COD.ORDINAZIONE / ORDER COD.**  
**62.00616.10** 12x2,5x3,7mm  
**62.00370.00** 12x2,1x3,2mm

**DESCRIZIONE / DESCRIPTION**

Forcella filettata per cavi F02-F08  
*Clevis for F02/F08 cables*



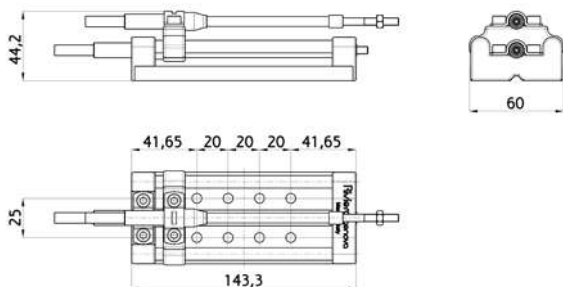
prezzo a conf. 5 PZ.  
*price per 5 pieces package*

**COD.ORDINAZIONE / ORDER COD.**  
**62.00546.00**



### DESCRIZIONE / DESCRIPTION

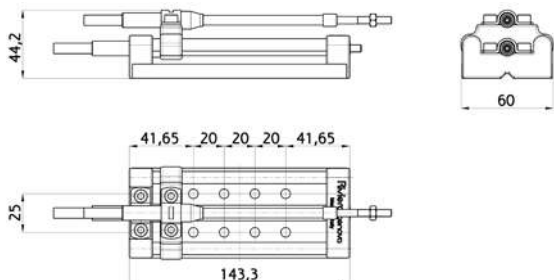
Selettore per invertitore e acceleratore per cavo F02 - F08  
*Inverter and accelerator selector for F02/F08 cables*



**COD.ORDINAZIONE / ORDER COD.**  
**62.00542.00**

### DESCRIZIONE / DESCRIPTION

Selettore per STOP per cavo S14  
*Stop selector for F14 cable*



**COD.ORDINAZIONE / ORDER COD.**  
**62.00552.00**



**DESCRIZIONE / DESCRIPTION**

Sicurezza motori TOHATSU  
TOHATSU Engines safety



**COD.ORDINAZIONE / ORDER COD.**

**62.00564.00** prezzo a conf. 10 PZ.  
price per 10 pieces package

**62.00557.00** Con laccio e moschettone  
With lace and spring catch

**DESCRIZIONE / DESCRIPTION**

Sicurezza motori  
OMC - JOHNSON - EVINRUDE  
OMC-JOHNSON-EVINRUDE  
Engines safety



**COD.ORDINAZIONE / ORDER COD.**

**62.00565.00** prezzo a conf. 10 PZ.  
price per 10 pieces package

**62.00558.00** Con laccio e moschettone  
With lace and spring catch

**DESCRIZIONE / DESCRIPTION**

Sicurezza motori OMC  
OMC Engines safety



**COD.ORDINAZIONE / ORDER COD.**

**62.00566.00** prezzo a conf. 10 PZ.  
price per 10 pieces package

**62.00559.00** Con laccio e moschettone  
With lace and spring catch

**DESCRIZIONE / DESCRIPTION**

Sicurezza motori  
OMC - HONDA  
OMC-HONDA  
Engines safety



**COD.ORDINAZIONE / ORDER COD.**

**62.00567.00** prezzo a conf. 10 PZ.  
price per 10 pieces package

**62.00560.00** Con laccio e moschettone  
With lace and spring catch

**DESCRIZIONE / DESCRIPTION**

Sicurezza motori YAMAHA  
YAMAHA Engines safety



**COD.ORDINAZIONE / ORDER COD.**

**62.00568.00** prezzo a conf. 10 PZ.  
price per 10 pieces package

**62.00561.00** Con laccio e moschettone  
With lace and spring catch

**DESCRIZIONE / DESCRIPTION**

Sicurezza motori  
MARINER - SUZUKI  
MARINER-SUZUKI  
Engines safety



**COD.ORDINAZIONE / ORDER COD.**

**62.00569.00** prezzo a conf. 10 PZ.  
price per 10 pieces package

**62.00562.00** Con laccio e moschettone  
With lace and spring catch

**DESCRIZIONE / DESCRIPTION**

Sicurezza motori  
MARINER - MERCURY  
MARINER-MERCURY  
Engines safety



**COD.ORDINAZIONE / ORDER COD.**

**62.00570.00** prezzo a conf. 10 PZ.  
price per 10 pieces package

**62.00563.00** Con laccio e moschettone  
With lace and spring catch

**DESCRIZIONE / DESCRIPTION**

Moschettone  
Spring catch



**COD.ORDINAZIONE / ORDER COD.**

**62.00632.00** prezzo a conf. 10 PZ.  
price per 10 pieces package

**DESCRIZIONE / DESCRIPTION**

KIT chiavette di sicurezza  
per motori fuoribordo  
Safety keys kit  
for outboard engines

**COD.ORDINAZIONE / ORDER COD.**

**62.00864.00** Con laccio e moschettone 7 chiavette  
Security Stop 7 Keys with Coiled String





## POMPETTE ADESCAMENTO / HAND PRIMER

Realizzate in materiale plastico di elevata qualità.  
Elevato grado di elasticità. Temperatura di esercizio da -30 a +60 °C  
*High quality plastic material*  
*Operating temperature range: -30°C to +60°C*



### COD.ORDINAZIONE / ORDER COD.

- 62.00450.00** Pompetta per tubo Ø 8 / *Hand primer for hose Ø 8*
- 62.00452.00** Pompetta per tubo Ø 8 + 2 m tubo / *Hand primer for hose Ø 8 + 2 m length hose*
- 62.00453.00** Pompetta per tubo Ø 8 + 3 m tubo / *Hand primer for hose Ø 8 + 3 m length hose*
- 62.00450.10** Pompetta per tubo Ø 8 in blister / *Hand primer for hose Ø 8 - blister*
- 62.00451.00** Pompetta per tubo Ø 9,5 / *Hand primer for hose Ø 9,5*
- 62.00454.00** Pompetta per tubo Ø 9,5 + 2 m tubo / *Hand primer for hose Ø 9,5 + 2 m length hose*
- 62.00455.00** Pompetta per tubo Ø 9,5 + 3 m tubo / *Hand primer for hose Ø 9,5 + 3 m length hose*
- 62.00451.10** Pompetta per tubo Ø 9,5 in blister / *Hand primer for hose Ø 9,5 - blister*

## TUBO CARBURANTE / FUEL HOSE

### DESCRIZIONE / DESCRIPTION

Bobina da 50 m. Tubo carburante d.8  
*50 m length. Fuel hose diam.8*



### COD.ORDINAZIONE / ORDER COD.

**62.00725.00**

### DESCRIZIONE / DESCRIPTION

Tubo carburante certificato ISO 8469 B1  
*Fuel hose ISO 8469 B1*

### COD.ORDINAZIONE / ORDER COD.

- 62.00456.00** Ø 8 50m
- 62.00456.25** Ø 8 25m
- 62.00457.00** Ø 9,5 50m
- 62.00457.25** Ø 9,5 25m

Il tubo rispetta i requisiti della norma UNI EN ISO 8469 con resistenza superiore a 1.0 Mpa e mantenimento in soluzione di benzina RP e toluene RPE 55° - 85°.

*The fuel hose has made following the classic requirements of the normative UNI EN ISO 8469 whit resistance bigger than 1.0 Mp and maintenance in petrol solution RP and toluene RPE 55° - 85°*





## JOHNSON EVINRUDE



Connettore maschio  
Filetto in plastica  
Lato serbatoio

*Male connection  
Plastic thread  
Tank side*

**COD.ORDINAZIONE / ORDER COD. 62.00416.00**  
Quantità minima 5 Pz / *minimum quantity 5 pieces*



Connettore maschio  
Filetto in metallo  
Lato serbatoio

*Male connection  
Metallic thread  
Tank side*

**COD.ORDINAZIONE / ORDER COD. 62.00416.01**  
Quantità minima 5 Pz / *minimum quantity 5 pieces*



Connettore maschio  
Innesto per tubo

*Male connection  
Hose clutch*

**COD.ORDINAZIONE / ORDER COD. 62.00417.00**  
Quantità minima 5 Pz / *minimum quantity 5 pieces*



Connettore femmina  
Innesto per tubo

*Female connection  
Hose clutch*

**COD.ORDINAZIONE / ORDER COD. 62.00415.00**  
Quantità minima 5 Pz / *minimum quantity 5 pieces*

## YAMAHA MERCURY MARINER



Connettore maschio corto  
Filetto in plastica

*Male connection  
Plastic thread*

**COD.ORDINAZIONE / ORDER COD. 62.00410.00**  
Quantità minima 5 Pz / *minimum quantity 5 pieces*



Connettore maschio corto  
Innesto per tubo

*Male connection  
Hose clutch*

**COD.ORDINAZIONE / ORDER COD. 62.00411.00**  
Quantità minima 5 Pz / *minimum quantity 5 pieces*



Connettore femmina  
Innesto per tubo

*Female connection  
Hose clutch*

**COD.ORDINAZIONE / ORDER COD. 62.00409.00**  
Quantità minima 5 Pz / *minimum quantity 5 pieces*

## MERCURY MARINER



Connettore maschio  
Filetto in plastica  
Lato serbatoio

*Male connection  
Plastic thread  
Tank side*

**COD.ORDINAZIONE / ORDER COD. 62.00413.00**  
Quantità minima 5 Pz / *minimum quantity 5 pieces*



Connettore maschio  
Filetto in metallo  
Lato serbatoio

*Male connection  
Metallic thread  
Tank side*

**COD.ORDINAZIONE / ORDER COD. 62.00413.01**  
Quantità minima 5 Pz / *minimum quantity 5 pieces*



Connettore maschio  
Innesto per tubo

*Male connection  
Hose clutch*

**COD.ORDINAZIONE / ORDER COD. 62.00414.00**  
Quantità minima 5 Pz / *minimum quantity 5 pieces*



Connettore femmina  
Lato serbatoio

*Female connection  
Tank side*

**COD.ORDINAZIONE / ORDER COD. 62.00412.00**  
Quantità minima 5 Pz / *minimum quantity 5 pieces*

## SELVA - TOHATSU NISSAN



Connettore maschio  
Innesto per tubo

*Male connection  
Hose clutch*

**COD.ORDINAZIONE / ORDER COD. 62.00496.00**  
Quantità minima 5 Pz / *minimum quantity 5 pieces*



Connettore femmina

*Female connection*

**COD.ORDINAZIONE / ORDER COD. 62.00495.00**  
Quantità minima 5 Pz / *minimum quantity 5 pieces*

## HONDA



Connettore maschio  
Filetto in plastica  
Lato motore

*Male connection  
Metallic thread  
Engine side*

**COD.ORDINAZIONE / ORDER COD. 62.00483.00**  
Quantità minima 5 Pz / *minimum quantity 5 pieces*



Connettore femmina  
Lato serbatoio

*Female connection  
Tank side*

**COD.ORDINAZIONE / ORDER COD. 62.00482.00**  
Quantità minima 5 Pz / *minimum quantity 5 pieces*



Connettore femmina  
innesto per tubo

*Female connection  
Hose clutch*

**COD.ORDINAZIONE / ORDER COD. 62.00486.00**  
Quantità minima 5 Pz / *minimum quantity 5 pieces*



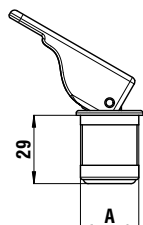
Particolare innesto Honda  
*Particular of Honda graft*



Particolare connettore femmina  
*Particular of female connector*

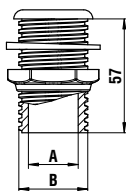


Particolare connettore maschio  
*Particular of male connector*

**COD.ORDINAZIONE / ORDER COD.**

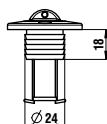
		A
<b>62.00535.00</b>	Aleggio espansione Nero <i>Black expansion plug</i>	25
<b>62.00535.01</b>	Aleggio espansione Bianco <i>White expansion plug</i>	25
<b>62.00535.02</b>	Aleggio espansione Grigio <i>Grey expansion plug</i>	25
<b>62.00543.00</b>	Aleggio espansione Nero <i>Black expansion plug</i>	35
<b>62.00543.01</b>	Aleggio espansione Bianco <i>White expansion plug</i>	35
<b>62.00543.02</b>	Aleggio espansione Grigio <i>Grey expansion plug</i>	35
<b>62.00544.00</b>	Aleggio espansione Nero <i>Black expansion plug</i>	40
<b>62.00544.01</b>	Aleggio espansione Bianco <i>White expansion plug</i>	40
<b>62.00544.02</b>	Aleggio espansione Grigio <i>Grey expansion plug</i>	40

prezzo a conf. 5 PZ. / price per 5 pieces package

**COD.ORDINAZIONE / ORDER COD.**

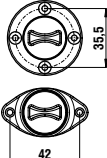
		A	B
<b>62.00536.00</b>	Tubo + rondella Nero <i>Black drain fitting</i>	25	34
<b>62.00536.01</b>	Tubo + rondella Bianco <i>White drain fitting</i>	25	34
<b>62.00572.00</b>	Tubo + rondella Nero <i>Black drain fitting</i>	35	44
<b>62.00572.01</b>	Tubo + rondella Bianco <i>White drain fitting</i>	35	44
<b>62.00573.00</b>	Tubo + rondella Nero <i>Black drain fitting</i>	40	49
<b>62.00573.01</b>	Tubo + rondella Bianco <i>White drain fitting</i>	40	49

prezzo a conf. 5 PZ. / price per 5 pieces package

**COD.ORDINAZIONE / ORDER COD.**

<b>62.00489.00</b>	Aleggio tondo foro d.19 Nero <i>Round drain plug d.19 - black</i>
<b>62.00489.01</b>	Aleggio tondo foro d.19 Bianco <i>Round drain plug d.19 - white</i>

prezzo a conf. 10 PZ. / price per 10 pieces package

**COD.ORDINAZIONE / ORDER COD.**

<b>62.00490.00</b>	Aleggio ovale foro d.19 Nero <i>Oval shape drain plug d.19 - black</i>
<b>62.00490.01</b>	Aleggio ovale foro d.19 Bianco <i>Oval shape drain plug d.19 - white</i>

prezzo a conf. 10 PZ. / price per 10 pieces package

**DESCRIZIONE / DESCRIPTION**

Foro d'ispezione / Guarnizione stagna  
 Materiale anti UV e antiolio  
*Inspection hole / Sealing gasket  
 Oil and UV resistant material*

**COD.ORDINAZIONE / ORDER COD.**

- 62.00491.00** Bianco Ø Int. 104 - Ø est. 140  
*White int. Ø 104 - est. Ø 140*
- 62.00491.01** Nero Ø int. 104 - Ø est. 140  
*Black int. Ø 104 - est. Ø 140*
- 62.00492.00** Bianco Ø int. 129 - Ø est. 165  
*White int. Ø 129 - est. Ø 165*
- 62.00492.01** Nero Ø int. 129 - Ø est. 165  
*Black int. Ø 129 - est. Ø 165*
- 62.00493.00** Bianco Ø int. 154 - Ø est. 190  
*White int. Ø 154 - est. Ø 190*
- 62.00493.01** Nero Ø int. 154 - Ø est. 190  
*Black int. Ø 154 - est. Ø 190*

**DESCRIZIONE / DESCRIPTION**

Moschettoni / Prezzo a confezione 10 PZ.  
*Spring catch / price per 10 pieces package*

**COD.ORDINAZIONE / ORDER COD.**

- 62.00521.00** Nero Ø foro per corda 8/9 mm  
*Black Ø hole for rope 8/9 mm*
- 62.00521.01** Bianco Ø foro per corda 8/9 mm  
*White Ø hole for rope 8/9 mm*
- 62.00520.00** Nero Ø foro per corda 6/7 mm  
*Black Ø hole for rope 6/7 mm*
- 62.00520.01** Bianco Ø foro per corda 6/7 mm  
*White Ø hole for rope 6/7 mm*
- 62.00519.00** Nero Ø foro per corda 4/5 mm  
*Black Ø hole for rope 4/5 mm*
- 62.00519.01** Bianco Ø foro per corda 4/5 mm  
*White Ø hole for rope 4/5 mm*
- 62.00518.00** Nero Ø foro per corda 2/3 mm  
*Black Ø hole for rope 2/3 mm*
- 62.00518.01** Bianco Ø foro per corda 2/3 mm  
*White Ø hole for rope 2/3 mm*

**DESCRIZIONE / DESCRIPTION**

Mezzo marinaio / Prezzo a confezione 10 PZ.  
*Boat hook / price per 10 pieces package*

**COD.ORDINAZIONE / ORDER COD.**

- 62.00386.00** Ø 19  
**62.00385.00** Ø 27

**DESCRIZIONE / DESCRIPTION**

Redancia / Prezzo a confezione 10 PZ.  
*Himble / price per 10 pieces package*

**COD.ORDINAZIONE / ORDER COD.**

- |                          |                          |
|--------------------------|--------------------------|
| <b>62.00388.01</b> mm 4  | <b>62.00388.08</b> mm 14 |
| <b>62.00388.02</b> mm 5  | <b>62.00388.09</b> mm 15 |
| <b>62.00388.03</b> mm 6  | <b>62.00388.10</b> mm 18 |
| <b>62.00388.04</b> mm 7  | <b>62.00388.11</b> mm 20 |
| <b>62.00388.05</b> mm 8  | <b>62.00388.12</b> mm 22 |
| <b>62.00388.06</b> mm 10 | <b>62.00388.13</b> mm 24 |
| <b>62.00388.07</b> mm 12 |                          |

**DESCRIZIONE / DESCRIPTION**

Gancio per gommone / Prezzo a confezione 10 PZ.  
*Rubber dinghy hook / price per 10 pieces package*

**COD.ORDINAZIONE / ORDER COD.**

- 62.00516.00** Nero / Black  
**62.00516.01** Bianco / White

**DESCRIZIONE / DESCRIPTION**

Gancio da parete semichiuso / Prezzo a conf. 10 PZ.  
*Half closed wall hook / price per 10 pieces package*

**COD.ORDINAZIONE / ORDER COD.**

- 62.00515.00** Nero / Black  
**62.00515.01** Bianco / White



**DESCRIZIONE / DESCRIPTION**Molla d'ormeggio / *Spring Mooring***COD.ORDINAZIONE / ORDER COD.****62.00768.00**Molla ormeggio **medio** mm 275x50x22

Diam. foro cima 12/14 - Carico di lavoro 250 Kg. per barche fino a 3 Ton.

*Medium size spring mooring mm 275x50x22**Hole diameter rope 12/14 workload 250 Kg for boats up to 3 Tons.***62.00769.00**Molla ormeggio **grande** mm 320x55x25

Diam. foro cima 16/18 - Carico di lavoro 500 Kg. per barche fino a 8 Ton.

*Big Size spring mooring mm 320x55x25**Hole diameter rope 16/18 workload 500 Kg for boats up to 8 Tons.***DESCRIZIONE / DESCRIPTION**

Gancio da parete / Prezzo a confezione 10 PZ.

*Wall hook / price per 10 pieces package***COD.ORDINAZIONE / ORDER COD.****62.00517.00 Nero / Black****62.00517.01 Bianco / White****DESCRIZIONE / DESCRIPTION**

Galloccia / Prezzo a confezione 10 PZ.

*Cleat / price per 10 pieces package***COD.ORDINAZIONE / ORDER COD.****62.00389.00** Lungh 110 / *Length 110***62.00390.00** Lungh 165 / *Length 165***62.00391.00** Lungh 220 / *Length 220***DESCRIZIONE / DESCRIPTION**Supporti elastici / Prezzo a confezione 10 PZ. / *Spring clips / price per 10 pieces package***COD.ORDINAZIONE / ORDER COD.****62.00528.00 Nero Ø 45 / Black Ø 45****62.00528.01 Bianco Ø 45 / White Ø 45****62.00527.00 Nero Ø 40 / Black Ø 40****62.00527.01 Bianco Ø 40 / White Ø 40****62.00526.00 Nero Ø 35 / Black Ø 35****62.00526.01 Bianco Ø 35 / White Ø 35****62.00525.00 Nero Ø 30 / Black Ø 30****62.00525.01 Bianco Ø 30 / White Ø 30****62.00524.00 Nero Ø 25 / Black Ø 25****62.00524.01 Bianco Ø 25 / White Ø 25****62.00523.00 Nero Ø 20 / Black Ø 20****62.00523.01 Bianco Ø 20 / White Ø 20****62.00522.00 Nero Ø 15 / Black Ø 15****62.00522.01 Bianco Ø 15 / White Ø 15**



CE R2009

**DESCRIZIONE / DESCRIPTION**

Serbatoio verticale Eltex  
Capacità 22 litri  
Completo di indicatore di livello , pescante e tappo con sfiato  
Riserva 2 litri  
Dimensioni 405x330x240

*Eltex vertical tank  
22 lt capacity  
With fuel gauge, dip-tube and vent cap  
2 lt reserve  
Dimensions : 405x330x240*

**COD.ORDINAZIONE / ORDER COD. 62.00467.00**



CE R2010

**DESCRIZIONE / DESCRIPTION**

Serbatoio orizzontale Eltex  
Capacità 12 litri  
Completo di pescante e tappo con sfiato  
Riserva 2 litri  
Dimensioni 400x280x170

*Horizontal tank Eltex  
12 lt capacity  
With dip-tube and vent cap  
2 lt reserve  
Dimensions : 400x280x170*

**COD.ORDINAZIONE / ORDER COD. 62.00468.00**



CE R2011

**DESCRIZIONE / DESCRIPTION**

Serbatoio orizz. Eltex  
Capacità 23 litri  
Completo di indicatore di livello , pescante e tappo con sfiato  
Riserva 3 litri  
Dimensioni 460x340x230

*Eltex horizontal tank  
23 lt capacity  
With fuel gauge, dip-tube  
and vent cap 3 lt reserve  
Dimensions : 460x340x230*

**COD.ORDINAZIONE / ORDER COD. 62.00469.00**



CE R2012

**DESCRIZIONE / DESCRIPTION**

Serbatoio orizz. Eltex  
Capacità 30 litri  
Completo di indicatore di livello,pescante e tappo con sfiato  
Riserva 3 litri  
Conforme RINA

*Eltex horizontal tank  
30 lt capacity  
With fuel gauge, dip-tube  
and vent cap 3 lt reserve  
In conformity with RINA regulations  
dimensions : 510x365x230*

**COD.ORDINAZIONE / ORDER COD. 62.00470.00**

**RICAMBIO / REPLACEMENT**

**DESCRIZIONE / DESCRIPTION**

Attacchi rapidi serbatoio / Quick connections for tank



**COD.ORDINAZIONE / ORDER COD.**

**62.00782.00** (per R2009) / (for R2009)

**62.00782.01** (per R2010) / (for R2010)

**62.00782.02** (per R2011/2012) / (for R2011/2012)

**ACCESSORIO OPZIONALE / OPTIONAL ACCESSORIES**

**DESCRIZIONE / DESCRIPTION**

Tappo con sfiato e misuratore di livello  
Cap with vent and level meter



**COD.ORDINAZIONE / ORDER COD.**

**62.00783.00** (per R2010) / (for R2010)

**62.00783.01** (per R2011/R2012) / (for R2011/R2012)

SEVERAL ACCESSORIES

# LISTINO RIVIERA 2020 / PRICE LIST RIVIERA 2020

CODICE/CODE	PREZZO/PRICE €*	PAG.	CODICE/CODE	PREZZO/PRICE €*	PAG.
60.01025.00	€ 4,10	92	62.00000.38	€ 58,60	157
60.01063.00	€ 9,90	89	62.00000.39	€ 59,40	157
60.01063.10	€ 32,70	89	62.00000.40	€ 60,10	157
60.01063.20	€ 32,70	89	62.00001.05	€ 26,50	157
60.01064.00	€ 6,00	90	62.00001.06	€ 27,70	157
60.01064.10	€ 24,50	90	62.00001.07	€ 28,80	157
60.01064.20	€ 24,50	90	62.00001.08	€ 29,90	157
60.01090.00	€ 11,50	91	62.00001.09	€ 31,20	157
60.01091.00	€ 11,50	91	62.00001.10	€ 32,40	157
60.01104.00	€ 13,00	89	62.00001.11	€ 33,40	157
60.02676.00	€ 13,40	148	62.00001.12	€ 34,60	157
60.02676.00	€ 13,40	149	62.00001.13	€ 35,90	157
60.02676.00	€ 13,40	150	62.00001.14	€ 37,10	157
60.02676.01	€ 13,40	148	62.00001.15	€ 38,40	157
60.02676.01	€ 13,40	149	62.00001.16	€ 39,50	157
60.02676.01	€ 13,40	150	62.00001.17	€ 40,70	157
60.03259.00	€ 20,80	46	62.00001.18	€ 41,90	157
60.03272.10	€ 19,80	45	62.00001.19	€ 43,00	157
60.03275.00	€ 9,90	93	62.00001.20	€ 44,20	157
60.03275.00	€ 9,90	94	62.00001.21	€ 45,60	157
60.03276.00	€ 6,00	95	62.00001.22	€ 47,00	157
61.01054.00	€ 4,80	71	62.00001.23	€ 48,30	157
61.01054.00	€ 4,80	73	62.00001.24	€ 49,50	157
61.01129.00	€ 45,00	136	62.00001.25	€ 50,70	157
61.01132.00	€ 38,00	136	62.00001.26	€ 53,00	157
62.00000.05	€ 22,30	157	62.00001.27	€ 55,10	157
62.00000.06	€ 23,30	157	62.00001.28	€ 57,60	157
62.00000.07	€ 24,20	157	62.00001.29	€ 59,80	157
62.00000.08	€ 25,00	157	62.00001.30	€ 62,00	157
62.00000.09	€ 26,20	157	62.00001.31	€ 64,40	157
62.00000.10	€ 27,30	157	62.00001.32	€ 66,80	157
62.00000.11	€ 28,20	157	62.00001.33	€ 69,00	157
62.00000.12	€ 29,00	157	62.00001.34	€ 71,20	157
62.00000.13	€ 29,90	157	62.00001.35	€ 73,70	157
62.00000.14	€ 31,00	157	62.00001.36	€ 76,10	157
62.00000.15	€ 31,90	157	62.00001.37	€ 78,60	157
62.00000.16	€ 32,80	157	62.00001.38	€ 81,00	157
62.00000.17	€ 33,70	157	62.00001.39	€ 83,40	157
62.00000.18	€ 34,70	157	62.00001.40	€ 85,90	157
62.00000.19	€ 35,60	157	62.00002.05	€ 27,40	161
62.00000.20	€ 36,80	157	62.00002.06	€ 28,20	161
62.00000.21	€ 37,90	157	62.00002.07	€ 29,10	161
62.00000.22	€ 38,90	157	62.00002.08	€ 30,00	161
62.00000.23	€ 39,90	157	62.00002.09	€ 32,00	161
62.00000.24	€ 41,00	157	62.00002.10	€ 32,10	161
62.00000.25	€ 42,10	157	62.00002.11	€ 32,90	161
62.00000.26	€ 42,80	157	62.00002.12	€ 33,90	161
62.00000.27	€ 45,70	157	62.00002.13	€ 34,70	161
62.00000.28	€ 46,50	157	62.00002.14	€ 35,80	161
62.00000.29	€ 48,60	157	62.00002.15	€ 36,90	161
62.00000.30	€ 49,30	157	62.00002.16	€ 37,90	161
62.00000.31	€ 50,10	157	62.00002.17	€ 38,70	161
62.00000.32	€ 51,00	157	62.00002.18	€ 39,60	161
62.00000.33	€ 51,70	157	62.00002.19	€ 40,50	161
62.00000.34	€ 55,20	157	62.00002.20	€ 41,70	161
62.00000.35	€ 56,20	157	62.00002.21	€ 42,70	161
62.00000.36	€ 57,00	157	62.00002.22	€ 43,70	161
62.00000.37	€ 57,80	157	62.00002.23	€ 44,80	161

\* IVA ESCLUSA / \* VAT EXCLUDED

\* IVA ESCLUSA / \* VAT EXCLUDED

CODICE/CODE	PREZZO/PRICE €*	PAG.
62.00002.24	€ 45,80	161
62.00002.25	€ 46,40	161
62.00002.26	€ 47,30	161
62.00002.27	€ 48,30	161
62.00002.28	€ 48,90	161
62.00002.29	€ 49,50	161
62.00002.30	€ 50,40	161
62.00002.31	€ 51,60	161
62.00002.32	€ 52,30	161
62.00002.33	€ 52,90	161
62.00002.34	€ 53,80	161
62.00002.35	€ 54,40	161
62.00002.36	€ 55,70	161
62.00002.37	€ 56,50	161
62.00002.38	€ 57,30	161
62.00002.39	€ 58,30	161
62.00002.40	€ 61,00	161
62.00003.05	€ 37,10	159
62.00003.06	€ 38,10	159
62.00003.07	€ 38,90	159
62.00003.08	€ 39,80	159
62.00003.09	€ 40,80	159
62.00003.10	€ 41,90	159
62.00003.11	€ 42,80	159
62.00003.12	€ 43,60	159
62.00003.13	€ 44,60	159
62.00003.14	€ 45,60	159
62.00003.15	€ 46,70	159
62.00003.16	€ 47,60	159
62.00003.17	€ 48,60	159
62.00003.18	€ 49,50	159
62.00003.19	€ 50,30	159
62.00003.20	€ 51,40	159
62.00003.21	€ 52,50	159
62.00003.22	€ 53,50	159
62.00003.23	€ 54,50	159
62.00003.24	€ 55,70	159
62.00003.25	€ 56,80	159
62.00003.26	€ 58,70	159
62.00003.27	€ 60,60	159
62.00003.28	€ 62,60	159
62.00003.29	€ 64,50	159
62.00003.30	€ 66,60	159
62.00003.31	€ 68,50	159
62.00003.32	€ 70,40	159
62.00003.33	€ 72,30	159
62.00003.34	€ 74,20	159
62.00003.35	€ 77,20	159
62.00003.36	€ 78,50	159
62.00003.37	€ 80,30	159
62.00003.38	€ 82,60	159
62.00003.39	€ 84,60	159
62.00003.40	€ 86,80	159
62.00004.03	€ 42,60	159
62.00004.05	€ 27,40	158
62.00004.06	€ 28,30	158
62.00004.07	€ 29,20	158
62.00004.08	€ 30,00	158
62.00004.09	€ 31,10	158
62.00004.10	€ 32,00	158
62.00004.11	€ 33,00	158

\* IVA ESCLUSA / \* VAT EXCLUDED

CODICE/CODE	PREZZO/PRICE €*	PAG.
62.00004.12	€ 33,90	158
62.00004.13	€ 34,80	158
62.00004.14	€ 35,80	158
62.00004.15	€ 36,90	158
62.00004.16	€ 37,90	158
62.00004.17	€ 38,80	158
62.00004.18	€ 39,70	158
62.00004.19	€ 40,50	158
62.00004.20	€ 41,70	158
62.00004.21	€ 42,70	158
62.00004.22	€ 43,70	158
62.00004.23	€ 44,80	158
62.00004.24	€ 45,80	158
62.00004.25	€ 46,60	158
62.00004.26	€ 47,40	158
62.00004.27	€ 48,10	158
62.00004.28	€ 48,80	158
62.00004.29	€ 49,40	158
62.00004.30	€ 50,40	158
62.00004.31	€ 51,40	158
62.00004.32	€ 52,40	158
62.00004.33	€ 53,40	158
62.00004.34	€ 54,10	158
62.00004.35	€ 54,70	158
62.00004.36	€ 56,00	158
62.00004.37	€ 57,30	158
62.00004.38	€ 57,90	158
62.00004.39	€ 59,20	158
62.00004.40	€ 60,00	158
62.00005.07	€ 87,10	104
62.00005.08	€ 89,70	104
62.00005.09	€ 92,30	104
62.00005.10	€ 94,80	104
62.00005.11	€ 97,40	104
62.00005.12	€ 100,00	104
62.00005.13	€ 102,60	104
62.00005.14	€ 105,00	104
62.00005.15	€ 107,70	104
62.00005.16	€ 110,30	104
62.00005.17	€ 112,90	104
62.00005.18	€ 115,30	104
62.00005.19	€ 118,00	104
62.00005.20	€ 120,60	104
62.00005.21	€ 123,10	104
62.00005.22	€ 125,60	104
62.00005.23	€ 128,30	104
62.00005.24	€ 130,90	104
62.00005.25	€ 133,40	104
62.00005.26	€ 135,90	104
62.00005.27	€ 138,60	104
62.00005.28	€ 141,20	104
62.00005.29	€ 143,70	104
62.00005.30	€ 146,20	104
62.00005.31	€ 151,90	104
62.00005.32	€ 157,40	104
62.00005.33	€ 163,00	104
62.00005.34	€ 168,60	104
62.00005.35	€ 174,10	104
62.00005.36	€ 179,70	104
62.00005.37	€ 185,30	104
62.00005.38	€ 190,80	104

\* IVA ESCLUSA / \* VAT EXCLUDED



CODICE/CODE	PREZZO/PRICE €*	PAG.
62.00005.39	€ 196,40	104
62.00005.40	€ 202,00	104
62.00006.00	€ 64,10	105
62.00007.01	€ 124,90	145
62.00007.02	€ 124,90	145
62.00008.01	€ 154,90	145
62.00008.02	€ 154,90	145
62.00010.01	€ 124,90	146
62.00010.02	€ 124,90	146
62.00013.01	€ 300,50	30
62.00013.10	€ 300,50	30
62.00015.01	€ 338,10	30
62.00017.01	€ 257,30	30
62.00019.01	€ 292,30	30
62.00021.01	€ 356,60	28
62.00021.10	€ 356,60	28
62.00023.01	€ 397,10	28
62.00025.01	€ 315,10	28
62.00027.01	€ 353,50	28
62.00035.01	€ 173,10	38
62.00036.01	€ 193,90	38
62.00036.10	€ 193,90	38
62.00037.01	€ 193,90	36
62.00038.01	€ 213,60	36
62.00038.10	€ 213,60	36
62.00039.01	€ 174,20	38
62.00040.01	€ 193,90	38
62.00040.10	€ 193,90	38
62.00041.01	€ 193,90	35
62.00042.01	€ 213,60	35
62.00042.10	€ 213,60	35
62.00043.02	€ 139,80	49
62.00043.03	€ 139,80	49
62.00043.04	€ 139,80	49
62.00043.05	€ 139,80	49
62.00044.02	€ 163,80	50
62.00044.03	€ 163,80	50
62.00044.04	€ 163,80	50
62.00044.05	€ 163,80	50
62.00047.01	€ 15,20	49
62.00048.01	€ 15,20	38
62.00048.01	€ 15,20	50
62.00051.01	€ 292,30	29
62.00052.01	€ 256,70	29
62.00053.01	€ 300,50	29
62.00053.10	€ 300,50	29
62.00054.01	€ 353,50	27
62.00055.01	€ 315,10	27
62.00056.01	€ 356,60	27
62.00056.10	€ 356,60	27
62.00058.02	€ 49,20	71
62.00059.02	€ 49,20	71
62.00062.01	€ 16,50	35
62.00062.01	€ 16,50	27
62.00063.01	€ 15,20	35
62.00063.01	€ 15,20	36
62.00064.01	€ 14,10	62
62.00068.02	€ 49,20	71
62.00073.01	€ 471,40	24
62.00074.01	€ 431,50	24
62.00075.01	€ 536,00	23

\* IVA ESCLUSA / \* VAT EXCLUDED

CODICE/CODE	PREZZO/PRICE €*	PAG.
62.00076.01	€ 491,10	23
62.00077.01	€ 471,40	24
62.00078.01	€ 431,50	24
62.00079.01	€ 536,00	23
62.00080.01	€ 491,10	23
62.00081.01	€ 516,30	24
62.00082.01	€ 473,70	24
62.00083.01	€ 576,90	23
62.00084.01	€ 532,10	23
62.00093.01	€ 165,00	78
62.00099.01	€ 516,30	24
62.00100.01	€ 473,70	24
62.00101.01	€ 576,90	23
62.00102.01	€ 532,10	23
62.00103.01	€ 207,10	35
62.00104.01	€ 42,60	22
62.00105.01	€ 41,50	78
62.00106.01	€ 96,60	78
62.00107.01	€ 516,30	22
62.00108.01	€ 572,50	22
62.00112.01	€ 207,10	35
62.00113.01	€ 315,10	27
62.00114.01	€ 101,00	67
62.00115.01	€ 104,30	68
62.00116.01	€ 104,30	68
62.00117.01	€ 29,50	27
62.00125.01	€ 388,90	34
62.00126.01	€ 410,70	34
62.00127.01	€ 388,90	34
62.00128.01	€ 410,70	34
62.00129.01	€ 523,30	26
62.00130.01	€ 565,30	26
62.00131.01	€ 523,30	26
62.00132.01	€ 565,30	26
62.00133.01	€ 773,10	22
62.00134.01	€ 831,50	22
62.00136.01	€ 619,60	26
62.00137.01	€ 576,90	26
62.00138.01	€ 619,60	26
62.00139.01	€ 576,90	26
62.00140.01	€ 397,10	27
62.00141.01	€ 353,50	27
62.00142.01	€ 338,10	29
62.00143.01	€ 133,20	63
62.00144.01	€ 121,80	63
62.00145.01	€ 137,10	62
62.00146.01	€ 124,00	62
62.00147.01	€ 145,80	62
62.00148.01	€ 130,60	62
62.00150.01	€ 230,60	35
62.00151.01	€ 207,60	38
62.00152.01	€ 230,60	36
62.00153.01	€ 207,60	38
62.00154.01	€ 129,40	22
62.00155.01	€ 118,00	26
62.00156.01	€ 100,50	34
62.00157.01	€ 222,20	35
62.00158.01	€ 217,20	35
62.00158.10	€ 217,20	35
62.00180.01	€ 11,40	27
62.00202.01	€ 28,40	76

\* IVA ESCLUSA / \* VAT EXCLUDED



CODICE/CODE	PREZZO/PRICE €*	PAG.
62.00203.01	€ 29,50	76
62.00301.01	€ 101,00	67
62.00301.02	€ 101,00	67
62.00304.01	€ 104,30	68
62.00304.02	€ 104,30	68
62.00305.01	€ 104,30	68
62.00305.02	€ 104,30	68
62.00309.01	€ 133,20	63
62.00309.02	€ 133,20	63
62.00311.01	€ 121,80	63
62.00311.02	€ 121,80	63
62.00312.01	€ 137,10	62
62.00312.02	€ 137,10	62
62.00313.01	€ 124,00	62
62.00313.02	€ 124,00	62
62.00314.01	€ 145,80	62
62.00314.02	€ 145,80	62
62.00315.01	€ 130,60	62
62.00315.02	€ 130,60	62
62.00316.01	€ 28,40	76
62.00317.01	€ 29,50	76
62.00318.01	€ 173,10	38
62.00321.01	€ 193,90	38
62.00336.01	€ 51,70	92
62.00336.10	€ 55,70	92
62.00338.01	€ 60,60	92
62.00338.10	€ 64,70	92
62.00350.01	€ 48,40	92
62.00350.10	€ 52,40	92
62.00352.01	€ 48,40	92
62.00352.10	€ 52,40	92
62.00354.02	€ 49,20	71
62.00355.02	€ 49,20	71
62.00356.07	€ 95,10	104
62.00356.08	€ 98,30	104
62.00356.09	€ 101,30	104
62.00356.10	€ 104,40	104
62.00356.11	€ 107,60	104
62.00356.12	€ 110,70	104
62.00356.13	€ 113,80	104
62.00356.14	€ 116,90	104
62.00356.15	€ 120,10	104
62.00356.16	€ 123,10	104
62.00356.17	€ 126,10	104
62.00356.18	€ 129,30	104
62.00356.19	€ 132,40	104
62.00356.20	€ 135,50	104
62.00356.21	€ 138,70	104
62.00356.22	€ 141,80	104
62.00356.23	€ 144,90	104
62.00356.24	€ 148,00	104
62.00356.25	€ 151,10	104
62.00356.26	€ 154,20	104
62.00356.27	€ 157,30	104
62.00356.28	€ 160,40	104
62.00356.29	€ 163,50	104
62.00356.30	€ 166,70	104
62.00356.31	€ 173,40	104
62.00356.32	€ 180,10	104
62.00356.33	€ 186,90	104
62.00356.34	€ 193,60	104

\* IVA ESCLUSA / \* VAT EXCLUDED

CODICE/CODE	PREZZO/PRICE €*	PAG.
62.00356.35	€ 200,40	104
62.00356.36	€ 207,20	104
62.00356.37	€ 213,90	104
62.00356.38	€ 220,70	104
62.00356.39	€ 227,50	104
62.00356.40	€ 234,20	104
62.00358.00	€ 75,30	105
62.00359.00	€ 30,80	110
62.00362.00	€ 42,30	110
62.00363.00	€ 71,40	106
62.00364.00	€ 4,90	162
62.00366.00	€ 10,50	110
62.00367.02	€ 49,20	71
62.00369.00	€ 35,90	162
62.00370.00	€ 29,50	162
62.00380.01	€ 3,40	110
62.00380.02	€ 3,40	110
62.00380.03	€ 3,40	110
62.00381.01	€ 3,70	110
62.00381.02	€ 3,70	110
62.00381.03	€ 3,70	110
62.00382.01	€ 5,80	110
62.00382.02	€ 5,80	110
62.00382.03	€ 5,80	110
62.00383.01	€ 3,30	110
62.00383.02	€ 3,30	110
62.00384.01	€ 3,60	110
62.00384.02	€ 3,60	110
62.00384.03	€ 3,60	110
62.00385.00	€ 13,60	169
62.00386.00	€ 12,90	169
62.00387.01	€ 3,70	110
62.00387.02	€ 3,70	110
62.00387.03	€ 3,70	110
62.00388.01	€ 2,30	169
62.00388.02	€ 2,30	169
62.00388.03	€ 2,70	169
62.00388.04	€ 2,70	169
62.00388.05	€ 2,90	169
62.00388.06	€ 3,50	169
62.00388.07	€ 4,20	169
62.00388.08	€ 4,60	169
62.00388.09	€ 6,80	169
62.00388.10	€ 8,90	169
62.00388.11	€ 11,60	169
62.00388.12	€ 15,50	169
62.00388.13	€ 18,20	169
62.00389.00	€ 8,60	170
62.00390.00	€ 10,80	170
62.00391.00	€ 16,30	170
62.00405.04	€ 49,20	73
62.00405.05	€ 49,20	73
62.00405.06	€ 49,20	73
62.00405.07	€ 49,20	73
62.00405.08	€ 49,20	73
62.00405.09	€ 49,20	73
62.00405.14	€ 58,50	73
62.00405.15	€ 58,50	73
62.00405.16	€ 58,50	73
62.00405.17	€ 58,50	73
62.00405.18	€ 58,50	73

\* IVA ESCLUSA / \* VAT EXCLUDED



CODICE/CODE	PREZZO/PRICE €*	PAG.
62.00405.19	€ 58,50	73
62.00409.00	€ 6,60	166
62.00410.00	€ 7,10	166
62.00411.00	€ 6,60	166
62.00412.00	€ 7,60	166
62.00413.00	€ 6,40	166
62.00413.01	€ 7,40	166
62.00414.00	€ 6,10	166
62.00415.00	€ 6,60	166
62.00416.00	€ 6,40	166
62.00416.01	€ 7,40	166
62.00417.00	€ 6,60	166
62.00420.00	€ 32,20	80
62.00420.01	€ 32,20	80
62.00420.02	€ 32,20	80
62.00420.03	€ 32,20	80
62.00420.04	€ 32,20	80
62.00421.05	€ 28,90	158
62.00421.06	€ 29,50	158
62.00421.07	€ 30,10	158
62.00421.08	€ 30,90	158
62.00421.09	€ 31,40	158
62.00421.10	€ 32,10	158
62.00421.11	€ 33,20	158
62.00421.12	€ 33,90	158
62.00421.13	€ 34,80	158
62.00421.14	€ 35,80	158
62.00421.15	€ 36,50	158
62.00421.16	€ 37,10	158
62.00421.17	€ 38,10	158
62.00421.18	€ 39,00	158
62.00421.19	€ 39,80	158
62.00421.20	€ 40,50	158
62.00421.21	€ 41,20	158
62.00421.22	€ 42,10	158
62.00421.23	€ 42,70	158
62.00421.24	€ 43,60	158
62.00421.25	€ 44,20	158
62.00421.26	€ 45,20	158
62.00421.27	€ 46,20	158
62.00421.28	€ 48,10	158
62.00421.29	€ 49,90	158
62.00421.30	€ 51,30	158
62.00421.31	€ 52,60	158
62.00421.32	€ 53,20	158
62.00421.33	€ 54,40	158
62.00421.34	€ 56,50	158
62.00421.35	€ 57,10	158
62.00421.36	€ 58,50	158
62.00421.37	€ 59,80	158
62.00421.38	€ 60,40	158
62.00421.39	€ 62,30	158
62.00421.40	€ 63,00	158
62.00423.01	€ 70,40	88
62.00423.10	€ 95,00	88
62.00423.20	€ 95,00	88
62.00424.01	€ 114,70	88
62.00424.10	€ 139,30	88
62.00424.20	€ 139,30	88
62.00425.01	€ 65,40	90
62.00425.10	€ 90,20	90

\* IVA ESCLUSA / \* VAT EXCLUDED

CODICE/CODE	PREZZO/PRICE €*	PAG.
62.00425.20	€ 90,20	90
62.00426.01	€ 86,90	90
62.00426.10	€ 111,40	90
62.00426.20	€ 111,40	90
62.00428.01	€ 114,70	88
62.00428.10	€ 139,30	88
62.00428.20	€ 139,30	88
62.00429.01	€ 74,50	90
62.00429.10	€ 96,00	90
62.00429.20	€ 96,00	90
62.00431.05	€ 29,30	160
62.00431.06	€ 29,90	160
62.00431.07	€ 30,60	160
62.00431.08	€ 31,20	160
62.00431.09	€ 31,80	160
62.00431.10	€ 32,30	160
62.00431.11	€ 34,30	160
62.00431.12	€ 34,80	160
62.00431.13	€ 35,50	160
62.00431.14	€ 36,50	160
62.00431.15	€ 37,10	160
62.00431.16	€ 38,20	160
62.00431.17	€ 38,70	160
62.00431.18	€ 39,60	160
62.00431.19	€ 40,20	160
62.00431.20	€ 41,60	160
62.00431.21	€ 42,20	160
62.00431.22	€ 42,80	160
62.00431.23	€ 43,60	160
62.00431.24	€ 44,20	160
62.00431.25	€ 44,80	160
62.00431.26	€ 46,00	160
62.00431.27	€ 47,30	160
62.00431.28	€ 47,90	160
62.00431.29	€ 49,70	160
62.00431.30	€ 51,00	160
62.00431.31	€ 52,30	160
62.00431.32	€ 52,90	160
62.00431.33	€ 53,50	160
62.00431.34	€ 54,70	160
62.00431.35	€ 55,40	160
62.00431.36	€ 56,80	160
62.00431.37	€ 57,50	160
62.00431.38	€ 58,90	160
62.00431.39	€ 60,10	160
62.00431.40	€ 65,90	160
62.00444.01	€ 137,10	57
62.00444.02	€ 137,10	57
62.00444.03	€ 137,10	57
62.00445.01	€ 124,00	57
62.00445.02	€ 124,00	57
62.00445.03	€ 124,00	57
62.00446.01	€ 139,30	58
62.00446.02	€ 139,30	58
62.00446.03	€ 139,30	58
62.00447.01	€ 126,10	58
62.00447.02	€ 126,10	58
62.00447.03	€ 126,10	58
62.00448.01	€ 148,10	58
62.00448.02	€ 148,10	58
62.00448.03	€ 148,10	58

\* IVA ESCLUSA / \* VAT EXCLUDED

CODICE/CODE	PREZZO/PRICE €*	PAG.
62.00449.01	€ 133,20	58
62.00449.02	€ 133,20	58
62.00449.03	€ 133,20	58
62.00450.00	€ 7,30	165
62.00450.10	€ 9,70	165
62.00451.00	€ 8,10	165
62.00451.10	€ 10,30	165
62.00452.00	€ 21,00	165
62.00453.00	€ 26,50	165
62.00454.00	€ 25,30	165
62.00455.00	€ 29,70	165
62.00456.00	€ 204,60	165
62.00456.25	€ 117,90	165
62.00457.00	€ 229,30	165
62.00457.25	€ 135,00	165
62.00466.00	€ 28,40	162
62.00467.00	€ 34,10	171
62.00468.00	€ 25,40	171
62.00469.00	€ 34,10	171
62.00470.00	€ 42,80	171
62.00482.00	€ 6,10	167
62.00483.00	€ 4,70	167
62.00484.00	€ 45,80	80
62.00484.01	€ 45,80	80
62.00484.02	€ 45,80	80
62.00484.03	€ 45,80	80
62.00484.04	€ 45,80	80
62.00486.00	€ 12,80	167
62.00489.00	€ 11,60	168
62.00489.01	€ 11,60	168
62.00490.00	€ 11,60	168
62.00490.01	€ 11,60	168
62.00491.00	€ 3,80	169
62.00491.01	€ 3,80	169
62.00492.00	€ 4,00	169
62.00492.01	€ 4,00	169
62.00493.00	€ 4,20	169
62.00493.01	€ 4,20	169
62.00494.01	€ 40,10	91
62.00494.02	€ 40,10	91
62.00495.00	€ 13,80	167
62.00496.00	€ 11,70	167
62.00497.00	€ 56,80	139
62.00497.01	€ 56,80	139
62.00497.02	€ 56,80	139
62.00499.00	€ 49,80	139
62.00499.01	€ 49,80	139
62.00499.02	€ 49,80	139
62.00499.03	€ 49,80	139
62.00505.00	€ 27,90	98
62.00506.01	€ 193,90	36
62.00507.01	€ 193,90	35
62.00508.01	€ 139,80	49
62.00508.02	€ 139,80	49
62.00508.03	€ 139,80	49
62.00508.04	€ 139,80	49
62.00509.01	€ 163,80	50
62.00509.02	€ 163,80	50
62.00509.03	€ 163,80	50
62.00509.04	€ 163,80	50
62.00512.00	€ 9,30	110

\* IVA ESCLUSA / \* VAT EXCLUDED

CODICE/CODE	PREZZO/PRICE €*	PAG.
62.00513.00	€ 40,70	162
62.00514.00	€ 22,00	162
62.00515.00	€ 4,00	169
62.00515.01	€ 4,00	169
62.00516.00	€ 4,60	169
62.00516.01	€ 4,60	169
62.00517.00	€ 4,00	170
62.00517.01	€ 4,00	170
62.00518.00	€ 2,60	169
62.00518.01	€ 2,60	169
62.00519.00	€ 3,00	169
62.00519.01	€ 3,00	169
62.00520.00	€ 4,00	169
62.00520.01	€ 4,00	169
62.00521.00	€ 5,60	169
62.00521.01	€ 5,60	169
62.00522.00	€ 4,30	170
62.00522.01	€ 4,30	170
62.00523.00	€ 4,40	170
62.00523.01	€ 4,40	170
62.00524.00	€ 4,50	170
62.00524.01	€ 4,50	170
62.00525.00	€ 4,60	170
62.00525.01	€ 4,60	170
62.00526.00	€ 5,20	170
62.00526.01	€ 5,20	170
62.00527.00	€ 5,40	170
62.00527.01	€ 5,40	170
62.00528.00	€ 6,40	170
62.00528.01	€ 6,40	170
62.00529.00	€ 34,70	162
62.00535.00	€ 12,90	168
62.00535.01	€ 12,90	168
62.00535.02	€ 12,90	168
62.00536.00	€ 17,00	168
62.00536.01	€ 17,00	168
62.00538.00	€ 46,10	139
62.00538.01	€ 46,10	139
62.00538.02	€ 46,10	139
62.00538.03	€ 46,10	139
62.00540.00	€ 225,00	147
62.00541.00	€ 392,90	147
62.00542.00	€ 79,40	163
62.00543.00	€ 21,90	168
62.00543.01	€ 21,90	168
62.00543.02	€ 21,90	168
62.00544.00	€ 25,70	168
62.00544.01	€ 25,70	168
62.00544.02	€ 25,70	168
62.00545.00	€ 275,30	148
62.00545.01	€ 275,30	148
62.00545.20	€ 275,30	148
62.00545.21	€ 275,30	148
62.00545.40	€ 275,30	148
62.00545.41	€ 275,30	148
62.00545.50	€ 275,30	148
62.00545.51	€ 275,30	148
62.00546.00	€ 39,90	162
62.00547.07	€ 151,30	108
62.00547.08	€ 153,80	108
62.00547.09	€ 156,40	108

\* IVA ESCLUSA / \* VAT EXCLUDED



CODICE/CODE	PREZZO/PRICE €*	PAG.	CODICE/CODE	PREZZO/PRICE €*	PAG.
62.00547.10	€ 159,10	108	62.00569.00	€ 3,90	164
62.00547.11	€ 161,60	108	62.00570.00	€ 3,90	164
62.00547.12	€ 164,10	108	62.00571.00	€ 286,90	149
62.00547.13	€ 166,80	108	62.00571.01	€ 286,90	149
62.00547.14	€ 169,30	108	62.00571.20	€ 286,90	149
62.00547.15	€ 171,90	108	62.00571.21	€ 286,90	149
62.00547.16	€ 174,40	108	62.00571.40	€ 286,90	149
62.00547.17	€ 177,10	108	62.00571.41	€ 286,90	149
62.00547.18	€ 179,60	108	62.00571.50	€ 286,90	149
62.00547.19	€ 182,20	108	62.00571.51	€ 286,90	149
62.00547.20	€ 184,70	108	62.00572.00	€ 27,30	168
62.00548.07	€ 170,60	108	62.00572.01	€ 27,30	168
62.00548.08	€ 173,70	108	62.00573.00	€ 29,90	168
62.00548.09	€ 176,80	108	62.00573.01	€ 29,90	168
62.00548.10	€ 179,90	108	62.00574.00	€ 286,90	149
62.00548.11	€ 183,00	108	62.00574.01	€ 286,90	149
62.00548.12	€ 186,10	108	62.00574.10	€ 286,90	149
62.00548.13	€ 189,30	108	62.00574.11	€ 286,90	149
62.00548.14	€ 192,30	108	62.00574.20	€ 286,90	149
62.00548.15	€ 195,40	108	62.00574.21	€ 286,90	149
62.00548.16	€ 198,60	108	62.00574.40	€ 286,90	149
62.00548.17	€ 201,60	108	62.00574.41	€ 286,90	149
62.00548.18	€ 204,70	108	62.00581.00	€ 159,60	63
62.00548.19	€ 207,90	108	62.00581.01	€ 159,60	63
62.00548.20	€ 211,00	108	62.00581.02	€ 159,60	63
62.00549.07	€ 166,50	109	62.00581.03	€ 159,60	63
62.00549.08	€ 169,70	109	62.00583.00	€ 626,00	119
62.00549.09	€ 172,70	109	62.00593.00	€ 478,50	118
62.00549.10	€ 175,80	109	62.00597.00	€ 23,50	136
62.00549.11	€ 179,00	109	62.00599.00	€ 392,90	150
62.00549.12	€ 182,10	109	62.00599.10	€ 392,90	150
62.00549.13	€ 185,20	109	62.00599.20	€ 392,90	150
62.00549.14	€ 188,30	109	62.00599.30	€ 392,90	150
62.00549.15	€ 191,50	109	62.00600.00	€ 543,90	118
62.00549.16	€ 194,50	109	62.00600.00	€ 543,90	123
62.00549.17	€ 197,60	109	62.00601.00	€ 575,70	119
62.00549.18	€ 200,70	109	62.00603.30	€ 96,60	137
62.00549.19	€ 203,80	109	62.00603.35	€ 105,90	137
62.00549.20	€ 206,90	109	62.00603.40	€ 115,40	137
62.00550.00	€ 65,30	162	62.00603.45	€ 125,10	137
62.00552.00	€ 79,40	163	62.00603.50	€ 134,60	137
62.00556.00	€ 275,30	148	62.00603.55	€ 144,20	137
62.00556.01	€ 275,30	148	62.00603.60	€ 153,60	137
62.00556.20	€ 275,30	148	62.00603.65	€ 163,30	137
62.00556.21	€ 275,30	148	62.00603.70	€ 172,80	137
62.00556.30	€ 275,30	148	62.00603.75	€ 182,40	137
62.00556.31	€ 275,30	148	62.00603.80	€ 191,90	137
62.00556.40	€ 275,30	148	62.00603.85	€ 201,40	137
62.00556.41	€ 275,30	148	62.00603.90	€ 211,00	137
62.00557.00	€ 5,20	164	62.00604.00	€ 14,10	136
62.00558.00	€ 5,20	164	62.00607.00	€ 37,10	135
62.00559.00	€ 5,20	164	62.00608.00	€ 52,30	135
62.00560.00	€ 5,20	164	62.00609.00	€ 96,70	135
62.00561.00	€ 5,20	164	62.00610.00	€ 144,00	135
62.00562.00	€ 5,20	164	62.00612.00	€ 286,90	150
62.00563.00	€ 5,20	164	62.00612.01	€ 286,90	150
62.00564.00	€ 3,90	164	62.00612.10	€ 286,90	150
62.00565.00	€ 3,90	164	62.00612.11	€ 286,90	150
62.00566.00	€ 3,90	164	62.00612.20	€ 286,90	150
62.00567.00	€ 3,90	164	62.00612.21	€ 286,90	150
62.00568.00	€ 3,90	164	62.00612.40	€ 286,90	150

\* IVA ESCLUSA / \* VAT EXCLUDED

\* IVA ESCLUSA / \* VAT EXCLUDED

CODICE/CODE	PREZZO/PRICE €*	PAG.
62.00612.41	€ 286,90	150
62.00616.10	€ 29,50	162
62.00619.00	€ 9,10	137
62.00620.00	€ 8,00	137
62.00621.00	€ 28,20	136
62.00624.00	€ 66,50	136
62.00625.00	€ 43,80	136
62.00626.00	€ 73,70	136
62.00627.00	€ 73,10	136
62.00628.00	€ 61,50	88
62.00628.10	€ 85,70	88
62.00628.20	€ 85,70	88
62.00629.00	€ 61,50	88
62.00632.00	€ 3,80	164
62.00643.00	€ 145,90	63
62.00643.01	€ 145,90	63
62.00643.02	€ 145,90	63
62.00644.00	€ 200,50	34
62.00644.01	€ 200,50	34
62.00644.05	€ 200,50	34
62.00644.10	€ 220,20	34
62.00644.11	€ 220,20	34
62.00644.30	€ 220,20	34
62.00652.00	€ 179,20	37
62.00652.01	€ 179,20	37
62.00652.03	€ 179,20	37
62.00652.10	€ 199,40	37
62.00652.11	€ 199,40	37
62.00652.30	€ 199,40	37
62.00669.00	€ 1.771,50	124
62.00670.00	€ 1.771,50	124
62.00671.00	€ 2.329,10	124
62.00672.00	€ 2.526,00	124
62.00677.00	€ 1.076,70	125
62.00679.00	€ 1.846,30	125
62.00680.00	€ 2.153,30	125
62.00683.00	€ 3.860,20	125
62.00684.00	€ 4.005,70	125
62.00685.00	€ 1.869,50	126
62.00686.00	€ 2.173,50	126
62.00687.00	€ 2.761,30	126
62.00688.00	€ 3.128,00	126
62.00689.00	€ 1.059,50	126
62.00690.00	€ 1.129,20	126
62.00691.00	€ 1.940,20	126
62.00692.00	€ 2.260,40	126
62.00693.00	€ 654,50	124
62.00694.00	€ 1.501,90	124
62.00695.00	€ 1.501,90	124
62.00696.00	€ 1.981,60	124
62.00697.00	€ 2.177,60	124
62.00699.00	€ 1.039,00	118
62.00699.01	€ 904,90	118
62.00700.00	€ 1.186,40	119
62.00700.01	€ 1.020,50	119
62.00701.00	€ 770,60	117
62.00702.00	€ 1.001,90	125
62.00706.00	€ 33,60	135
62.00707.00	€ 28,20	135
62.00709.00	€ 45,60	135
62.00710.00	€ 53,40	135

\* IVA ESCLUSA / \* VAT EXCLUDED

CODICE/CODE	PREZZO/PRICE €*	PAG.
62.00711.00	€ 7,90	135
62.00712.00	€ 19,70	135
62.00713.00	€ 29,00	135
62.00714.00	€ 41,70	135
62.00722.00	€ 97,80	141
62.00722.01	€ 97,80	141
62.00722.02	€ 103,50	141
62.00722.03	€ 103,50	141
62.00722.04	€ 184,30	141
62.00722.05	€ 205,60	141
62.00723.00	€ 132,00	141
62.00723.01	€ 81,10	141
62.00723.02	€ 167,20	141
62.00723.03	€ 84,40	141
62.00723.04	€ 79,60	141
62.00723.05	€ 84,40	141
62.00724.00	€ 140,00	142
62.00724.01	€ 79,40	142
62.00724.02	€ 79,40	142
62.00724.03	€ 73,70	142
62.00724.04	€ 73,70	142
62.00725.00	€ 90,00	165
62.00741.00	€ 135,20	89
62.00741.10	€ 155,30	89
62.00741.20	€ 155,30	89
62.00742.00	€ 135,20	89
62.00743.00	€ 70,20	89
62.00744.00	€ 199,40	37
62.00744.01	€ 199,40	37
62.00744.02	€ 199,40	37
62.00744.03	€ 199,40	37
62.00745.00	€ 159,60	63
62.00745.01	€ 159,60	63
62.00745.02	€ 159,60	63
62.00745.03	€ 159,60	63
62.00755.05	€ 36,50	155
62.00755.06	€ 38,60	155
62.00755.07	€ 40,80	155
62.00755.08	€ 42,90	155
62.00755.09	€ 45,00	155
62.00755.10	€ 47,20	155
62.00755.11	€ 47,40	155
62.00755.12	€ 51,60	155
62.00755.13	€ 53,80	155
62.00755.14	€ 56,00	155
62.00755.15	€ 58,30	155
62.00755.16	€ 60,40	155
62.00755.17	€ 62,60	155
62.00755.18	€ 64,60	155
62.00755.19	€ 67,00	155
62.00755.20	€ 69,20	155
62.00755.21	€ 71,20	155
62.00755.22	€ 73,50	155
62.00755.23	€ 75,60	155
62.00755.24	€ 77,90	155
62.00755.25	€ 80,10	155
62.00755.26	€ 83,00	155
62.00755.27	€ 85,90	155
62.00755.28	€ 89,00	155
62.00755.29	€ 91,80	155
62.00755.30	€ 94,70	155

\* IVA ESCLUSA / \* VAT EXCLUDED





<b>CODICE/CODE</b>	<b>PREZZO/PRICE €*</b>	<b>PAG.</b>
62.00755.31	€ 98,00	155
62.00755.32	€ 100,90	155
62.00755.33	€ 103,80	155
62.00755.34	€ 106,70	155
62.00755.35	€ 110,10	155
62.00755.36	€ 113,40	155
62.00755.37	€ 116,60	155
62.00755.38	€ 120,00	155
62.00755.39	€ 123,10	155
62.00755.40	€ 126,40	155
62.00756.00	€ 21,20	118
62.00756.00	€ 21,20	119
62.00757.00	€ 103,50	106
62.00758.07	€ 198,70	109
62.00758.08	€ 201,70	109
62.00758.09	€ 204,80	109
62.00758.10	€ 208,00	109
62.00758.11	€ 211,10	109
62.00758.12	€ 214,20	109
62.00758.13	€ 217,40	109
62.00758.14	€ 220,50	109
62.00758.15	€ 223,50	109
62.00758.16	€ 226,60	109
62.00758.17	€ 229,80	109
62.00758.18	€ 232,80	109
62.00758.19	€ 235,90	109
62.00758.20	€ 239,10	109
62.00759.05	€ 27,40	160
62.00759.06	€ 28,30	160
62.00759.07	€ 29,10	160
62.00759.08	€ 30,00	160
62.00759.09	€ 31,10	160
62.00759.10	€ 32,10	160
62.00759.11	€ 32,90	160
62.00759.12	€ 33,90	160
62.00759.13	€ 34,80	160
62.00759.14	€ 35,80	160
62.00759.15	€ 36,90	160
62.00759.16	€ 37,90	160
62.00759.17	€ 38,80	160
62.00759.18	€ 39,60	160
62.00759.19	€ 40,50	160
62.00759.20	€ 41,70	160
62.00759.21	€ 42,60	160
62.00759.22	€ 43,70	160
62.00759.23	€ 44,70	160
62.00759.24	€ 46,00	160
62.00759.25	€ 47,40	160
62.00759.26	€ 48,80	160
62.00759.27	€ 50,10	160
62.00759.28	€ 52,50	160
62.00759.29	€ 53,80	160
62.00759.30	€ 55,10	160
62.00759.31	€ 56,70	160
62.00759.32	€ 58,10	160
62.00759.33	€ 59,50	160
62.00759.34	€ 60,80	160
62.00759.35	€ 62,20	160
62.00759.36	€ 63,60	160
62.00759.37	€ 64,90	160
62.00759.38	€ 67,50	160

\* IVA ESCLUSA / \* VAT EXCLUDED

<b>CODICE/CODE</b>	<b>PREZZO/PRICE €*</b>	<b>PAG.</b>
62.00759.39	€ 68,90	160
62.00759.40	€ 70,30	160
62.00760.05	€ 27,40	161
62.00760.06	€ 28,30	161
62.00760.07	€ 29,10	161
62.00760.08	€ 30,00	161
62.00760.09	€ 31,10	161
62.00760.10	€ 32,10	161
62.00760.11	€ 32,90	161
62.00760.12	€ 33,90	161
62.00760.13	€ 34,80	161
62.00760.14	€ 35,80	161
62.00760.15	€ 36,90	161
62.00760.16	€ 37,90	161
62.00760.17	€ 38,80	161
62.00760.18	€ 39,70	161
62.00760.19	€ 40,50	161
62.00760.20	€ 41,60	161
62.00760.21	€ 42,70	161
62.00760.22	€ 43,60	161
62.00760.23	€ 44,80	161
62.00760.24	€ 45,80	161
62.00760.25	€ 47,10	161
62.00760.26	€ 48,30	161
62.00760.27	€ 49,40	161
62.00760.28	€ 50,50	161
62.00760.29	€ 51,70	161
62.00760.30	€ 52,90	161
62.00760.31	€ 54,00	161
62.00760.32	€ 55,10	161
62.00760.33	€ 56,50	161
62.00760.34	€ 57,70	161
62.00760.35	€ 58,80	161
62.00760.36	€ 60,00	161
62.00760.37	€ 61,10	161
62.00760.38	€ 62,30	161
62.00760.39	€ 63,50	161
62.00760.40	€ 64,60	161
62.00764.00	€ 18,10	155
62.00765.00	€ 18,10	155
62.00768.00	€ 24,50	170
62.00769.00	€ 31,60	170
62.00771.00	€ 26,50	136
62.00772.00	€ 136,60	64
62.00772.01	€ 136,60	64
62.00772.02	€ 136,60	64
62.00773.00	€ 169,40	46
62.00773.01	€ 169,40	46
62.00773.02	€ 169,40	46
62.00773.03	€ 169,40	46
62.00773.04	€ 169,40	46
62.00773.05	€ 169,40	46
62.00773.06	€ 169,40	46
62.00773.07	€ 169,40	46
62.00776.00	€ 363,60	114
62.00778.00	€ 108,20	53
62.00778.01	€ 108,20	53
62.00779.00	€ 124,00	54
62.00779.01	€ 124,00	54
62.00780.00	€ 124,00	54
62.00780.01	€ 124,00	54

\* IVA ESCLUSA / \* VAT EXCLUDED

CODICE/CODE	PREZZO/PRICE €*	PAG.
62.00782.00	€ 2,20	171
62.00782.01	€ 2,20	171
62.00782.02	€ 2,20	171
62.00783.00	€ 23,40	171
62.00783.01	€ 24,40	171
62.00784.00	€ 39,00	140
62.00784.01	€ 41,10	140
62.00784.02	€ 41,10	140
62.00784.03	€ 41,10	140
62.00784.04	€ 41,10	140
62.00784.05	€ 41,10	140
62.00785.00	€ 161,30	45
62.00785.01	€ 161,30	45
62.00785.02	€ 161,30	45
62.00785.03	€ 161,30	45
62.00785.04	€ 161,30	45
62.00785.05	€ 161,30	45
62.00785.06	€ 161,30	45
62.00785.07	€ 161,30	45
62.00786.00	€ 405,80	96
62.00787.00	€ 426,60	96
62.00788.00	€ 291,40	96
62.00792.00	€ 61,50	93
62.00793.00	€ 114,70	93
62.00795.00	€ 70,40	93
62.00796.00	€ 114,70	93
62.00797.00	€ 135,20	94
62.00798.00	€ 74,50	95
62.00799.00	€ 65,40	95
62.00800.00	€ 19,20	111
62.00800.01	€ 29,70	111
62.00800.02	€ 29,70	111
62.00800.03	€ 179,00	111
62.00800.04	€ 14,80	111
62.00800.10	€ 19,20	111
62.00800.11	€ 29,70	111
62.00800.12	€ 29,70	111
62.00800.14	€ 14,80	111
62.00801.00	€ 10,70	111
62.00801.10	€ 10,70	111
62.00802.00	€ 19,20	111
62.00802.03	€ 179,00	111
62.00802.04	€ 14,80	111
62.00802.10	€ 19,20	111
62.00802.14	€ 14,80	111
62.00838.00	€ 71,30	142
62.00838.01	€ 74,10	142
62.00838.02	€ 74,10	142

CODICE/CODE	PREZZO/PRICE €*	PAG.
62.00839.00	€ 64,50	143
62.00839.01	€ 70,00	143
62.00839.02	€ 70,00	143
62.00839.03	€ 64,50	143
62.00839.04	€ 134,70	143
62.00839.05	€ 73,20	143
62.00840.00	€ 111,10	143
62.00840.01	€ 117,80	143
62.00840.02	€ 117,80	143
62.00840.03	€ 111,10	143
62.00840.04	€ 137,30	143
62.00842.00	€ 86,90	95
62.00844.00	€ 424,20	116
62.00844.00	€ 424,20	117
62.00844.00	€ 424,20	122
62.00846.00	€ 267,70	116
62.00847.00	€ 424,20	117
62.00848.00	€ 272,70	122
62.00849.00	€ 383,80	123
62.00850.00	€ 737,30	116
62.00850.01	€ 656,50	116
62.00851.00	€ 878,70	117
62.00851.01	€ 797,90	117
62.00852.00	€ 727,20	122
62.00852.01	€ 646,40	122
62.00853.00	€ 797,90	123
62.00853.01	€ 717,10	123
62.00854.00	€ 265,60	41
62.00856.00	€ 322,80	29
62.00856.10	€ 322,80	29
62.00857.00	€ 360,10	29
62.00858.00	€ 289,00	29
62.00859.00	€ 314,60	29
62.00863.00	€ 51,00	140
62.00863.01	€ 51,00	140
62.00863.02	€ 51,00	140
62.00864.00	€ 6,90	164
62.00900.00	€ 28,80	83
62.00900.01	€ 58,70	83
62.00900.02	€ 58,70	83
62.00900.03	€ 58,70	83
62.00901.00	€ 37,10	85
62.00901.01	€ 70,00	85
62.00901.02	€ 70,00	85
62.00901.03	€ 70,00	85
62.00902.00	€ 28,80	86
62.00902.01	€ 58,70	86

\* IVA ESCLUSA / \* VAT EXCLUDED

\* IVA ESCLUSA / \* VAT EXCLUDED

RIVIERA SRL GENOVA DECLINA OGNI RESPONSABILITA' PER EVENTUALI INESATTEZZE CONTENUTE NEL PRESENTE CATALOGO E DOVUTE AD ERRORI DI STAMPA E SI RISERVA ALTRESI' IL DIRITTO D'APPORTARE IN QUALUNQUE MOMENTO TUTTE QUELLE MODIFICHE CHE SI RENDERANNO NECESSARIE AI PROPRI PRODOTTI A SCOPI MIGLIORATIVI.

RIVIERA SRL GENOVA DECLINES ANY LIABILITY FOR POSSIBLE MISTAKES IN THIS CATALOGUE DUE TO PRINTING ERRORS. RIVIERA SRL GENOVA RESERVES THE RIGHT TO MAKE THOSE MODIFICATIONS THAT ARE CONSIDERED TO BE SUITABLE FOR ITS PRODUCTS.

CODES - PRICE - PAGE



## ORDINI / ORDERS

Al fine di evitare disguidi nell'esecuzione degli ordini si prega di indicare sempre:

### 1. CODICE ARTICOLO - 2. DESCRIZIONE ARTICOLO

In caso contrario non assumiamo alcuna responsabilità per eventuali errori d'interpretazione derivanti da indicazioni insufficienti.

Gli ordini pervenuti a mezzo agenti e rappresentanti, o trasmessoci direttamente, verranno immediatamente confermati, tale conferma vale come accettazione se nulla riceveremo entro il termine di 5 giorni.

Per ordini che non raggiungono l'importo minimo di Euro 150,00 al netto verranno addebitate Euro 13,00 per spese di fatturazione.

Le quantità di ordini a saldo, verranno spedite appena possibile, od unitamente ad un nuovo ordine per importi non inferiori a Euro 150,00.

*In order to avoid misunderstanding, please write your orders specifying:*

### 1. THE ARTICLE P/N - 2. THE ARTICLE DESCRIPTION

*Otherwise, we do not take any responsibility for possible interpretation mistakes which are derived from insufficient information.*

*The orders sent by agents or directly, will be confirmed to the customer and considered accepted in case we should not receive reply within 5 days.*

*We cannot accept orders for less than Euro 150,00 net. For orders with a lower amount we have to apply a special invoice charge of Euro 13,00.*

*Possible balance quantities will be sent as soon as possible or together with a new order, provided that the total amount is at least Euro 150,00.*

## SPEDIZIONI / DELIVERY

Le merci sono sempre vendute franco nostro magazzino di Genova. La merce viaggia sempre a rischio e pericolo del committente anche se spedita in porto franco. Le perdite totali o parziali delle merci durante il viaggio, avarie subite, contestazioni e ritardi della resa, non daranno diritto al committente di ritardare il pagamento stabilito o di respingere le eventuali ricevute bancarie presentate per l'incasso.

Le spedizioni verranno inoltre effettuate nei quantitativi minimi di confezione.

*The goods are always sold ex-works Genoa. Goods are despatched at buyer's risk even if sent on DDP basis (transport costs prepaid).*

*Total or partial loss of the goods during the shipment, possible damage, contestation and delay in delivery, will not give any right to the buyer to delay the agreed payment or to reject relevant drafts. The delivery will be effected in least possible quantity packages.*

## PREZZI / PRICES

Secondo il listino in vigore al momento dell'ordine.

Non sono impegnativi e possono subire variazioni fino al momento della spedizione. Si intendono IVA esclusa.

*Depending on the price list valid when placing the order.*

*The prices are non binding and are subject to possible change until the delivery. Prices do not include VAT.*

## MERCE RESA / RETURNS

Non si accettano reclami trascorsi otto giorni dal ricevimento della merce.

Non si accettano resi se non preventivamente autorizzati a mezzo scritto; qualora si riceva un reso non autorizzato siamo liberi di respingerlo.

Non si accettano resi se non in porto franco, qualora venga autorizzato un reso in porto assegnato si deve utilizzare il corriere da noi indicato.

Sulla bolla di reso è necessario indicare il numero e la data della fattura di acquisto.

La merce resa da noi autorizzata non verrà rimborsata, ma sostituita con altra di uguale valore. Tutte le spese di immagazzinaggio saranno addebitate.

*We do not accept complaints after 8 days from goods receipt.*

*We do not accept returns if not previously authorized in written, so should we receive an unauthorized return, we are free to reject it.*

*We do not accept return unless on DDP basis, and in case we authorize a return with delivery at our charge, you have to send it via the shipping agent we suggest.*

*On relevant delivery note it is necessary to show the number and the date of purchase invoice.*

*The return goods which we authorize will be not refunded, but they will be replaced with another good of same value.*

*All stock expenses will be at your charge.*

## PAGAMENTI E SCONTI / PAYMENT AND DISCOUNT

Ordini inferiori a Euro 100,00 e prima fornitura in contrassegno. Le condizioni di pagamento vanno concordate con l'agente di zona o con la direzione della ditta Riviera che si riserva di variare le suddette condizioni e gli sconti pattuiti qualora si verificassero eventi che non permettano di continuare la politica concordata con il cliente.

Per ogni R.B. saranno addebitate Euro 3,62 per spese d'incasso. La R.B. respinta annulla eventuali ordini in corso.

Trascorso il termine stabilito per il pagamento decorreranno gli interessi commerciali.

*Orders for less than Euro 100,00 and first orders on cash on delivery terms. The payment condition will have to be agreed upon with the area agent or with the Riviera sales management. They have the right to change a.m. conditions and discounts, if the politics agreed upon with the customer cannot be carried on, due to particular reasons. For any draft we will charge you Euro 3,62 for collection expenses.*

*An unaccepted draft cancels possible running orders.*

*On expiry of payment terms, trade interests will have to be applied.*

## GARANZIA / GUARANTEE

La Riviera s.r.l. Genova garantisce che i propri prodotti sono costruiti a regola d'arte e che sono privi di difetti di fabbricazione e di materiali.

**Non sono comprese nella garanzia:**

Avarie e rotture causate dal trasporto. Avarie e rotture causate da errata installazione o uso improprio. La garanzia non comprende in ogni caso l'integrale sostituzione del prodotto. La garanzia non comprende la manodopera necessaria alla sostituzione dei materiali, trasferte o trasporti.

*Riviera s.r.l. Genova guarantees its products to be free from defects of workmanship or materials.*

**This guarantee does not cover:**

*Damages and breakage during the transport. Damages and breakage due to faulty installation or improper use. Guarantee does not include neither the complete replacement of the goods, nor the necessary labour for goods replacement, transfer or transport.*

## IMPORTANTE / IMPORTANT

Le caratteristiche tecniche ed estetiche degli articoli in visione sul nostro catalogo, sono indicative e possono variare in qualsiasi momento.

La Riviera s.r.l. Genova, declina ogni responsabilità per possibili inesattezze contenute nel presente catalogo, dovute ad eventuali errori di stampa o trascrizioni; si riserva il diritto di apporre ai propri articoli quelle modifiche che riterrà necessarie od utili senza pregiudicarne le caratteristiche essenziali.

*The technical and apparent characteristics of the products shown on our catalogue are approximate and may change at any moment.*

*Riviera s.r.l. Genova decline all responsibility for possible inaccuracy in this text, due to possible misprints or clerical errors and reserve the right to introduce any changes in the text if considered useful or necessary, without compromising the main feature of the articles*

## FORO COMPETENTE / CONTESTATION

Per ogni controversia sarà competente il Foro di Genova – Italia.

I diritti di pubblicazione del presente catalogo sono riservati alla ditta Riviera s.r.l. Genova. Tutte le riproduzioni anche parziali sono vietate.

*For any contestation place of jurisdiction is Genova - Italy. Riviera s.r.l. Genova have the copyright of this catalogue. No reproduction, even if partial, is allowed.*





---

**Riviera srl Genova**

Via Inferiore Rio Maggiore, 4A - 16138 Genova - Italy

Tel. + 39 010 8355286 - Fax: + 39 010 8356309

Skype: riviera-marketing

E-mail: [info@rivieragenova.it](mailto:info@rivieragenova.it) - Site: [www.rivieragenova.com](http://www.rivieragenova.com)