



MECANOREM
REMORQUES

PIÈCES DÉTACHÉES

NAUTISME | PORTUAIRE | UTILITAIRE





As a French manufacturer of trailers of all types for over 40 years, MECANOREM is today one of the major players in the market.

Bringing together 40 people and extending over more than 8000 m², the company uses its know-how and skills in 4 main sectors.

- › Boat trailers (sail or motor)
- › Port equipment (hydraulic trucks, storage cradles, etc)
- › Utility trailers (tippers, flatbeds, parks & gardens, etc)
- › Special trailers (tailor-made, from plans)

Based in **Valognes (50)**, MECANOREM has a technical centre at **Gignac-la-Nerthe (13)**, north of Marseille. To be

even closer to its customers, MECANOREM has a network of more than 1000 retailers in France and abroad.

MECANOREM trailers are approved according to the latest European manufacturing standards, 2007/46/EC.

These trailers are in particular equipped with:

- › A hot-dip galvanised frame and axle structure
- › Suspension with rubber components
- › A removable signalling plate for launching
- › An ALKO braking system with automatic reverse

MECANOREM is an approved member of SYFAMER (National Union of Manufacturers of Pleasure Boating Equipment).

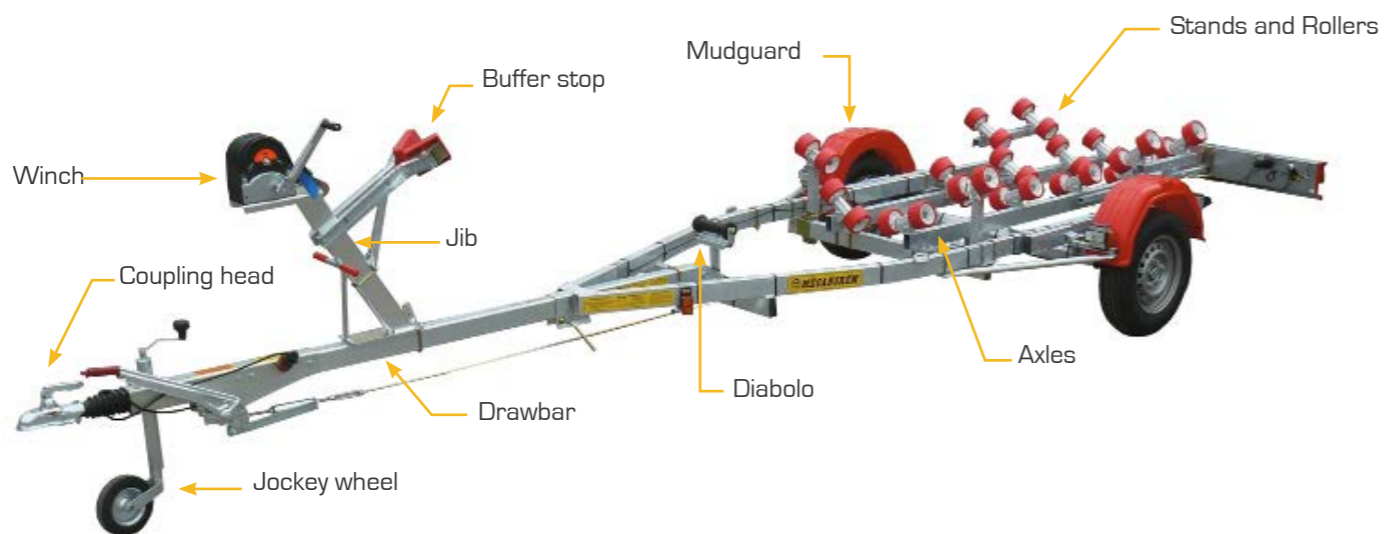

You can find all our TECHNICAL ADVICE as well as our CONDITIONS OF SALE on our website

www.mecanorem.com



- CONTENTS -

ACCESSORIES	04 / 28
WINCHES	06
LIGHTING	06
SAILING	10
JOCKEY WHEELS	18
HITCHING	20
WHEELS	22
HYDRAULIC	26
AXLES	30
ORDER FORM	35
INDEX	38

› MULTI-FUNCTION LIGHTS

| 7 and 8 LED functions
Dimensions: 181 x 141 x 35 mm
Weight: 400 g
Attachment centre distance: 150 mm
Connectors: see photo
T-04370 8 Functions - Right
T-04371 7 Functions - Left



| 7 LED functions
Dimensions: 243 x 148 x 48 mm
Weight: 500 g
Attachment centre distance: 152 mm
48 LEDs 12V - 4W with cable
T-04240



- 7 & 8 FUNCTIONS -



| Light 7 functions
Dimensions: 215 x 140 x 52 mm
Weight: 470 g
Attachment centre distance: 150 mm
Bulbs:
2 x 12V 21W (T-04011)
1 x 12V 21W (T-04002)
1 x 12V 5W (T-04013)

T-04380D Right
T-04380G Left



| Light 7 functions AJBA
Dimensions: 187 x 130 x 50 mm
Weight: 340 g
Attachment centre distance: 150 mm
Connectors: 5 pins / 4 pins
Bulbs:
3 x 12V 21W (T-04002)
1 x 12V 10W (T-04003)

T-04350D Right
T-04350G Left



| Light 7 functions
Dimensions: 235 x 135 x 53 mm
Weight: 435 g
Attachment centre distance: 150 mm - screw Ø 6
Bulbs:
2 x 12V 21W (T-04002)
1 x 12V 5W (T-04012)
1 x 12V 21/5W (T-04014)

T-04340D Right - 4 functions
T-04340G Left - 7 functions



| Light 7 functions
Dimensions: 270 x 150 x 60 mm
Weight: 470 g
Attachment centre distance: 150 mm
Bulbs:
2 x 12V 21W (T-04011)
1 x 12V 21W (T-04012)
1 x 12V 5W (T-04013)

T-04271D Right - 4 functions
T-04271G Left - 7 functions

- 5 & 7 FUNCTIONS -



| Light 5 functions oval
Dimensions: 286 x 139 x 60 mm
Weight: 600 g
Attachment centre distance: 120 mm

T-04380D Right
T-04380G Left



| Rectangular light 5 functions AJBA
Dimensions: 190 x 93 x 55 mm
Weight: 290 g
Attachment centre distance: 57 mm
Bulbs:
2 x 12V 21W (T-04002)
1 x 12V 21/5W (T-04014)

T-04350D Right
T-04350G Left



| Rectangular light 5 functions PROMOT
Dimensions: 200 x 100 x 55 mm
Weight: 290 g
Attachment centre distance: 55 mm
Bulbs:
2 x 12V 21W (T-04002)
1 x 12V 21/5W (T-04014)

T-04340D Right - 4 functions
T-04340G Left - 7 functions



| Light 5 functions
Dimensions: 220 x 140 x 60 mm
Weight: 400 g
Attachment centre distance: 70 mm
Attachment: 6.5 mm
Bulbs:
3 x 12V 21W (T-04002)
1 x 12V 21/5W (T-04014)

T-04026 Left
T-04025 Right



| Light 5 functions
Dimensions: 240 x 140 x 52 mm
Weight: 600 g
Attachment centre distance: 150 mm
Connectors: 5 pins
Bulbs:
2 x 12V 21W (T-04002)
1 x 12V 21/5W (T-04014)

T-04095 Right
T-04096 Left



| Rectangular light 5 functions CEE
Dimensions: 188 x 100 x 54 mm
Weight: 300 g
Attachment centre distance: 90 mm
Bulbs:
2 x 12V 21W (T-04002)
1 x 12V 21/5W (T-04014)

T-04027D Left with reversing light



| Light 4 functions mounted Series P
Dimensions: 105 x 100 x 52 mm
Weight: 130 g
Attachment centre distance: 45 mm
Bulbs:
2 x 12V 21/5W (T-04014)

T-04032

Supplied with bulb

Supplied without bulb

› POSITION LIGHTS



| White rectangle position light
Dim. : 96 x 47 x 25 mm
Attachment centre distance: 75 mm

T-04034



| White square position light
Dim. : 63 x 67 x 43 mm
Attachment centre distance: 30mm

T-04035



| LED white position light
Dim. : 96 x 31 x 10 mm
Attachment centre distance: 70 mm

T-04373



| LED position light
Dim. :
Attachment centre distance:

T-04241

› MARKER LIGHTS



| Two-colour marker light
Dim. : 75 x 40 x 25 mm
Attachment centre distance: 30mm
Bulb:
1 x 12V 5W (T-04013)

T-04035

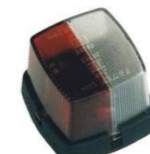

| Two-colour marker light
Dim. : 60 x 55 x 40 mm
Attachment centre distance: 30mm
Bulb:
1 x 12V 5W (T-04013)

T-04055



| LED marker light
Dim. : 50 x 27 x 25 mm
Attachment: Ø 18 mm

T-04374

› OTHER LIGHTS

- FOG LIGHTS -



| Fog light series P
Dim. : 80 x 70 x 55 mm
Attachment centre distance: 55 mm
Bulb:
12V 21 W (T-04011)

T-04066



| Fog light Jokon
Dim. : 121 x 88 x 48 mm
Attachment centre distance: 30mm
Bulb:
2V 21 W (T-04011)

T-04065

- NUMBER PLATE LIGHTS -



| Number plate light
Dim. : 80 x 70 x 55 mm
Attachment centre distance: 55 mm
Bulb:
12V 21 W (T-04011)

T-04260



| LED number plate light
Dim. : 121 x 88 x 48 mm
Attachment centre distance: 30mm
Bulb:
2V 21 W (T-04011)

T-04375

- FLASHING LIGHTS -



| LED flashing light 12/24V
Attachment: by 3 points
Ø 122 - H. : 140 mm

T-71540



| Yellow flashing light
Attachment: by 3 points
Ø 140 - H. : 190 mm
T-04098 Flashing light 12V
T-04097 Flashing light 24V



| Adhesive rectangular
Dim. : 57 x 39 mm
T-04039 Orange



| Triangle approved
Height: 138 mm
Centre distance: 70 mm
T-04040



| Round adhesive
Dim. : Ø 54 mm
T-04036 White
T-04037 Orange
T-04038 Red



| Socket outlet
T-35251

› BULBS

Sold by box of 10



| Grease nipple yellow 12V - 21W
T-04002



| Grease nipple 12V - 21W
T-04011



| Grease nipple 12V - 5W
T-04003
12V - 10W



| Festoon bulb 12V - 5W
T-04013



| Stop bulb 12V - 21/5W
T-04014

> LIGHTING RAILS

- LIGHTING RAIL -



T-03001 Cable 7m Width 1.35m
T-03004 Cable 7m Width 1.50m

- LIGHTING RAIL NAVICA -



T-03008CE Width 1.85m + reversing light

- LIGHTING RAIL COMPLETE -



T-03101 1.75m Plug 13 pins + reversing light
T-03102 1.95m Plug 13 pins + reversing light
T-03103 2.15m Plug 13 pins + reversing light

- LIGHTING RAIL COMPLETE - RADEX



T-03010CE 1.75m Plug 13 pins + reversing light
T-03011CE 1.95m Plug 13 pins + reversing light
T-03012CE 2.15m Plug 13 pins + reversing light

> CABLES AND HARNESSSES

- ELECTRIC CABLES -



Flexible multiconductor electric cables
Sold by the linear metre

T-03054 Wire 2 x 1 mm
T-03058 Wire 7 x 1 mm
T-03061 Wire 8 x 1 mm

- LED LIGHT CHAIN CABLES -



2-wire chain cables for LED lights

T-04390 Length 0.3 m

- HARNESSSES WITH SPLICES -



Harnesses with splices
The plugs are included with the harnesses

T-03050 Length 8.5 m
T-03050CE Length 8.5 m
T-03051 Length 10 m
T-03051CE Length 10 m
T-04260 Length 3 m
T-04260CE Length 3 m

- LED LIGHT CONNECTOR CABLES -



2-wire and 8-wire connecting cables for LED lights

T-04385 2 wires Length 1 m
T-04386 2 wires Length 2 m
T-04388 2 wires Length 3 m
T-04389 2 wires Length 4 m

- POWER CABLES - LED LIGHTS



2-wire and 8-wire connecting cables for LED lights

T-04381 5 metres Plug 13 pins
T-04395 2 metres Socket 13 poles

> CONNECTION / LINKAGE

- CONNECTION SOCKETS -



| Male plug 13 pins plastic
T-04010



| Male plug 7 pins
T-04015 Plastic body
T-04016 Metal body



| Male plug 7 pins 24V
T-04017 Plastic body
T-04049 Metal body



| Male plug 6+7 plastic pins
T-04043

- ADAPTORS -



| Adaptor 13-7 pins
For vehicle 7 pins
Plastic body
Male plug 7 pins
Female plug 13 pins
T-04024



| Adaptor 7-13 pins
For vehicle 13 pins
Plastic body
Male plug 13 pins
Female plug 7 pins
T-04069



| Adaptor plug 24/12 V
7 poles
12 Volts
T-04711



| Coupling socket
Female plug
7 pins
12V
T-04710

- PLUG-IN SOCKET -



| Female socket 7 pins
T-04020 Plastic body
T-04021 Metal body



| Female socket
T-04030 13 pins
T-04031 6 + 7 pins



| Connection box 3 + 8
T-04377



| Battery 12V
T-70502 Battery 70 AH
T-70517 Battery 100 AH
T-70521 Battery 120 AH



| Electrical connection
Fenwick socket
Sold in pairs
T-32604

- BATTERIES -

> MISCELLANEOUS



| Light extension
Round tube Ø27
Length 1 m
T-03063



| Support attachment for light rail
T-04261



| Light plate spring
Monoblock
T-04258



| Light plate end cap
Right or Left
For MB1/MB2/MB3
T-04257 Red
T-04104 1.35 / 1.50



| Fixing lug LED lights
T-04376



| Wing nut
Diameter Ø 8mm
Sold in 10s
T-03080



| Ski support fitting
T-03078



| Ski tube Navica
30 x 30 mm
Length 1 m
T-03064



| Ski tube
30 x 30 mm
Length 1.2 m
T-03073



| Ski attachment
Height: 80 mm
T-03070



| Beta pin
Sold in 10s
T-03083 Ø 3 mm
T-03086 Ø 4 mm



| Grenade pin
Sold in 10s
T-03089 Ø 4.5 mm
T-03088 Ø 6 mm



| Locking screw
M14
T-03092 With ring
T-03095 In L
T-03098 In L NAVICA



| Tightening handle
T-03096 M12
T-03097 M14

› RUBBER ITEMS

– ROLLERS –



| Twin-material roller
 Ø 100 mm - L: 50 mm
 Bore: Ø 21 mm
T-06101 Red
T-06102 Yellow
T-06103 Turquoise
T-06104 Black
 Bore: Ø 17 mm
T-06105 Black Jeantet



| Roller 185 Polyamide
 Twin-material red
 Ø 120 mm - L: 75 mm
 Bore Ø 21 mm
T-06185 Red
T-06186 Black
T-06187 Yellow

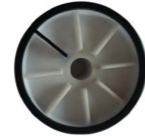

| Roller 120 JEANTET
 Bore Ø 21 mm
T-06106 Black
T-06107 Black reinforced



| Roller SM
 Ø 75 mm - L: 75 mm
 Bore Ø 17 mm
T-06070
 Bore Ø 21 mm
T-06071



| Roller LG
 Ø 120 mm - L: 75 mm
 Bore Ø 17 mm
T-06080
 Bore Ø 21 mm
T-06081



| Roller PRO 100 ring
 Ø 140 mm - L: 80 mm
 Bore Ø 21 mm
T-06100



| Roller 082 RB Reinforced
 Ø 120 mm - L: 80 mm
 Mounted on nylon rings
 Bore Ø 21 mm
T-06082



| Centring roller
 Ø 90 mm - Ø 115 mm
 L: 80 mm
 Bore Ø 21 mm
T-06115

– DIABOLOS –



| Diabolo Mini 030
 130 x Ø 70 - 40
T-06030 Bore Ø 17 mm
T-06031 Bore Ø 21 mm



| Diabolo LG 040
 200 x Ø 75 - 50
 Bore Ø 17 mm
T-06040 Black
 Bore Ø 21 mm
T-06041 Black (485g)
T-06042 Red (380g)



| Diabolo Super 060
 200 x Ø 85 - 60
 Bore Ø 21 mm
T-06060



| Diabolo Super 060
 With tube inside
 200 x Ø 85 - 60
 Bore Ø 21 mm
T-06061A



| Diabolo PN 050
 200 x Ø 70 - 60
 Bore Ø 17 mm
T-06050
 Bore Ø 21 mm
T-06051 Black (730g)
T-06052 Red (585g)

– SKIDS –



| Skid SM 010
 L: 130 mm
 W: 100 mm
 Bore: 1 x Ø 11 mm
T-07110 Black
T-07111 Red
T-07112 Yellow
T-07113 Turquoise

| Skid LG 020
 L: 300 mm - W: 100 mm
 Ht: 30mm
 Bore: 2 x Ø 11 mm
T-07120 Black
T-07121 Red
T-07122 Yellow
T-07123 Turquoise



| Skid LG 030
 L: 300 mm - W: 100 mm - Ht: 20 mm
 Bore: 2 x Ø 11 mm
T-07130 Black
T-07131 Red

› RUBBER ITEMS

– MISCELLANEOUS –



| Cone PN
In red plastic
Ø 180 mm x 55 mm
Bore Ø 21 mm
T-06190



| Bow buffer stop
L: 160 mm - W: 55 mm
Attachment by 2 screws M10
T-07200



| Red plastic handle
T-07053 Ø 8
T-07054 Ø 10
T-07055 Ø 12
T-07056 Ø 17
T-07057 Ø 21
T-07058 Ø 25
T-07059 Ø 27
T-07060 Ø 34



| Tube end pieces
T-07045 25 x 25
T-07041 30 x 30
T-07042 40 x 40
T-07046 40 x 27
T-07047 50 x 30
T-07043 50 x 50
T-07048 60 x 30
T-07049 80 x 40
T-07050 100 x 50
T-07051 120 x 60



| Profile 3010
L: per metre
W: 30 x 10 mm
T-07040



| Profile 9035
W: 90 x 35 mm
T-07035 L: 600 mm
T-07036 L: 750 mm
T-07037 L: 450 mm

| Yellow plastic handle
T-07061 Ø 21

| Turquoise plastic handle
T-07062 Ø 21

› RUBBER SETS

– DIABOLO SETS –



| Diabolo mini 030
Dimensions:
170 x 70 x 90 mm
T-09030



| Diabolo LG 040
Dimensions:
250 x 95 mm
T-09040 Black
T-09039 Red



| Diabolo PN 050
Dimensions:
250 x 70 x 90 mm
T-09050 Black
T-09051 Red



| Diabolo Super
Dimensions:
250 x 85 x 100 mm
T-09060



| Diabolo Super 060
With tube inside
Dimensions:
250 x 85 x 100 mm
T-09061

– SKID SETS –



| Skid SM 130 x 100
Skid support SM
T-10010 Red
T-10011 Yellow
T-10012 Turquoise
T-10013 Black



| Skid LG 300 x 100
Skid support LG
T-10020 For stand 30 x 30
T-10021 For stand 50 x 50



| 2 Skids LG 300 x 100
Double LG skid support
T-10022 Red
T-10022N Black
T-10028 Yellow



| 2 Skids LG 300 x 100
Skid support LG
T-10023 Red

› RUBBER SETS

– SKID SETS –



| Triple LG skid support
3 skids LG 300 x 100
T-10025 Red
T-10025N Black



| Quadruple LG skid support
4 skids LG 300 x 100
T-10024 Red
T-10024N Black

– ROLLER SETS –



| 2 rollers 100 bi-material Ø 100
Mounted on rocker arm SM 30 x 30
Tube: 30 x 30 mm
Dimensions: 215 x 100 mm
T-09887 Red
T-09888 Yellow
T-09889 Turquoise



| 2 rollers 100 bi-material Ø 100
Mounted on rocker arm LG 40 x 40
Tube 40 x 40 mm
Dimensions: 215 x 100 mm
T-09286 Red
T-09286N Black
T-09287 Yellow
T-09288 Turquoise
T-09290N Black Jeantet



| 2 rollers 185 bi-material Ø120
Mounted on rocker arm LG 40 x 40
Tube: 40 x 40 mm
Dimensions: 205 x 115 mm
T-09285 Red
T-09285N Black
T-09289 Yellow
T-09291N Black Jeantet



| Set 2 rollers MTX
Mounted on rocker arm MTX spindle Ø 20
Hollow, Tube: 40 x 40 mm
Dimensions: 255 x 120 x 140 mm
T-09387 Red Ø 100 mm
T-09387N Black Ø 100 mm
T-09388 Yellow Ø 100 mm
T-09389 Turquoise Ø 100 mm
T-09890N Black Jeantet Ø 100 mm
T-09386 Red Ø 120 mm
T-09386N Black Ø 120 mm
T-09390 Yellow Ø 120 mm
T-09891N Black Jeantet Ø 120 mm
T-09891NR Black Jeantet Reinforced Ø 120 mm



| 2 rollers SM square 30 x 30
Mounted on rocker arm SM 30 x 30
Dimensions: 200 x 70 x 95 mm
T-09070



| 2 rollers LG square 40 x 40
Mounted on rocker arm LG 40 x 40
Dimensions: 210 x 120 mm
T-09080



| 2 rollers 082 RB
Dimensions: 215 x 120 mm
Mounted on rocker arm LG 40 x 40
T-09082
Mounted on rocker arm SM 30 x 30
T-09083



| 2 rollers PRO
Mounted on rocker arm PRO (T-08010)
Dimensions: 225 x 140 mm
T-09100



| Rocker arm PN
Mounted on rocker arm LG 40 x 40
Dimensions: 310 x 180 mm
T-09190



| 4 rollers 082 RB
Dimensions: 245x280x135mm
T-09086



| 4 rollers PRO
Dimensions: 32x255x140mm
T-09114



| Diabolo kit
Made up of a spindle, a diabolo super 060 and 2 centring rollers
T-09195

See all our rocker arms and stands pages 15 and 16

› ROLLER & STAND SETS

– 2-ROLLER SETS –



| Set of 2 rollers Ø 100 bi-material
Yellow



| Set of 2 rollers Ø 100 bi-material
Blue

Reference	Stand	Length	Omega
T-10902	30x30	400mm	Without
T-10898	40x40	400mm	With
T-10881	40x40	500mm	Without
T-10897	40x40	500mm	With

Reference	Stand	Length	Omega
T-10905	30x30	350mm	With
T-10904	30x30	350mm	Without
T-10907	40x40	350mm	With
T-10906	40x40	400mm	With
T-10884	40x40	500mm	Without



| Set of 2 rollers Ø 100 bi-material
Red



| Set of 2 rollers SM
Omega 60 x 30
T-10030



| Set of 2 rollers PRO
Omega 80 x 40 or 100 x 50
T-10100

Reference	Stand	Length	Omega
T-10887	30x30	500mm	With



| Set of 2 rollers 185
bi-material Ø 120
On rocker arm LG
T-10285 Omega 80 x 40
T-10286 Omega 100 x 50



| Set of 2 rollers 082 RB
Rocker arm LG
Omega 80 x 40 or 100 x 50
T-10082



| Set of 2 rollers 185
bi-material Ø 120
On rocker arm LG
T-10286J Omega 100 x 50



| Set of 2 rollers 185
bi-material Ø 120
On rocker arm LG
T-10286N Omega 100 x 50

– 4- & 6-ROLLER SETS –



| Set 185 bi-material
T-09486 Rocker arm 30 (red)
T-09485 Rocker arm 40 (red)
T-09492 Rocker arm 40 (yellow)



| Set PRO double
T-10110 Omega 80 x 40
T-10111 Omega 100 x 50
T-10114 Omega 120 x 60



| Set 4 rollers 185
T-10085 Omega 80 x 40
T-10095 Omega 100 x 50



| Set 4 rollers 082
T-10086 Omega 80 x 40
T-10096 Omega 100 x 50
T-10097 Omega 120 x 60

› ROLLER & STAND SETS

– SETS 4 ROLLERS –



| Quadruple set on rocker arm
Turquoise
T-10912 Stand 30 x 30
T-09489 Stand 40 x 40
T-09490 Stand 40 x 40 reinforced



| Quadruple set on rocker arm
Yellow
T-10087



| Quadruple set on rocker arm
Red
T-09488 Stand 40 x 40



| Quadruple set
Turquoise; Stand 40 x 40
T-10091 With omega
T-10807 Without omega

– SETS 6 ROLLERS –



| Sextuple set
Turquoise
Sextuple fixed rocker arm LG
Navica
T-10092 With reinforced
omega
T-10810 Without omega



| Sextuple set
Yellow
Sextuple fixed rocker arm LG
Navica
T-101406 With rein-
forced omega
T-10093 Without omega



| Set Diabolo MTX
Single with diabolo 040
T-09043 Length 200 mm
T-09042 Length 250 mm
T-09044 Length 300 mm
T-09045 Length 350 mm
Single with diabolo PN 050
T-11059 Length 300 mm
T-11058 Length 350 mm



Double with diabolo 060
T-09041 For MTX
T-09041R For NX



| Set Diabolo PN
Consisting of a support, a
diabolo, an omega and flanges
T-11060 With omega
T-11061 With centring
roller

– SKID SETS –



| Adjustable nose skid support assem-
bly
T-11005



| Side skid set
With rubber, flanges and omega
T-11025



| Cross-member side skids set
Consisting of a cross-member, 2 side skids,
flanges and omegas
T-11035

– CONE SETS –



| Cone set on rocker arm
with stand
Consisting of cones, rocker arm, stand, flanges
and omega
T-11030



| Cross-member set small
Consisting of 2 sets of cones, a stand, flanges
and omega
T-11040



| Ramp set 12 cones
Consisting of a ramp and 12 cones
T-11080

› ROCKER ARMS & SUPPORTS

- ROCKER ARMS -



| Rocker arm SM
For stand 30
Spindle Ø 20 for cones
Length 290 mm
T-08006
Spindle Ø 20 for rollers
Length: 180 mm
T-08005



| Rocker arm LG
For stand 40
Spindle Ø 20 hollow LG
T-08011
Spindle Ø 17 hollow LG
T-08018
Spindle Ø 20 solid PRO
T-08010



| Rocker arm SUPER
For stand 40
Spindle Ø 20 hollow LG
T-08013
Spindle Ø 20 solid PRO
T-08012



| Rocker arm CR
Spindle Ø 20 hollow
T-08009
Spindle Ø 17 hollow
T-08017
Spindle Ø 20 solid
T-08008

- SPINDLES AND STOP WASHERS -



| Spindles in solid steel

T-08014	Diameter Ø 14	Length 170 mm
T-08016	Diameter Ø 16	Length 250 mm
T-08020	Diameter Ø 20	Length 250 mm
T-08021	Diameter Ø 20	Length 370 mm



| Hollow spindles in tube

T-08030	Diameter Ø 20	Length 170 mm
T-08031	Diameter Ø 20	Length 250 mm



| Locking washer for spindle
Sold in pack of 50

T-08214	Diameter Ø 14
T-08216	Diameter Ø 16
T-08220	Diameter Ø 20

- SKID SUPPORTS -



| Skid support SM
T-08055



| Skid support LG
For tube 30
T-08070



| Skid support LG
For tube 50
T-08075



| Skid support LG double
For tube 50
T-08080

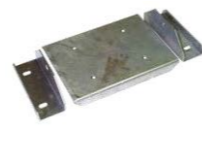

| Skid support LG
T-08085

- DIABOLO SUPPORTS -



| Diabolo support mini
Spindle Ø 20
T-08047



| Diabolo support SM or LG
Spindle Ø 20
T-08052



| Diabolo support MTX
Double for diabolo O60
Spindle Ø 20
T-08096



| Diabolo support MTX
Single for diabolo O40
Spindle Ø 20
T-08097 Length 200
T-08095 Length 250
Single for diabolo O40 or diabolo PN050
T-08098 Length 300
T-08099 Length 350

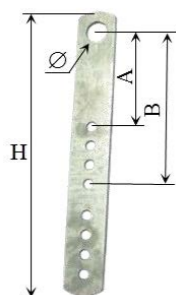

| Diabolo support fitting on chassis
Single for diabolo O40

Ref.	H	A	B	Ø	Tube
T-08101	200	55	120	21	60x30 80x40
T-08104	350	100	120	21	80x40 100x50

- UNIVERSAL JOINT -



| Universal joint for tube

T-08060	SM	For tube 50
T-08062	LG	For tube 60
T-08064	SU	For tube 70

› STANDS



Reference	Stand	Length
T-12004		300mm
T-12005		350mm
T-12006	30x30x2	400mm
T-12008		500mm
T-12010		600mm
T-12014		400mm
T-12016	40x40x2	500mm
T-12018		600mm
T-12020		700mm
T-12023		500mm
T-12024	50x50x2	600mm
T-12026		800mm
T-12028		1000mm
T-12032	50x50x3.2	1200mm
T-12034		1500mm



Reference	Tube	Length
T-12012	30x30	3000mm
T-12022	40x40	3000mm
T-12036	50x50	3000mm
T-12051	50x30	3000mm
T-12052	60x30	3000mm
T-12053	80x40	3000mm
T-12054	60x60	3000mm



| Adjustable stand
Stand 50x50
Length 500
Adjustment: 150mm
T-12100

- CHASSIS COMPONENTS ON REQUEST -

To submit your request for chassis components, please send us the serial number of your trailer
Eg: VHT _____
as well as the parts you need by email:

piecesdetachees@mecanorem.com

We will send you the reference to include on your order form.

› WINCH SET

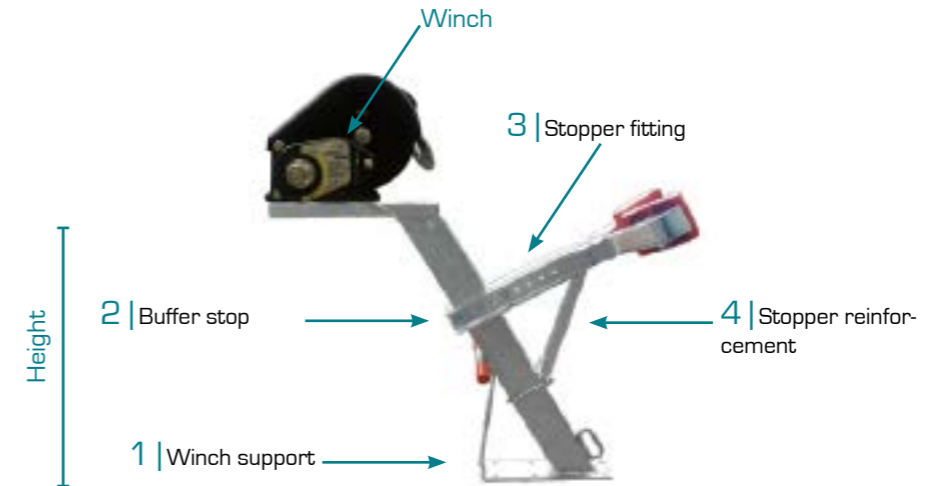

| Winch support (1)

	Reference	Section	Height
SM	T-14100	60x30	500
	T-14101	40x40	400
	T-14202	80x40	800
LG	T-14200T	80 x 40	550
	T-14301T	80 x 40	650
	T-14303	100x50	700
Super	T-14304	100x50	600
	T-14305	100x50	1000
Hyper	T-14400	120x60	800
	T-14430	120x60	900

| Buffer stop complete (2)

	Reference	Section
SM	T-14150	Red
	T-14151	Yellow
	T-14160	Red
MM	T-14161	Yellow
	T-14162	Turquoise
	T-14250	Red
LG	T-14251	Yellow
	T-14252	Black
	T-14270	Turquoise
Hyper	T-14352	Turquoise
	T-14450	Red
	T-14451	Turquoise
	T-14452	Yellow



| Stop fitting (3)

	Reference	Length
SM	T-14110	380mm
LG	T-14310	470mm
Super	T-14350	470mm
Hyper	T-14410	580mm
Extension	T-14411	550mm



| Stop fitting reinforcement (4)

	Reference	Length
SM	T-14722	230mm
LG	T-14723	300mm
Hyper	T-14724	380mm

› JOCKEY WHEELS

– JOCKEY WHEELS ON THEIR OWN –



| SM 34
Jockey wheel Ø 34
Roller 160 x 40mm
Max payload: 40 kg
Weight 2.4 kg
T-13022



| SM 42
Jockey wheel Ø42
Roller 200 x 50mm
Max payload: 65 kg
Weight 5 kg
T-13032



| SM 48
Jockey wheel Ø48
Roller 200 x 50mm
Max payload: 80 kg
Weight 5 kg
T-13042



| Super 60
Jockey wheel Ø 60
Roller 250 x 80mm
Max payload: 120 kg
Weight 9 kg
T-13062



| Hyper 70 Pull-down
Jockey wheel 70x70
Roller 250 x 80mm
Max payload: 250 kg
Weight 15 kg
T-13072



| Inflatable
Jockey wheel Ø48
Roller 260 x 85mm
Max payload: 120 kg
Weight 5 kg
T-13082

– JOCKEY WHEELS WITH COLLAR –



Reference	Jockey wheel + yoke	Weight	Collar reference	Collar
T-13020	SM 34	3 kg	T-13023	Bolt-on
T-13030	LG 42	5.4 kg	T-13033	
T-13040	LG 48	5.5 kg	T-13043	
T-13080	LG 48 Inflatable	5 kg	T-13043	
T-13050	LG 60	13 kg	T-13063	
T-13060	Super 60	10.5 kg	T-13063	
T-13070	Super 70	15.5 kg	T-13073	To weld

– COLLARS –



| Full collar with flanges
T-13024 JW SM 34 60x60
T-13035 JW LG 42 60x60
T-13044 JW LG 48 60x60



| Complete bolt-on collar
T-13023 JW SM 34
T-13033 JW LG 42
T-13063 JW LG / Super 60
T-13043 JW LG 48 - 2 holes



| Complete bolt-on collar
For JW LG 48 reinforced 4 holes
T-13049



| Support collar JW MTX
T-13412 JW LG 48 80x40
T-13405 JW LG 48 100x50
T-13067 JW LG 60 100x50
T-13068 JW LG 60 120x60

– ACCESSORIES FOR JOCKEY WHEELS –



| Tightening handle
T-13243 For JW SM 34, LG 42, LG 48
T-13363 For JW LG 60 and Super 60



| Jockey wheel spindle
T-13134



| Wheel only for JW LG 42 and LG 48
Ø ext: 200 x 50
Bore: 20
Rim: plastic / steel
Width: 30
T-13248



| Wheel only for JW LG 60 and Super 60
Ø ext: 220 x 65
Bore: 20
Rim: steel
Width: 60
T-13368



| Wheel only for Hyper 70
Ø ext: 250 x 80
Bore: 25
Rim: steel
Width: 200
T-13371



| Wheel only for JW Inflatable
Ø ext: 250 x 80
Bore: 20
Rim: plastic
Width: 90
T-29502

– PROPS –



| Prop Ø 34
Length: 550 mm
T-13010



| Prop Ø 42
Length: 550 mm
T-13015



| Prop Ø 48
Length: 550 mm
T-13016



| Cylinder support leg
1300 kg
T-13501



| Brace 23
T-13503

– GAS STRUTS AND SUPPORT LEGS

› BRAKE CONTROLS



Reference	Type	GAW	Brake type	Weight	Head
T-36501	60S/2	450 / 750 kg	1636G / 1637	9 kg	AK160
T-36502	90S/3	700 / 1000 kg	1636G / 1637 / 20	9 kg	AK160
T-36503	161S	950 / 1600kg	1637 / 2051	12 kg	AK160
T-36504			2361		AK160
T-36505	251S	1500 / 2600kg	1637 / 2051	14 kg	AK300
T-36506			2361		AK300
T-36507	2.8VB/1	2500 / 3500kg	2051 / 2361	33 kg	AK350

Brake control for square drawbars

Reference	Type	GAW	Drawbar
T-36540	60S/2	750 kg	60x60
T-36541	90S/3	1000 kg	70x70
T-36543	161S	1600kg	70x70
T-36545	2.8VB/1	3500kg	120x120

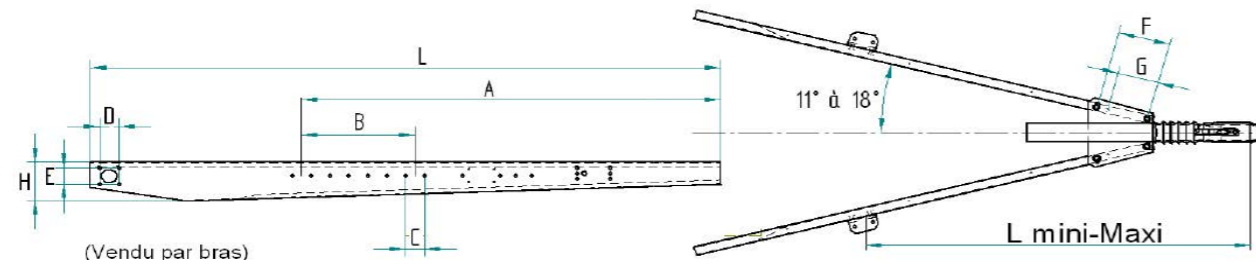

(Vendu par bras)

Approved V-shaped drawbars 94/20

Reference	Type	GAW	L	A	B	C	D	E	F	G	H	L min-max
T-21501	TV 175750	750 kg	1.75m	1110	240	60	50	40	165	130	120	970-1415
T-21502	TV 200110	1100kg	2.00m	1330	360	60	60	60	165	-	140	1275-1415
T-21503	TV 200170	1700kg	2.00m	1330	360	60	60	60	165	-	160	1275-1415
T-21504	TV 200220	2200kg	2.00m	1330	360	60	60	60	165	120	160	1275-1415
T-21505	TV 200280	2800kg	2.00m	1330	360	60	60	60	120/120	186	180	1275-1415
T-21506	TV 200350	3500kg	2.00m	1330	360	60	60	60	120/120	186	200	1275-1415



Full adjustable drawbars braked

Reference	Type	GAW	Brake	Ring 42/68	Ball attachment
T-36510	161 VB-2	1600 kg	1634 / 2051	T-36520	T-35501
T-36511			2361		
T-36512	251 VB-2	2700 kg	1637 / 2051	T-36521	T-35502
T-36513			2361		
T-36514	351 VB-2	3500 kg	2051 / 2361		T-35503



Breaking cable with ring

For brake control
60S, 90S, 161 S, 251 S, SV 3.5
T-35265 Length 900 mm
T-35269 For adjustable drawbar



Gussets

Ref.	Control type	Mass
T-35275	60S - 90S	0.12
T-35276	161S - 251S	0.20
T-35277	SV 3.5	0.23



Shock absorbers

Ref.	Control type	Mass
T-35311	60S	0.50kg
T-35312	90S	0.50kg
T-35315	161S Gen. 92	1.00kg
T-35310	251S Gen. 92	1.20kg
T-35316	SV 3.5	1.70kg



Brake lever + spindle and nut

Ref.	Control type	Mass
T-35155	60S - 90S3	2.40kg
T-35156	161S	2.20kg
T-35157	251S	2.50kg
T-35158	2.8 VB	-
T-35163	251/351 VB	-

› BALL ATTACHMENT BOXES



Reference	Designation	Attachment	Static Charge	GW	Ref.	GW max.
T-35501	Attachment box AK 160	Ø 50	120 kg	1600 kg	T-36213	1300 kg
T-35502	Attachment box AK 300	Ø 35 / 40 / 45 / 50	120 kg	3000kg	T-36220	2004 kg
T-35503	Attachment box AK 35	Ø 35 / 40 / 45 / 50	200 kg	3500kg	T-36227	2000 kg
T-35507	Attachment box AK 160	Ø 35	120 kg	1600kg	T-36228	3004 kg
T-34026	Attachment box KQ 14	60 mm	100 kg	1400kg	T-36229	3054 kg
T-34027	Attachment box K 7.5	60 mm	75 kg	750 kg		
T-34028	Attachment box AK 7	40 mm	75 kg	750 kg		
T-34029	Attachment box AK 7	45 mm	75 kg	750 kg		
T-34030	Attachment box AK 7	50 mm	75 kg	750 kg		

› HOOKS



Ball hook Ø 50

Attachment 2 holes
Ø 17 x 90
GW: 3.5 tonnes

Ball ISO Ø 50

GW: 3.5 tonnes

Fixed hook

Drilled 4 holes
Ø 17 40 x 90 mm
For ball joint Ø 50
or ring 42 x 68
GW: 3.5 tonnes

Ball cover Ø 50

Manoeuvring and repair support

Drilled 2 holes
Ø 17 x 90 mm
Towing ball joint: Ø 50:
1.5 tonnes
Spindle haulage Ø 32:
3.5 tonnes

Manoeuvring and repair support

Drilled 4 holes
Ø 13 x 85.7 x 44.45 mm
Towing ball joint: Ø 50:
3.5 tonnes
Spindle haulage Ø 32:
8 tonnes

T-34032

T-34035

T-34220

T-34040

T-34120

T-34141

› ANTI-THEFT DEVICES



Anti-theft box not hitched
For semi-automatic and automatic hitching
T-36060



Anti-theft box hitched and not hitched
For semi-automatic and automatic hitching
T-36065



Anti-theft device SAFETY
For AK 160 and AK 300
T-35111 Ø 35
T-35118 Ø 50



Anti-theft device SAFETY Ø 50
For AK 350 and AK 351
T-35120



Anti-theft device for fastener
Automatic type KG 14
T-35116



Anti-theft device for semi-automatic closing type AK7 and for automatic closing type EM 150 RA, EM 220 RA, EM 300 RB, EM 350 RB
T-35115



Anti-theft device for AK 1300
T-35121



Anti-theft device for AK 160, 300 and 350
T-35117

> MUDGUARD

– DOUBLE MUDGUARD – Galvanised steel



European model

Designation	W	L	H	Reference
A 1313	220	1400	350	T-31209
A 1414	230	1520	400	T-31211

– SINGLE MUDGUARD – Galvanised steel



European model

Designation	W	L	H	Reference
A 13	220	750	350	T-31205
A 14	220	800	370	T-31207



Reinforced model

Designation	W	L	H	Reference
A 1313	180	1410	270	T-31212
A 1414	230	1610	330	T-31214



Reinforced model

Designation	W	L	H	Reference
A 13	180	770	300	T-31204
A 14	230	880	340	a



Model BM

Designation	W	L	H	Reference
A 1313	235	1440	280	T-31217



Model BM

Designation	W	L	H	Reference
A 13	235	735	290	T-31215



Reference	Mudguard only	Fitting	Mudguard + Fitting
Mudguardl.8 (550 x 155 x 240)	Red	T-31114	T-31119
	Yellow		T-31151
	Turquoise		T-31152
	Grey		-
Mudguard l. 10 (650 x 180 x 280)	Red	T-31116	T-31118
	Yellow		T-31161
	Turquoise		-
	Grey		-
Mudguard l.13 (705 x 205 x 235)	Red	T-31121D T-31121G	T-31124 D/G
	Yellow		-
	Turquoise		T-31182 D/G T-31183 D/G
	Grey		T-31523
Mudguard l.14 (790 x 228 x 380)	Red	T-31140	T-31126 D/G T-31191 D/G T-31192 D/G
	Yellow		-
	Turquoise		-
	Grey		-
Mudguard l.10 R13 (650 x 205 x 280)	Red	T-31130D T-31130G	-
	Yellow		-
	Turquoise		-
	Grey		T-31173 D/G
Plastic mudguard	Black	-	-

> WHEEL ACCESSORIES



Welding spindle and hub flange for trolley wheel

Flange supplied with 4 bolts

Designation	Reference	For wheels
Spindle Ø 25 (with washer and pin)	T-30002	Launching wheel
Spindle Ø 40 (with washer and pin)	T-30003	Hub T-24101
Drilling flange 4 holes 115 x 4	T-30102	Wheel 16 x 6.5 x 8



Rubber mudflap for wheel 13"

Dimensions: 240 x 190

T-31250



Rubber mudflap for wheel 14"

Dimensions: 260 x 230

T-31251

> SPARE WHEEL SUPPORTS



Spare wheel support for boat carrier

For wheel 13 / 14 - Sold with flanges
Winch carrier mounting

T-30212	Without flanges
T-30214	Flange 80 x 40
T-30218	Flange 80 x 60
T-30222	Flange 100 x 50
T-30224	Flange 120 x 60



Spare wheel support for boat carrier

For wheel 8 - 10 fixed to drawbar

T-30211



Spare wheel support RPMS

T-30216 RPMS 501 - 901
T-30312 RPMS 321 - 455



Spare wheel support

T-30220 Series P
T-100629 BXX S 190 AB
T-30322 Series S A

> WHEEL CHOCKS



Wheel chock for car carrier

With slats

T-30302

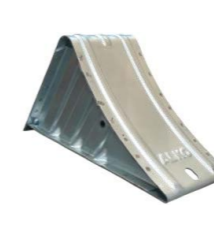

Standard wheel chock ALKO

T-30310



Wheel chock support ALKO

T-30311



Plastic wheel chock with support

T-30305

> SUSPENSION ACCESSORIES



Rubber stop B100

Ø 115 - Ht: 133
Screws M16 - L: 45

T-07009

Rubber stop B100

Thread Ø 8 - Ht: 72
Screws M8 - L: 15

T-55023



Suspension ring 3 spirals

L: 110 mm - W: 35 mm
Sold in 2s

T-07010



Suspension ring 5 spirals

L: 110 mm - W: 50 mm
Bore: 2 x Ø 14
Sold in 2s

T-07015



Suspension ring 8 spirals

L: 140 mm - W: 50 mm
Bore: 2 x Ø 14
Sold in 2s

T-07016

› MANUAL HYDRAULIC PUMPS



- | Manual hydraulic pump
Single acting
Aluminium body
T-32401 1 Litre
- | Manual hydraulic pump
Single acting - Plastic tank
Aluminium body
T-32448 2 Litres
T-32449 3 Litres
T-32450 5 Litres
T-32451 7 Litres
- | Steel manual hydraulic pump
Single acting
T-32405 2 Litres
T-32406 6 Litres
T-32416 2 Litres - Piston 21
- | Eco manual hydraulic pump
Single acting - Plastic tank
T-32476 4 Litres
- | Pump lever
T-32403
- | Pump lever
T-32453
- | Double acting
T-32431 2 Litres - Piston 20
T-32434 4 Litres - Piston 16
- | Pump support
T-32407
- | Pump lever
T-32408
- | Pump support
T-32407
- | Pump lever
T-32408



› MANUAL HYDRAULIC PUMP ACCESSORIES



- | Reservoir for eco pump
Capacity: 4 litres
T-32478
- | Reservoir for manual pump
Capacity: 2 litres
T-70301
- | Reservoir for manual pump
Capacity: 6 litres
T-70303
- | Reservoir for aluminium pump
T-32447 3 Litres
T-32446 5 Litres
T-32445 7 Litres



- | Pump head
T-32412
T-32413
T-32411
- | Aluminium pump lever
T-32415
- | Tank cap
Steel body
T-32418
- | Pump valve
Steel
T-32409
- | Pump valve
Aluminium
T-32454

› GASKET SETS

- | Aluminium manual pump gasket set
T-32424
 - | Pump head gasket set
T-32425
T-32426
T-32427
 - | Gas strut gasket set
- | Reference | Diameter | Reference | Diameter |
|----------------|----------|----------------|----------|
| T-32706 | 30 | T-32761 | 60 |
| T-32711 | 40 | T-32771 | 70 |
| T-32731 | 45 | T-32781 | 80 |
| T-32751 | 50 | T-32746 | 90 |
| T-32716 | 55 | T-32786 | 100 |

› MANUAL HYDRAULIC PUMPS



- | Single acting hydraulic cylinder
Ø 40 - Stroke: 200 mm
Force: 2.5 tonnes
T-32511
Ø 40 - Stroke: 300 mm
Force: 2.5 tonnes
T-32510
Other dimensions on request
- | Cylinder 2 expansions BMS
Stroke: 620 mm
T-32515
| Bearing Ø 40 mm
T-32517
| Swivel fitting
T-32516
- | Cylinder 3 expansions RBH
Stroke: 900 mm
T-32514
| Bearing Ø 45 mm
T-32513
| Swivel fitting
T-32516
- | Hydraulic prop
Support Ø 68
Stroke 190 mm
T-32509

› GAS STRUTS FOR HYDRAULIC TROLLEY

Reference	Type	Ø	Stroke	Gasket kit ref.
T-32710	U3040-U4040	40	225	T-32717
T-32715	U6040	55	225	T-32716
T-32720	U8040	60	225	T-32761
T-32725	U12040	70	225	T-32771
T-32735	U16040	80	225	T-32781
T-32745	U20040	90	225	T-32746

› CONNECTIONS



Reference	Type
T-32529	400 mm
T-32546	500 mm
T-32532	600 mm
T-32531	800 mm
T-32535	1700 mm
T-32533	2000 mm
T-32534	2400 mm

Other lengths on request



- | Hydraulic hose
- | Parachute valve
T-32602
- | Double pilot valve
Cylinder 7615
T-71359
- | In-line hand pump
Single acting
Piston 20
T-32419
- | Electric pump relay
T-32458
- | Electric control box
T-32603
- | Pilot valve
VB3 318
T-71485
T-32470 Electric
- | Faucet 2/3 ways 3/8
A: 2 ways
B: 3 ways
T-32600



- | Ball valve 3/8
T-32601
- | Hydraulic connection
on request
- | Electric pump cap
T-33373
- | Reservoir 7 L Electric pump
T-33373

> HARDWARE



| Side wall
T-38030



| Side wall with key
T-38031



| Complete bolt-on hinge
Supplied with hinge
L: 220 x 56
T-38052



| Axle shock absorber
Small
Travel 160/220mm
Attachment: Ø10
T-38038



| Axle shock absorber
Large
Travel 225/410mm
Attachment: Ø12
T-38036



| Floor screws

Reference	Self-drilling
T-39504	5.5 x 38
T-39505	5.5 x 45

> FASTENERS



| Side wall closure
T-38044 105mm
T-38043 175mm



| Fly's wing fastener
T-38060 Right
T-38061 Left



| "P"-type fastener
T-38065 Right
T-38066 Left



| "P" fastener
T-38051



| Side wall closure
With keeper
T-38050



| Spring closure
T-38082
T-38083 Small



| Eccentric fastener
Small bolt-on model
T-38081



| Eccentric fastener
Large weld-on model
T-38085

> RETAINING STRAPS



| Retaining strap 1000kg
Length: 5 m - Width: 25 mm
Force: 1000 kg
T-33201



| Retaining strap 2500kg
Length: 5 m - Width: 35 mm
Force: 2500 kg
T-33252



| Retaining strap 5000kg
Length: 5 m - Width: 50 mm
Force: 5000 kg
T-33301

> CONSUMABLES



| Cold galvanising aerosol
T-39801

> TARE PLATE

PTC: 500 Kg
PV: 230 Kg
L: 3.30 m
I: 1.98 m
S: 6.53 m ²

| Tare plate
T-70718

When ordering tare plates, please indicate the serial number of your trailer.

> BOXES (ON REQUEST)



| Aluminium box
760 x 330 x 245mm



| Waterproof storage box
External dimensions: L 515 x W 220 x H 277mm
Internal dimensions: L 457 x W 185 x H 232mm

> RAMPS



| Loading ramp galvanised steel
Max load: 250 kg per ramp.
T-40998 Length 1.5 m
T-40988 Length 2 m



> GAS CYLINDERS



| Gas cylinder

Reference	Strength	Ø Rod	Lg attachment	Stroke
T-33100	30 kg	8	405	160
T-33102	40 kg	8	405	160
T-33104	40 kg	8	600	250
T-33101	45 kg	8	490	200
T-33107	55kg	10	700	300
T-33103	60 kg	8	405	160
T-33105	60 kg	8	600	250
T-33106	80 kg	10	600	250
T-33108	80 kg	14	800	350
T-33109	130 kg	14	600	250
T-33110	150 kg	14	700	300
T-33111	150 kg	14	800	350

Other models on request

> TARPAULIN COVERS AND ACCESSORIES



Flat tarpaulin



High tarpaulin

To order a tarpaulin for a trailer, please send an email to:

j.schuller@mecanorem.com

Type of tarpaulin:

- Flat
- High
- Raised

Then enter the serial number of your trailer so that we can send you the reference and price of the tarpaulin suitable for your trailer.



| Steel tarpaulin hook
Height: 31 mm
Width: 15 mm
T-33360



| PVC tarpaulin hook
Series P
T-33371



| Multi-strand bungee cord
Sold by the metre
T-33369 Ø 5
T-33370 Ø 9

> CUSTOM AXLES

- AXLE MANUFACTURING INFORMATION SHEET -
"CUSTOM-MADE"

INFORMATION:

Company: Address:
Surname:
First name: Phone:

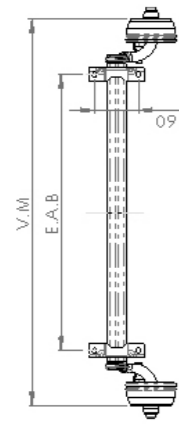
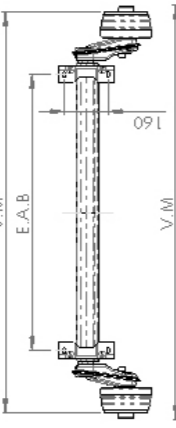
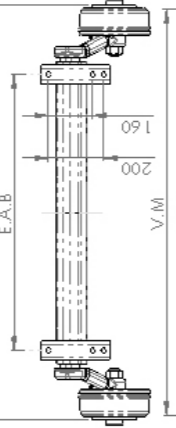
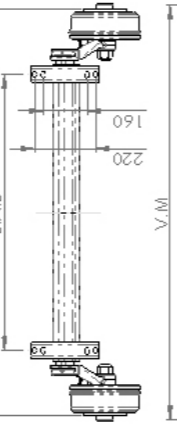
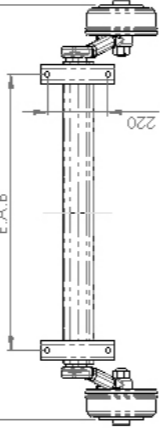
	<p>Force : 750kg <input type="checkbox"/></p>	<p>EA.B =mm VM = E.A.B + 440 mm</p>	<p>Perçage: 4x130 <input type="checkbox"/></p>	<p>T-22560 <input type="checkbox"/></p>
	<p>Force : 900kg <input type="checkbox"/></p>	<p>EA.B =mm VM = E.A.B + 450 mm</p>	<p>Perçage: 4x130 <input type="checkbox"/></p>	<p>T-22561 <input type="checkbox"/></p>
	<p>Force : 1350kg <input type="checkbox"/></p>	<p>EA.B =mm VM = E.A.B + 450 mm</p>	<p>Perçage: 4x130 5x112 5x140 <input type="checkbox"/></p>	<p>T-22563 <input type="checkbox"/> T-22562 <input type="checkbox"/> T-22564 <input type="checkbox"/></p>
	<p>Force : 1600kg <input type="checkbox"/></p>	<p>EA.B =mm VM = E.A.B + 470 mm</p>	<p>Perçage: 5x112 5x140 <input type="checkbox"/></p>	<p>T-22565 <input type="checkbox"/> T-22566 <input type="checkbox"/></p>
	<p>Force : 1800kg <input type="checkbox"/></p>	<p>EA.B =mm VM = E.A.B + 500 mm</p>	<p>Perçage: 5x112 5x140 <input type="checkbox"/></p>	<p>T-22567 <input type="checkbox"/> T-22568 <input type="checkbox"/></p>

Delivery time: 1 to 2 weeks

MECANOREM S.P.A. 100013 Rue de Péronne - BP 26 50900 VAILLAGNY - France www.mecanorem.com	REPERCT	REPERCT	REPERCT	A3H 1/14
REF: 100013	REF: 100013	REF: 100013	REF: 100013	REF: 100013
REF: 100013	REF: 100013	REF: 100013	REF: 100013	REF: 100013
REF: 100013	REF: 100013	REF: 100013	REF: 100013	REF: 100013

Force =kg

Perçage: 4x130
5x112
5x140

Côté A =

Quantité =

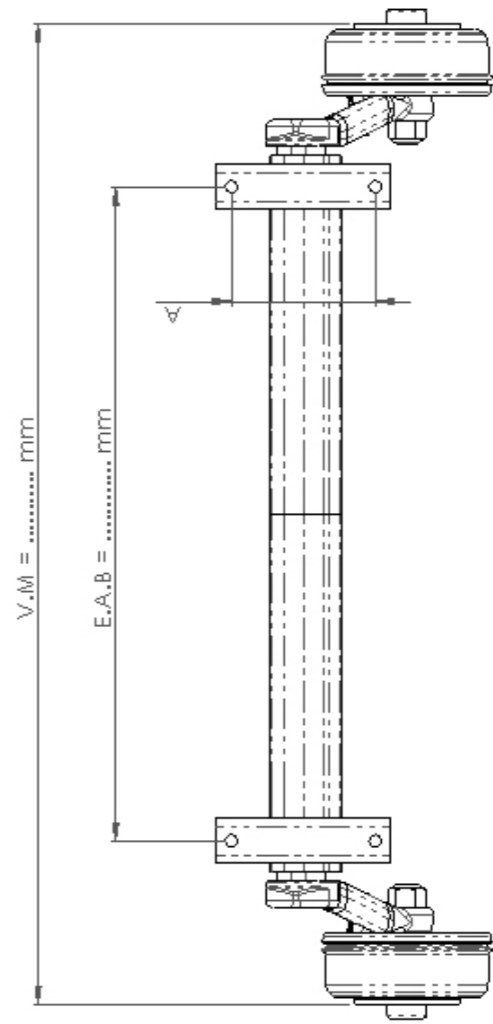

Delivery time: 6 to 8 weeks

MECANOREM S.P.A. 100013 Rue de Péronne - BP 26 50900 VAILLAGNY - France www.mecanorem.com	REPERCT	REPERCT	REPERCT	A3H 1/14
REF: 100013	REF: 100013	REF: 100013	REF: 100013	REF: 100013
REF: 100013	REF: 100013	REF: 100013	REF: 100013	REF: 100013
REF: 100013	REF: 100013	REF: 100013	REF: 100013	REF: 100013

No claim possible without having duly completed this information sheet.
fax: 02.33.95.45.40

http://www.mecanorem.com

infomeca@mecanorem.com

› BRAKE COMPONENTS

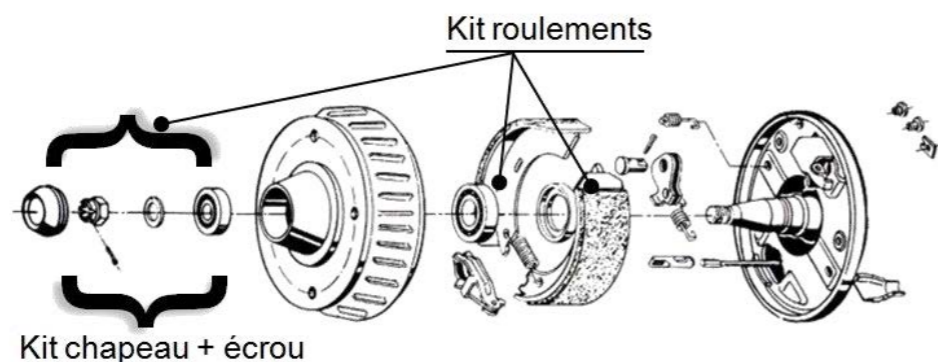

Kit chapeau + écrou

Kit roulements

Brake type	Drums		Bearings kit		Trim kit	
No.	No.	Reference	No.	Reference	No.	Reference
1637	362860	T-22360	275943	T-22340	275948	T-22330
2051	362806	T-22361	275944	T-22341	275949	T-22331
2361	560915	T-22362	275945	T-22342	275950	T-22332
2361	383653	T-22363	275951	T-22343	275950	T-22332
F306	367550	T-22365	-	T-22345	-	T-22335
Without brake	-	-	560751	T-22346	560751	T-22369
Waterproof	-	-	-	T-22347	1311409	T-22369WP

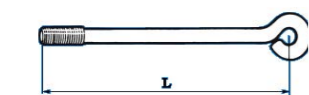

Brake rod with eye

Reference	Length	Ø
T-26145	1450	M10
T-26151	1600	M10
T-26150	1800	M10

Threaded brake rod

Length	1000	1200	1500	2000	2500	3000	3000
Ø	M10	M10	M10	M10	M10	M10	M12
Reference	T-26110	T-26115	T-26137	T-26154	T-26156	T-26157	T-26141

AL-KO

Ball brake cables for brakes 1637, 2051, 2361

Reference	Length
T-22381 B	530 mm
T-22380 B	770 mm
T-22382 B	890 mm
T-22370 B	1020 mm
T-22371 B	1130 mm
T-22383 B	1320 mm
T-22384 B	1430 mm
T-22385 B	1620 mm

AL-KO

Brake cables

Other references on request

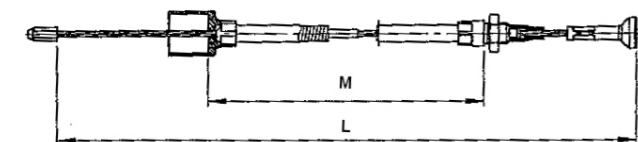

- CROSS-PIECES -



Single cross-piece
T-26065 ALKO



Double cross-piece
T-26064 ALKO



Cable clamp Ø with yoke
T-16610



Joint support for threaded rod
T-26171

› BEARINGS

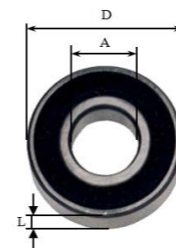

Straight bearings

Reference	Type	D	A	L
T-27002	6002 E	32	15	9
T-27004	6202 E	35	15	11
T-27027	6212 E	110	60	22
T-27006	6003 E	35	17	10
T-27008	6203 E	40	17	12
T-27010	6303 E	47	17	14
T-27012	6004 E	42	20	12
T-27014	6204 E	46	20	14
T-27016	6304 E	52	20	15
T-27018	6005 E	47	25	12
T-27020	6205 E	52	25	15
T-27022	6305 E	62	25	17
T-27024	6006 E	55	30	13
T-27026	6206 E	62	30	16
T-27028	6306 E	72	30	19
T-27023	6007 E	62	35	14
T-27025	6208 E	80	40	18
T-27029	6308 E	90	40	23



Conical bearings

Reference	Type	D	A	L
T-27039	30203	40	17	13
T-27040	30204	47	20	15
T-27042	30205	52	25	16.3
T-27044	30206	52	30	17.4
T-27046	30207	72	35	18.3
T-27048	30208	80	10	20
T-27049	30209	85	45	20.4
T-27041	30211	100	55	22.75
T-27050	32005	47	25	17.2
T-27051	32006	55	30	17.5
T-27052	32206	62	30	21.25



Roller bearings

Reference	D	A	L	Use
T-27068	40	30	85	For tyre wheels Ø 300
T-27070	50	35	82	For wheels 16 x 4/6/10
T-27072	60	40	115	For trolley hub 450 to 2500
T-27074	60	45	98	For wheels 18.7 x 8

> SEALS



Lip joint (SPI)				
Ref.	Ø int.	Ø ext.	Thickness	
T-27301	25	52	7	
T-27302	30	52	7	
T-27309	30	47	7	
T-27303	30	62	7	
T-27315	32	52	7	
T-27310	35	52	7	
T-27304	35	62	7	
T-27306	25	52	8	
T-27305	42	72	8	
T-27308	45	62	8	
T-27311	45	68	8	
T-27314	38	52	10	

| Flat washer 43 x 80 x 6
T-39416

> RINGS For launching wheel Ø 260 - 400



| Ring Ø 20
T-29512

| Ring Ø 25
T-29511

| Ring Ø 25 + bearing 35 x 25 x 55
T-27066

| Mécandus pin 8 x 80
T-39602

> WHEEL HUBS AND SCREWS



| Steel hub

Ref.		Drilling
T-24043	750 kg to weld	130 x 4
T-24041	750 kg to weld	115 x 4

| Agricultural axle
Sold with grease nipple

Ref.		Drilling
T-24105	Axle end CH 1000 / 1500	4 x 130
T-22805	Agricultural axle CH 2000	5 x 140
T-22806	Agricultural axle CH 2500	5 x 140

– WHEEL SCREW KIT –
Sold in blister pack

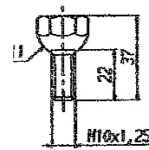

| Screws M10
Pack of 4
T-28010

| Screws M12
Pack of 5
T-28012

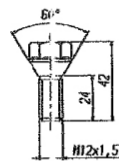

| Screws M12 x 150
Conical 4 x 100
T-22451

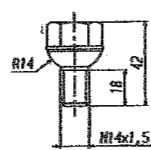

| Screws M14 x 150
Pack of 5
T-22375

| Screws M12 x 150
Spherical 5 x 112
T-22449



| Hub with bearing
For trolley
Bore Ø 40
130 x 4
T-24101

> HOUSINGS



| Housings ALKO
Sold individually
Steel with flange

Ref.	Ø
T-24504	40
T-24505	48
T-24506	55
T-24507	56
T-24508	66



| Housings for agricultural hub
Sold individually
Steel with flange

Ref.	Ø
T-24513	53
T-24512	63

ALKO



MECANOREM
Route de Saint-Sauveur - BP 305
50700 Valognes
France

ORDER FORM

After-sales service:

Fax: +33 (0)2 33 95 45 40

E-mail: infomeca@mecanorem.com

Client:

Mecanorem Client Code: Company name:

Transport:

EXPRESS
Max: 30kg
D+1 working / 1.00pm

COURRIER SERVICE
From 1 to 500 kg
2 to 3 working days

WITH TRAILER ON ORDER

Order:

Reference	Description	Qty	Reference	Description	Qty
01			09		
02			10		
03			11		
04			12		
05			13		
06			14		
07			15		
08			16		

N.B.: Line No. _____ for trailer

Series number VHT:

--	--	--	--	--	--	--	--	--	--	--	--	--	--	--	--	--	--	--	--	--

N.B.: Line No. _____ for trailer

Series number VHT:

--	--	--	--	--	--	--	--	--	--	--	--	--	--	--	--	--	--	--	--	--

Document created by: **Signature:**

Position:

Order sending by:

Fax: +33 (0)2 33 95 45 40

E-mail: infomeca@mecanorem.com

GENERAL CONDITIONS: Standard for the account

MECANOREM

Lessee-manager of the MECADIS fund - HEAD OFFICE: 100 rue Petit - 75165 PARIS CEDEX 19 - S.A.R.L. with capital of €
RCS Paris 431 784 164 - APE 2920Z

INDEX

A					
Braking accessories	18	Skid sets	09/10/12	Tare plates	33
Hydraulic pump accessories	30	Axles	20	Assembly plates	32
Lights accessories	07	Custom-made axles	20	Winch holder plates	25
Adapters	07			Hydraulic trolley tyres	27
Galvanising aerosols	33	F		Handling tyres	27
Shock absorbers	33	Harnesses	06	Standard tyres	26
Bulbs	05	Stop fittings	15	Brake control tightening handles	19
Suspension rings	29	Mudguard fittings	28	Jockey wheel tightening handles	17
Anti-theft devices	19	Fasteners	33	Plastic handles	09
Brake control hitches	18	Fog lights	05	Manual hydraulic pumps	30
Spindles	13	Position lights	05	Electric hydraulic pumps	31
Welding pins	29	Marker lights	05	Connection sockets	07
		Number plate lights	05	Profiles	09
		Side position lights	05		
B		Multi-function lights	04	R	
Tarpaulins	34	Towbars	19	Hertzian radio controls	25
Rings	24	Sheaths	14	Drawbar extensions	18
Rocker arms	13			Light rails	06
Batteries	05	G		Loading ramp	34
Mudflaps	29	Rollers	08	Stopper reinforcements	15
Props	17	Mudguards	28	Hydraulic pump reservoirs	30
Flanges	32	Side walls	33	Drop sides	14
Ball attachment boxes	19	Flashing lights	05	Locking washers	13
Bow stops	09			Handling wheels	27
Complete bow stops	15	J		Jockey wheel	
Rubber stops	29	Support legs	17	Hydraulic trolley wheels	27
		Hydraulic trolley rims	27	Standard wheels	26
		Galvanised handling rims	27	Bearings	23
		Standard rims	26	Hydraulic trolley bearings	27
C				S	
Brake cables	22	K		Retaining straps	34
Electric cables	06	Slider ring kits	19	Connection sockets	07
Light cables	06	Compensator kits	18	Control gussets	18
Winch cables	25	Seal kits	30	Stabilisers	19
Axle frames	14	Trim kits	22	Diabolo supports	13
Housings	24	Bearing kits	22 / 24	Axle supports	14
Wheel chocks	29			Skid supports	13
Universal joints	13	L		Hydraulic pump supports	30
Reflectors	05	Pump levers	30	Spare wheel supports	29
Hydraulic trolley inner tubes	27	Side rails	14	T	
Handling inner tubes	27			Drums	22
Standard inner tubes	26	M		Brake rods	22
Stands	14	Winch cranks	25	Drawbars	14 / 18
Hinges	33	Hubs	24	Tie rods	14
Chassis	14			Cross-members	14
Roller tracks	14	N		Strap winches	25
Storage boxes	34	Soldering nuts	18	Electric winches	25
Jockey wheel collars	17			Manual winches	25
Brake controls	18	O		V	
Cones	09	Omegas	32	Cylinders	17
Hydraulic connectors	31			Gas cylinders	34
Hitching hooks	19	P		Hydraulic cylinders	31
		Cross-pieces	22	Hydraulic trolley cylinders	31
D		Skids	08	Floor screws	33
Diabolos	08	Constructor plates	33	Wheel screws	24
		Number plates	33		
E					
Tube ends	09				
Cone sets	12				
Diabolo sets	09/10/12				
Roller sets	10/11/12				

For any information

CONTACT US:

infomeca@mecanorem.com

fax: 02 33 95 45 40



