

CATALOGO NAUTICO MARINE CATALOGUE

2023



MARCO[®]



MARCO®

Company certifications



L'AZIENDA

Più di 50 anni di storia aziendale dimostrano la grande capacità di adattamento della MARCO S.p.A. ai mutevoli scenari del tessuto economico mondiale ed al contempo la solidità della propria struttura organizzativa, votata alla crescita e al miglioramento continuo.

Nata nel 1970 come impresa a conduzione familiare, la MARCO S.p.A. è ora una realtà affermata e riconosciuta a livello mondiale, grazie ai continui investimenti nel campo della ricerca tecnologica nel settore delle pompe elettriche e degli avvisatori acustici.

In una sede di 8.000 metri quadrati, l'azienda sviluppa – tramite l'implementazione di sofisticate attrezzature e strumentazioni d'avanguardia – le due core business lines: la produzione di pompe per applicazioni professionali nei settori automotive, industriale e nautico e la fabbricazione di trombe e clacson per auto, camion e imbarcazioni.

I prodotti si contraddistinguono per l'inconfondibile eccellenza Made in Italy e per il contenuto estremamente tecnologico, oltre che per il raggiungimento continuo dei più alti standard di qualità e sicurezza, comprovati dalle numerose omologazioni e certificazioni ISO.

La costante sfida della MARCO nel proporre soluzioni sempre più performanti, le ha permesso di definirsi azienda leader nel proprio settore e di imporsi come interlocutore di riferimento della clientela di 80 Paesi diversi. La propria identità internazionale si è inoltre consolidata con la creazione nel 2010 della filiale americana, MATE USA.

DIE FIRMA

Mehr als 50 Jahre Unternehmensgeschichte zeigen die große Anpassungsfähigkeit von MARCO S.p.A. an die sich ändernden Szenarien der Weltwirtschaft und gleichzeitig die Solidität seiner Organisationsstruktur, die auf kontinuierliches Wachstum und Verbesserung ausgerichtet ist.

MARCO S.p.A. wurde 1970 als Familienunternehmen gegründet und ist heute dank kontinuierlicher Investitionen in die technologische Forschung sowohl auf dem Gebiet der Elektropumpen als auch der Hörner eine etablierte und anerkannte Realität weltweit.

In einer 8.000 Quadratmeter großen Zentrale entwickelt das Unternehmen durch die Implementierung modernster Geräte und Instrumente die beiden Kerngeschäftsbereiche: die Herstellung von Pumpen für professionelle Anwendungen in der Automobil-, Industrie- und Nautikbranche sowie die Herstellung von Hupen für Autos, Lastwagen und Boote.

Die Produktion zeichnet sich durch die unverwechselbare Qualität "Made in Italy" und dem extrem technologischen Inhalt, sowie durch die Einhaltung der höchsten Produktstandards aus, die durch die verschiedenen ISO-Zertifizierungen und Produktzulassungen belegt werden.

Die ständige Herausforderung, immer leistungsfähigere Lösungen vorzuschlagen, hat es MARCO ermöglicht, sich als führenden Marktteilnehmer im internationalen Szenario zu etablieren und seine Marke in über 80 verschiedenen Ländern zu verbreiten.

Darüber hinaus wurde seine internationale Identität 2010 mit der Gründung der amerikanischen Tochtergesellschaft MATE USA festigt.

THE COMPANY

More than 50 years of company history are proof of the great adaptability of MARCO S.p.A. to the changing scenarios of the world economy and at the same time of the solidity of its organizational structure, devoted to continuous growth and improvement.

Founded in 1970 as a family business, MARCO S.p.A. is now an established and recognized reality worldwide, thanks to continuous investments in technological research both in the fields of electric pumps and horns.

In its 8,000 square meter headquarters, the company develops – through the implementation of cutting-edge equipment and instruments – two core business lines: the production of pumps for professional applications in the automotive, industrial and nautical sectors and the manufacture of horns for cars, trucks and boats.

The production is characterized by the unmistakable Made in Italy quality and the extremely technological content, as well as for the compliance to the highest-grade product standards, proven by the various ISO certifications and product approvals.

The constant challenge of proposing increasingly performing solutions has allowed MARCO to establish itself as a leading market player on the international scenario, spreading its brand in over 80 different countries.

Moreover, its international identity was consolidated in 2010 with the foundation of the American subsidiary, MATE USA.

LA MAISON

Plus de 50 ans d'histoire de l'entreprise démontrent la grande adaptabilité de MARCO S.p.A. aux scénarios changeants de l'économie mondiale et en même temps la solidité de sa structure organisationnelle, vouée à la croissance et à l'amélioration continue.

Fondée en 1970 en tant qu'entreprise familiale, MARCO S.p.A. est aujourd'hui une réalité établie et reconnue dans le monde entier, grâce à des investissements continus dans la recherche technologique tant dans les domaines des pompes électriques que des avertisseurs sonores.

Au sein de son siège social de 8.000 m², l'entreprise développe – à travers la mise en place d'équipements et d'instrumentations de pointe – deux activités principales : la production de pompes à usage professionnel dans les secteurs automobile, industriel et nautique et la fabrication de klaxons pour voitures, camions et bateaux.

Les produits se caractérisent par la qualité incomparable du Made in Italy et le contenu extrêmement technologique, ainsi que par conformité aux normes de produits les plus élevées, prouvées par les différentes homologations et certifications ISO.

Le défi constant de proposer des solutions toujours plus performantes a permis à MARCO de s'imposer comme entreprise leader dans son marché, en diffusant sa marque dans plus de 80 pays différents.

De plus, son identité internationale s'est consolidée en 2010 avec la création de la filiale américaine MATE USA.



LA FIRMA

Más de 50 años de trayectoria empresarial demuestran la gran capacidad de adaptación de MARCO S.p.A. a los cambiantes escenarios de la economía mundial y a la vez la solidez de su estructura organizativa, dedicada al crecimiento y mejora continua.

Fundada en 1970 como una empresa familiar, MARCO S.p.A. es ahora una realidad consolidada y reconocida a nivel mundial, gracias a las continuas inversiones en investigación tecnológica tanto en el campo de las bombas eléctricas como de las bocinas.

En su sede de 8.000 metros cuadrados, la empresa desarrolla, a través de la implementación de equipos e instrumentos de última generación, dos líneas de producción fundamentales: la fabricación de bombas para aplicaciones profesionales en los sectores de automoción, industrial y náutico y la producción de bocinas para automóviles, camiones y barcos.

La producción se caracteriza por la inconfundible calidad "Made in Italy" y el contenido extremadamente tecnológico, así como por conformidad con los estándares de productos de más alto grado, comprobados por las diversas certificaciones ISO y aprobaciones de producto.

El desafío constante de proponer soluciones cada vez más eficaces ha permitido a MARCO posicionarse como un actor líder del mercado en el escenario internacional, difundiendo su marca en más de 80 países diferentes.

Además, su identidad internacional se consolidó en 2010 con la fundación de la filial estadounidense MATE USA.



A FIRMA

Mais de 50 anos de história da empresa são a prova da grande adaptabilidade da MARCO S.p.A. aos cenários de mudança da economia mundial e ao mesmo tempo da solidez da sua estrutura organizacional, vocacionada para o crescimento e a melhoria contínua.

Fundada em 1970 como uma empresa familiar, a MARCO S.p.A. é hoje uma realidade consolidada e reconhecida mundialmente, graças aos contínuos investimentos em pesquisas tecnológicas tanto no campo das bombas elétricas como das buzinas.

Na sua sede de 8.000 metros quadrados, a empresa desenvolve - por meio da implantação de equipamentos e instrumentos de última geração - duas linhas de negócios centrais: a produção de bombas para aplicações profissionais nos setores automotivo, industrial e náutico e a fabricação de buzinas para automóveis, caminhões e barcos.

A produção é caracterizada pela inconfundível qualidade Made in Italy e o conteúdo extremamente tecnológico, bem como pela contínua conformidade com dos mais altos padrões de produtos, comprovados pelas várias certificações ISO e aprovações de produto.

O desafio constante de propor soluções cada vez mais eficientes tem permitido à MARCO se firmar como um player de mercado líder no cenário internacional, divulgando sua marca em mais de 80 países.

Além disso, sua identidade internacional foi consolidada em 2010 com a fundação da subsidiária americana MATE USA.

Partnership



Associated



Associato AIB
Sistema Confindustria

1

HORNS page

APPROVED HORNS <i>AVVISATORI OMOLOGATI</i>	6
APPROVED AIR HORNS FOR VESSELS 12-20 m <i>TROMBE AD ARIA OMOLOGATE 12-20 m</i>	7
APPROVED AIR HORNS FOR VESSELS 20-75 m <i>TROMBE AD ARIA OMOLOGATE 20-75 m</i>	8
COMPRESSORS <i>COMPRESSORI</i>	9
APPROVED ELECTRONIC HORNS FOR VESSELS 12-20 m <i>TROMBE ELETTRONICHE OMOLOGATE 12-20 m</i>	10
APPROVED ELECTRONIC HORNS FOR VESSELS 20-75 m <i>TROMBE ELETTRONICHE OMOLOGATE 20-75 m</i>	11
APPROVED BELLS <i>CAMPANE OMOLOGATE</i>	12
MULTIFUNCTION ELECTRONIC WHISTLES <i>FISCHI ELETTRONICI MULTIFUNZIONE</i>	13
ACCESSORIES FOR HORNS <i>ACCESSORI PER AVVISATORI</i>	15
GAS HORNS <i>TROMBE A GAS</i>	16
ELECTRIC HORNS <i>TROMBE ELETTRICHE</i>	19
ELECTRIC AIR HORNS <i>TROMBE ELETTOPNEUMATICHE</i>	24

2

WATER TRANSFER PUMPS page

12/24V ELECTRONIC PRESSURE PUMPS <i>AUTOCLAVI ELETTRONICHE 12/24V</i>	30
12/24V ELECTRONIC PUMP KITS <i>KIT CON POMPA ELETTRONICA 12/24V</i>	35
12/24V ELECTRONIC PUMP SHOWER KIT <i>KIT DOCCIA CON POMPA ELETTRONICA 12/24V</i>	35
12/24V ELECTRONIC PUMP TANK KITS <i>KIT SERBATOIO CON POMPA ELETTRONICA 12/24V</i>	35
12/24V ELECTRONIC DECK WASHING PUMPS <i>POMPE ELETTRONICHE LAVAGGIO PONTE 12/24V</i>	36
ELECTRONIC PRESSURE SENSOR	37
PCS - PUMP CONTROL SYSTEM	38
PEEK GEAR PUMPS <i>POMPE AD INGRANAGGI IN PEEK</i>	39
12V-24V - DC	40
IMPELLER PUMPS <i>POMPE A GIRANTE</i>	45
12V-24V - DC	46
230V-110V - DC	48
SUBMERSIBLE PUMPS <i>POMPE AD IMMERSIONE</i>	49

3 DIESEL TRANSFER PUMPS page

BRONZE GEAR PUMPS <i>POMPE AD INGRANAGGI IN BRONZO</i>	52
12V-24V - DC	53
230V-110V - DC	56
VANE PUMPS <i>POMPE A PALETTE</i>	58
12V-24V - DC	59
230V - DC	60

4 DIESEL ↔ OIL TRANSFER PUMPS page

12/24V ADJUSTABLE SPEED ELECTRONIC PRESSURE PUMPS <i>POMPE ELETTRONICHE 12/24V A VELOCITÀ REGOLABILE</i>	61
SCS - SPEED CONTROL SYSTEM	65
12/24V REVERSIBLE ELECTRONIC PUMPS <i>POMPE ELETTRONICHE REVERSIBILI 12/24V</i>	66

5 OIL TRANSFER PUMPS page

BRONZE GEAR PUMPS <i>POMPE AD INGRANAGGI IN BRONZO</i>	67
12/24V - DC	68
230V-400V - DC	71
12/24V OIL CHANGE KITS <i>KIT CAMBIO OLIO 12/24V</i>	72
12/24V ELECTRONIC OIL CHANGE KITS <i>KIT CAMBIO OLIO ELETTRONICI 12/24V</i>	73
RCS - REVERSIBLE CONTROL SYSTEM	75
ACCESSORIES FOR PUMPS <i>ACCESSORI PER POMPE</i>	76

6 SEARCH LIGHTS page

RADIO CONTROLLED SEARCH LIGHTS <i>FARI RADIOCOMANDATI</i>	80
---	----

SOLENOID VALVES <i>ELETTROVALVOLE</i>	80
---	----

WARRANTY AND RETURN PROCEDURE <i>GARANZIA E RESI</i>	83
--	----

SELECTION GUIDE TABLES <i>TABELLE DI GUIDA ALLA SCELTA</i>	85-87
--	-------



IT Avvisatori sonori omologati disponibili in due versioni:
 - Ad aria, con compressore e tromba bianca o cromata (serie PW);
 - Elettronici, con altoparlante, centralina, membrana acustica a riscaldamento ultrasonico e pannello di controllo remoto (serie EW).
 Omologazioni disponibili: RINA, LLOYD'S REGISTER MCA, BUREAU VERITAS, NMMA e BSH in accordo alle norme internazionali COLREG 1972 IMO classi III e IV.

DE Zugelassene Schallsignalanlagen, in zwei Versionen erhältlich:
 - Druckluftbetrieben, mit Kompressor und weißem oder verchromtem Trichter (PW Serie);
 - Elektronisch, mit Lautsprecher, elektronischer Einheit, akustischer Membran mit ultrasonischem Wärmesystem (EW Serie).
 Verfügbare Zulassungen: RINA, LLOYD'S REGISTER MCA, BUREAU VERITAS, NMMA und BSH, gemäß den internationalen Regeln COLREG 1972 IMO Klassen III und IV.

FR Avertisseurs homologués, disponibles en deux versions :
 - A air, avec compresseur et cornet blanc ou chromé (série PW)
 - Electroniques, avec hautparleur, fiche électronique, membrane acoustique à chauffage ultrasonique et panneau de contrôle (série EW).
 Homologations disponibles : RINA, LLOYD'S REGISTER MCA, BUREAU VERITAS, NMMA et BSH, selon les normes internationales COLREG 1972 IMO classes III e IV.

EN Approved signaling horns, available in two versions:
 - Air operated, with compressor and white or chromed trumpet (PW series);
 - Electronic, with loudspeaker, control unit, acoustic membrane with ultrasonic heating system and remote control panel (EW series).
 Available approvals: RINA, LLOYD'S REGISTER MCA, BUREAU VERITAS, NMMA and BSH according to international regulations COLREG 1972 IMO classes III e IV.

ES Bocinas homologadas disponibles en dos versiones:
 - De aire, con compresor y corneta blanca o cromada (serie PW);
 - Electrónicas, con altavoz, unidad electrónica, membrana acústica a calefacción ultrasónica, y panel de control (serie EW).
 Homologaciones disponibles: RINA, LLOYD'S REGISTER MCA, BUREAU VERITAS, NMMA y BSH, según las normas internacionales COLREG 1972 IMO classes III e IV.

PT Buzinas homologadas disponíveis em duas versões:
 - A ar, com compressor e corneta branca ou cromada (serie PW);
 - Eletrónicas, com alto-falante, unidade electrónica, membrana acústica à aquecimento ultrasonico e painel de comando (serie EW).
 Homologações disponíveis: RINA, LLOYD'S REGISTER MCA, BUREAU VERITAS, NMMA e BSH, segundo as normas internacionais COLREG 1972 IMO classes III e IV.

APPROVALS



APPROVED AIR HORNS FOR VESSELS 12÷20 m

PW2



12V
24V

APPROVALS

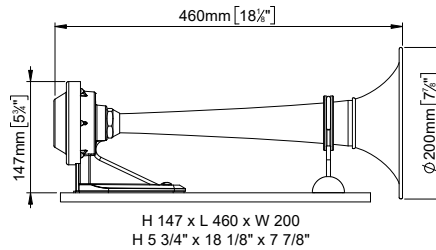

Features

- Compressor M1-W included
- Protective cap available (see page 8)

CODICE PART NUMBER	VOLT	AMP.	dB (1/3 OCT.) (1 m)	Hz	DIMENSIONI DIMENSIONS mm	Pcs. x carton
150 000 12	12	25	123	315	147 x 460 x 200	1
150 000 13	24	20	123	315	147 x 460 x 200	1

PW2-BC



12V
24V

APPROVALS

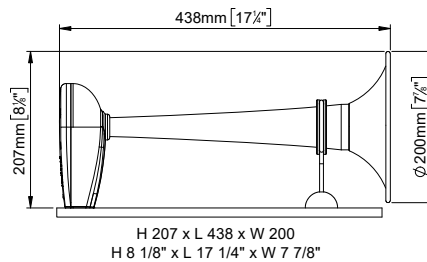

Features

- Compressor M1-W included
- Protective cap available (see page 8)

CODICE PART NUMBER	VOLT	AMP.	dB (1/3 OCT.) (1 m)	Hz	DIMENSIONI DIMENSIONS mm	Pcs. x carton
150 002 12	12	25	123	315	207 x 438 x 200	1
150 002 13	24	20	123	315	207 x 438 x 200	1

PW2-BB



12V
24V

APPROVALS

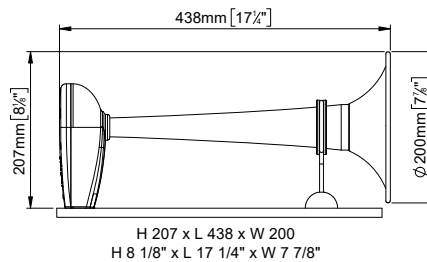

Features

- Compressor M1-W included
- Protective cap available (see page 8)

CODICE PART NUMBER	VOLT	AMP.	dB (1/3 OCT.) (1 m)	Hz	DIMENSIONI DIMENSIONS mm	Pcs. x carton
150 003 12	12	25	123	315	207 x 438 x 200	1
150 003 13	24	20	123	315	207 x 438 x 200	1

APPROVED AIR HORNS FOR VESSELS 20÷75 m

PW3



12V
24V

APPROVALS

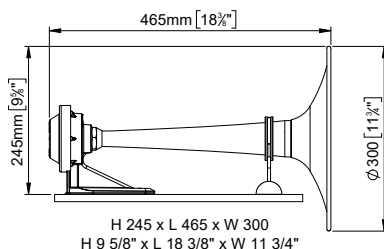

H 245 x L 465 x W 300
H 9 5/8" x L 18 3/8" x W 11 3/4"

Features

- Protective cap available (see page 8)

CODICE PART NUMBER	VOLT	AMP.	dB (1/3 OCT.) (1 m)	Hz	DIMENSIONI DIMENSIONS mm	Pcs. x carton
152 000 12	12	4,5	132	315	245 x 465 x 300	1
152 000 13	24	2,5	132	315	245 x 465 x 300	1

PW3-BC



12V
24V

APPROVALS

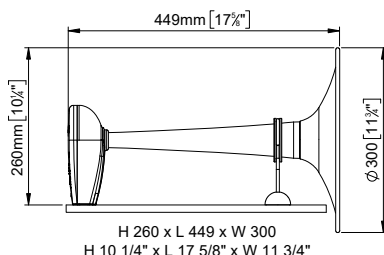

H 260 x L 449 x W 300
H 10 1/4" x L 17 5/8" x W 11 3/4"

Features

- Protective cap available (see page 8)

CODICE PART NUMBER	VOLT	AMP.	dB (1/3 OCT.) (1 m)	Hz	DIMENSIONI DIMENSIONS mm	Pcs. x carton
152 002 12	12	4,5	132	315	260 x 449 x 300	1
152 002 13	24	2,5	132	315	260 x 449 x 300	1

PW3-BB



12V
24V

APPROVALS

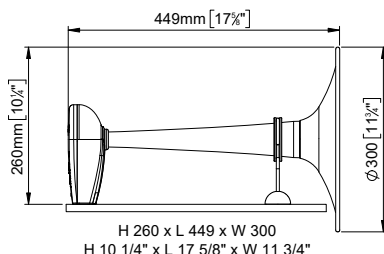

H 260 x L 449 x W 300
H 10 1/4" x L 17 5/8" x W 11 3/4"

Features

- Protective cap available (see page 8)

CODICE PART NUMBER	VOLT	AMP.	dB (1/3 OCT.) (1 m)	Hz	DIMENSIONI DIMENSIONS mm	Pcs. x carton
152 003 12	12	4,5	132	315	260 x 449 x 300	1
152 003 13	24	2,5	132	315	260 x 449 x 300	1

Spare parts and accessories

Protective cap for PW2

Part No. R50 000 06



Protective cap for PW3

Part No. R52 000 06



COMPRESSOR FOR APPROVED HORNS

M3

Features

- SUITABLE FOR PW3 AND MULTITONE HORNS
- Push-on fitting
- 8 liters tank

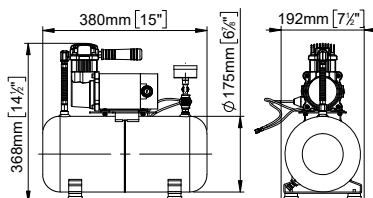

H 368 x L 380 x W 192
H 14 1/2" x L 15" x W 7 1/2"

CODICE PART NUMBER	VOLT	PORTATA AIR FLOW RATE	PRESSIONE PRESSURE	MOTORE MOTOR	ATTACCO CONNECTION	DIMENSIONI DIMENSIONS mm	PESO WEIGHT
135 100 12	12	47 l/min	8 bar / 116 psi	240 W	Ø 6 mm int.	368 x 380 x 192	9 Kg
135 100 13	24	47 l/min	8 bar / 116 psi	240 W	Ø 6 mm int.	368 x 380 x 192	9 Kg

M1-W

Features

- SUITABLE FOR PW2
- Push-on fitting
- Oil free

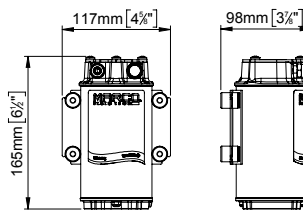

H 165 x L 117 x W 98
H 6 1/2" x L 4 5/8" x W 3 7/8"

CODICE PART NUMBER	VOLT	PORTATA AIR FLOW RATE	PRESSIONE PRESSURE	MOTORE MOTOR	CORPO BODY	ROTORE ROTOR	ALBERO SHAFT	ATTACCO CONNECTION	DIMENSIONI DIMENSIONS mm	PESO WEIGHT
R50 000 33	12	60 l/min	2 bar / 29 psi	180W	Alluminio Aluminium	Alluminio Aluminium	AISI 303	Ø 6 mm int.	165 x 117 x 103	2,4 kg
R50 000 34	24	60 l/min	2 bar / 29 psi	180W	Alluminio Aluminium	Alluminio Aluminium	AISI 303	Ø 6 mm int.	165 x 117 x 103	2,4 kg

APPROVED ELECTRONIC HORNS FOR VESSELS 12÷20 m

EW2



SB-UV INCLUDED

12V
24V

APPROVALS

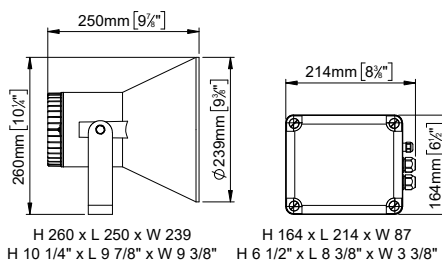

Features

- Horn
- Automatic fog signal
- Control Panel SB-UV included (see page 15)

CODICE PART NUMBER	VOLT	AMP.	dB (1/3 OCT.) (1 m)	Hz	DIMENSIONI DIMENSIONS mm	Pcs. x carton
150 040 12	12	3	122	690	260 x 250 x 239	1
150 040 13	24	1,5	122	690	260 x 250 x 239	1

EW2-M



SB-UV INCLUDED

12V
24V

APPROVALS

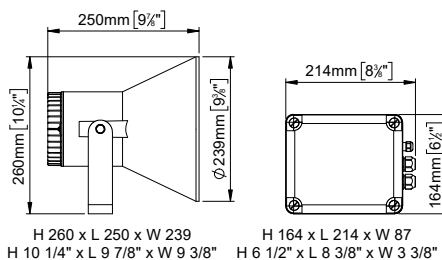

Features

- Horn
- Automatic fog signal
- VHF Input
- Microphone
- Control Panel SB-UV included (see page 15)

CODICE PART NUMBER	VOLT	AMP.	dB (1/3 OCT.) (1 m)	Hz	DIMENSIONI DIMENSIONS mm	Pcs. x carton
150 041 12	12	3	122	690	260 x 250 x 239	1
150 041 13	24	1,5	122	690	260 x 250 x 239	1

EW2-MS



SB-UV INCLUDED

12V
24V

APPROVALS

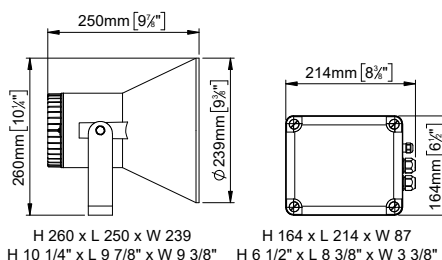

Features

- Horn
- Automatic fog signal
- VHF Input
- Microphone
- Siren
- Control Panel SB-UV included (see page 15)

CODICE PART NUMBER	VOLT	AMP.	dB (1/3 OCT.) (1 m)	Hz	DIMENSIONI DIMENSIONS mm	Pcs. x carton
150 044 12	12	3	122	690	260 x 250 x 239	1
150 044 13	24	1,5	122	690	260 x 250 x 239	1

APPROVED ELECTRONIC HORNS FOR VESSELS 20÷75 m

EW3



SB-UV INCLUDED

24V

APPROVALS



Features

- Horn
- Automatic fog signal
- Control Panel SB-UV included (see page 15)

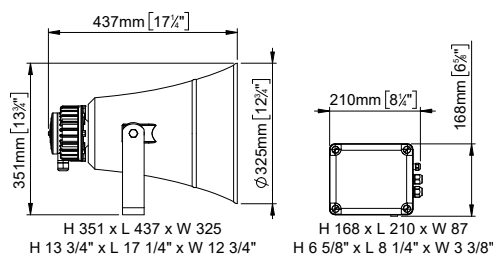

CODICE PART NUMBER	VOLT	AMP.	dB (1/3 OCT.) (1 m)	Hz	DIMENSIONI DIMENSIONS mm	Pcs. x carton
152 063 13	24	5	131	698	351 x 437 x 325	1

EW3-M



SB-UV INCLUDED

APPROVALS



Features

- Horn
- Automatic fog signal
- VHF Input
- Microphone
- Control Panel SB-UV included (see page 15)

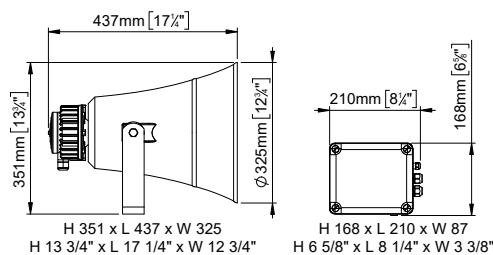

CODICE PART NUMBER	VOLT	AMP.	dB (1/3 OCT.) (1 m)	Hz	DIMENSIONI DIMENSIONS mm	Pcs. x carton
152 060 13	24	5	131	698	351 x 437 x 325	1

EW3-MS



SB-UV INCLUDED

APPROVALS



Features

- Horn
- Automatic fog signal
- VHF Input
- Microphone
- Siren
- Control Panel SB-UV included (see page 15)

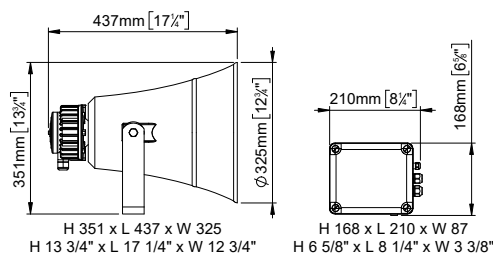

CODICE PART NUMBER	VOLT	AMP.	dB (1/3 OCT.) (1 m)	Hz	DIMENSIONI DIMENSIONS mm	Pcs. x carton
152 064 13	24	5	131	698	351 x 437 x 325	1

APPROVED BELLS FOR VESSELS 12÷20 m

BE2



Features

- Polished brass
- Ø 200 mm
- RINA Approved

CODICE PART NUMBER	MATERIALE MATERIAL	DIMENSIONI DIMENSIONS mm	PESO WEIGHT kg	Pcs. x carton
150 020 10	ottone polished brass	Ø200	2,5	1

BE2-C



Features

- Chromed brass
- Ø 200 mm
- RINA Approved

CODICE PART NUMBER	MATERIALE MATERIAL	DIMENSIONI DIMENSIONS mm	PESO WEIGHT kg	Pcs. x carton
150 021 10	ottone cromato chrome plated brass	Ø200	2,5	1

APPROVED BELLS FOR VESSELS 20÷75 m

BE3



Features

- Polished brass
- Ø 300 mm
- RINA Approved

CODICE PART NUMBER	MATERIALE MATERIAL	DIMENSIONI DIMENSIONS mm	PESO WEIGHT kg	Pcs. x carton
152 020 10	ottone polished brass	Ø300	8	1

BE3-C



Features

- Chromed brass
- Ø 300 mm
- RINA Approved

CODICE PART NUMBER	MATERIALE MATERIAL	DIMENSIONI DIMENSIONS mm	PESO WEIGHT kg	Pcs. x carton
152 021 10	ottone cromato chrome plated brass	Ø300	8	1



IT Fischi elettronici completi di altoparlante stagno con staffa in acciaio inox AISI 316 e scheda elettronica. Disponibili le versioni con segnale automatico per nebbia, microfono, sirena personalizzabile e entrata VHF e stereo.

DE Elektronische Schallsignalanlage, mit wasserdichtem Lautsprecher, Haltebügel aus Edelstahl AISI 316 und elektronischer Einheit. Erhältlich auch in den Versionen mit automatischem Signal für Nebel, VHF- und Stereo-Eingang, Mikrophon, und anpassbarer Sirene.

FR Avertisseur électronique équipé d'haut-parleur étanche, étrier en acier inoxydable AISI 316 et centrale électronique. Versions disponibles avec signal de brume automatique, microphone, sirène personnalisable et entrée VHF et stéréo.

EN Waterproof electronic horns complete with loudspeaker, AISI 316 stainless steel bracket and electronic unit. Available with automatic fog signal, microphone, customizable siren, VHF and stereo input.

ES Bocina electrónica con altavoz estanco, abrazadera en acero inox AISI 316 y ficha electrónica. Versiones disponibles con señal automática de niebla, micrófono, sirena personalizable, entrada VHF y estéreo.

PT Buzina electrónica com alto-falante estanque, suporte em aço inox AISI 316 e ficha electrónica. Versões disponíveis com sinal automático de nevoeiro, microfone, sirena personalizável, entrada VHF e estéreo.

AVAILABLE FUNCTIONS



TROMBA
HORN



SEGNALE NEBBIA
AUTOMATIC FOG SIGNAL



VHF
INPUT



MICROFONO
MICROPHONE



SIRENA
SIREN



STEREO
INPUT

EMH



12V
24V

Features

- Horn
- Automatic fog signal
- IP66
- Stainless steel bracket

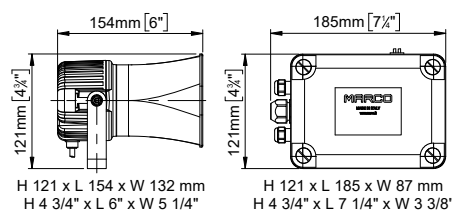

CODICE PART NUMBER	VOLT	AMP.	PROTEZIONE PROTECTION	dB (1/3 OCT.) (1m)	Hz	DIMENSIONI DIMENSIONS mm	Pcs. x carton
136 000 12	12	1,5	IP66	112	800	121 x 154 x 132	1
136 000 13	24	1	IP66	112	800	121 x 154 x 132	1

EMH-M



12V
24V

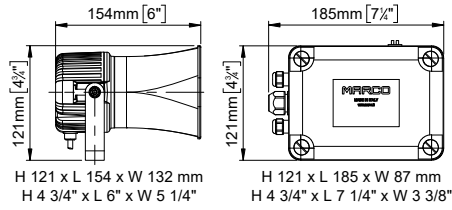

Features

- Horn
- Automatic fog signal
- VHF Input
- Microphone
- IP66
- Stainless steel bracket

CODICE PART NUMBER	VOLT	AMP.	PROTEZIONE PROTECTION	dB (1/3 OCT.) (1m)	Hz	DIMENSIONI DIMENSIONS mm	Pcs. x carton
136 001 12	12	1,5	IP66	112	800	121 x 154 x 132	1
136 001 13	24	1	IP66	112	800	121 x 154 x 132	1

EMH-MS



12V
24V

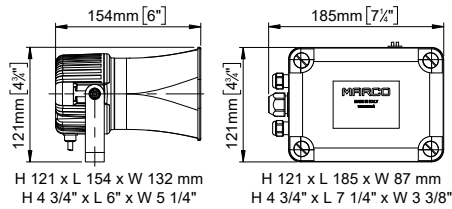

Features

- Horn
- Automatic fog signal
- VHF Input
- Microphone
- Siren
- IP66
- Stainless steel bracket

CODICE PART NUMBER	VOLT	AMP.	PROTEZIONE PROTECTION	dB (1/3 OCT.) (1m)	Hz	DIMENSIONI DIMENSIONS mm	Pcs. x carton
136 002 12	12	1,5	IP66	112	800	121 x 154 x 132	1
136 002 13	24	1	IP66	112	800	121 x 154 x 132	1

EMH-2



12V
24V

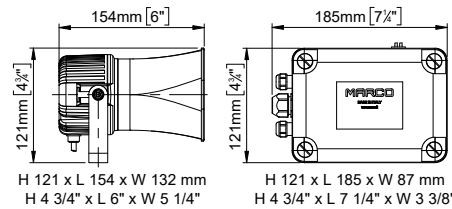

Features

- Horn
- Automatic fog signal
- VHF Input
- Microphone
- Siren
- Stereo Input
- IP66
- Stainless steel bracket

CODICE PART NUMBER	VOLT	AMP.	PROTEZIONE PROTECTION	dB (1/3 OCT.) (1m)	Hz	DIMENSIONI DIMENSIONS mm	Pcs. x carton
136 012 12	12	1,5	IP66	115	800	121 x 154 x 132	1
136 012 13	24	1	IP66	115	800	121 x 154 x 132	1

EMH-L

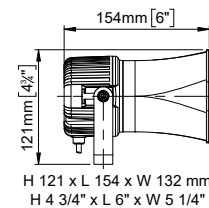

Features

- IP66
- Stainless steel bracket

CODICE PART NUMBER	PROTEZIONE PROTECTION	OHM Ω	W	DIMENSIONI DIMENSIONS mm
137 040 10	IP66	8	20	121 x 154 x 132

CONTROL PANEL FOR EW AND EMH SERIES

SB-UV

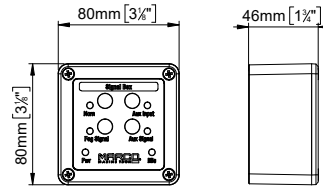

H 80 x L 80 x W 46
H 3 1/8" x L 3 1/8" x W 1 3/4"

CODICE PART NUMBER	VOLT	PROTEZIONE PROTECTION	DIMENSIONI DIMENSIONS mm	FORO HOLE mm	CONNESSIONE CONNECTION
137 020 15	12/24	IP67	80 x 80 x 46	Ø 70	RJ45

IT Il pannello di controllo per fischio elettronico viene utilizzato per operare dalla cabina. Grazie alla scheda elettronica contenuta nel pannello di controllo i tempi di installazione del fischio elettronico sono notevolmente ridotti. Con un microprocessore integrato vengono raccolte in un solo cavo RJ45 tutte le funzioni disponibili del fischio: tromba, segnale da nebbia, entrata VHF e connessione microfonica. La scheda elettronica è contenuta in una scatola impermeabile con possibilità di incasso.

DE Das Kontrollpaneel für elektronische Schallsignalanlagen wird in der Kabine angebracht. Dank der elektronischen Einheit, die ebenfalls hier eingebaut ist, wird die Installationszeit erheblich reduziert. Der integrierte Mikroprozessor überträgt auf ein einziges RJ45-Kabel alle Funktionen der Schallsignalanlage: Horn, automatisches Signal bei Nebel, VHF-Eingang. Die elektronische Einheit, mit möglichen Mikrofonanschluss, ist in einer wasserdichten Hülle montiert und kann eingelassen werden.

FR Le tableau de commande des sifflets électroniques est étudié pour montage dans la cabine. La carte électronique contenue dans le tableau de commande permet de réduire les temps d'installation du sifflet électronique. Par l'utilisation d'un microprocesseur intégré toutes les fonctions disponibles du sifflet sont réunies dans un seul câble RJ45: avertisseur, signal automatique de brouillard, entrée VHF et connexion au microphone. La carte électronique est contenue dans une boîte étanche avec possibilité d'encastrement.

EN The control panel has been designed to operate the electronic horns from the cabin. The installation time of the whistle is reduced thanks to the integrated microprocessor electronic card which transmits through only one RJ45 cable all the available functions to the whistle: horn, fog signal, aux input and microphone connection. The electronic card is contained in a waterproof box with built-in option.

ES El panel de control para bocinas electrónicas es empleado para operar desde la cabina. Gracias a la ficha electrónica contenida en el panel los tiempos de instalación de la bocina son notablemente reducidos. El microprocesador integrado transmite a un solo cable RJ45 todas las funciones disponibles: bocina, señal de niebla, entrada VHF y conexión de micrófono. La ficha electrónica está contenida en una caja impermeable y es empotrable.

PT O painel de controle para buzinas electrónicas está concebido para operar desde a cabina. Graças à ficha electrónica situada no painel os tempos de instalação da buzina são notavelmente reduzidos. O microprocessador integrado transmite num só cabo RJ45 todas as funções disponíveis: buzina, sinal para nevoeiro, entrada VHF e conexão do microfone. A ficha electrónica está montada numa caixa impermeável e é também de encaixe.

MICROPHONES

MIC1



▪ For EW/EMH Electronic Horns

TIPO TYPE	CODICE PART NUMBER	PROTEZIONE PROTECTION	CONNESSIONE CONNECTION
MIC1	137 030 10	IP67	3 PINS

MIC2



▪ For EW Approved Horns

TIPO TYPE	CODICE PART NUMBER	PROTEZIONE PROTECTION	CONNESSIONE CONNECTION
MIC2	137 032 10	IP55	4 PINS



- IT** Tromba a gas con attacco a scatto. Completa di bombola monoblocco in alluminio. Disponibile in tre versioni:
- 200 ml con gas ecologico infiammabile
 - 200 ml con gas HFO-1234ze - conforme alla direttiva europea n. 517/2014
 - 400 ml con gas HFO-1234ze - conforme alla direttiva europea n. 517/2014.

- DE** Horn mit aufsteckbarem Trichter. Mit Gasflasche FCKW frei in drei Versionen erhältlich:
- 200 ml mit entflammbarem Gas
 - 200 ml mit Gas HFO-1234ze - gemäß der europäischen Richtlinie Nr. 517/2014
 - 400 ml mit Gas HFO-1234ze - gemäß der europäischen Richtlinie Nr. 517/2014.

- FR** Corne de brume avec branchement à pression. Fourni de bouteille monobloc en aluminium disponible en trois versions:
- 200 ml avec gaz écologique inflammable
 - 200 ml avec gaz HFO-1234ze - en accord avec le règlement européen n. 517/2014
 - 400 ml avec gaz HFO-1234ze - en accord avec le règlement européen n. 517/2014.

- EN** Hand held gas horn, snap-on type, complete with aluminium bottle. Available in three versions:
- 200 ml with environmentally safe inflammable gas
 - 200 ml with gas HFO-1234ze - in agreement with the European directive nr 517/2014
 - 400 ml with gas HFO-1234ze - in agreement with the European directive nr 517/2014.

- ES** Bocina de mano con conexión a presión. Provista de botella monobloque en aluminio. Disponible en tres versiones:
- 200 ml con gas ecologico inflamable
 - 200 ml con gas HFO-1234ze - de acuerdo con la regulación europea n°517/2014
 - 400 ml con gas HFO-1234ze - de acuerdo con la regulación europea n°517/2014.

- PT** Buzina de mão com montagem a pressão. Equipada com garrafa monobloco em alumínio. Disponível em três versões:
- 200 ml com gás ecológico inflamável
 - 200 ml com gás HFO-1234ze - em conformidade com o regulamento europeu n°517/2014
 - 400 ml com gás HFO-1234ze - em conformidade com o regulamento europeu n°517/2014.

TA1

▪ Inflammable gas



200 ml

CODICE PART NUMBER	ml	dB (A) (1m)	Hz	kg	LUNGHEZZA LENGTH mm	IMBALLO PACKING
130 060 20	200	122	400	0,32	190	Blister

TA1B

▪ Refill



200 ml

CODICE PART NUMBER	ml	kg	PEZZI PCS.
130 100 00	200	0,25	1

TA1-H

▪ Not inflammable



HFO-1234ze



200 ml

CODICE PART NUMBER	ml	dB (A) (1m)	Hz	kg	LUNGHEZZA LENGTH mm	IMBALLO PACKING
130 066 20	200	122	400	0,32	190	Blister

TA1B-H

▪ Refill



200 ml

CODICE PART NUMBER	ml	kg	PEZZI PCS.
130 106 00	200	0,25	1

CTA1

▪ Snap-on trumpet



CODICE PART NUMBER	Hz	kg	LUNGHEZZA LENGTH mm
130 080 00	400	0,07	190

APPROVED GAS HORNS

TA1R



400 ml

▪ For vessels 12-50 m

Features

- **NOT INFLAMMABLE GAS**
- Stainless steel base
- 400 ml
- Approved for vessels 12-50 m

CODICE PART NUMBER	ml	dB (A) (1m)	Hz	kg	LUNGHEZZA LENGTH mm	IMBALLO PACKING	Pcs. x carton
152 041 00	400	122	400	1,1	190	Bag	12

IT Tromba a gas per imbarcazioni da diporto di lunghezza compresa tra i 12 e i 50 m. Cornetto in plastica, base con fondello in acciaio inox e bombola da 400 ml contenente gas HFO-1234ze - **conforme alla direttiva europea n. 517/2014.**

DE Horn mit 400 ml Gasflasche für Boote von 12 bis 50 m Länge. Trichter aus Plastik mit Basis aus Edelstahl. Nicht entflammbares Gas HFO-1234ze - **gemäß der europäischen Richtlinie Nr. 517/2014.**

FR Corne de brume avec cornet en plastique, base avec culot en acier inoxydable et bouteille de 400 ml contenant gaz HFO-1234ze - **en accord avec le règlement européen n. 517/2014.**

EN Gas horn complete with plastic trumpet with stainless steel base and 400 ml bottle containing non-inflammable gas HFO-1234ze - **in agreement with the European directive nr 517/2014.**

ES Bocina de mano provista de corneta de plástico con base en acero inox y botella de 400 ml que contiene gas HFO-1234ze - **de acuerdo con la regulación europea n°517/2014.**

PT Buzina de mão equipada com corneta de plástico com base em aço inoxidável, garrafa de 400 ml que contém gás HFO-1234ze - **em conformidade com o regulamento europeu n°517/2014.**

TA1X



200 ml

▪ For vessels up to 12 m

Features

- **NOT INFLAMMABLE GAS**
- Stainless steel base
- 200 ml
- Approved for vessels 12-50 m

CODICE PART NUMBER	ml	dB (A) (1m)	Hz	kg	LUNGHEZZA LENGTH mm	IMBALLO PACKING	Pcs. x carton
130 063 20	200	122	400	0,47	190	Blister	24

IT Tromba a gas disegnata appositamente per l'impiego su imbarcazioni da diporto di lunghezza fino ai 12 m, conforme al D.M. 421/90. Cornetto in plastica, base con fondello in acciaio inox e bombola da 200 ml contenente gas HFO-1234ze - **conforme alla direttiva europea n. 517/2014.**

DE Horn mit 200 ml Gasflasche für Boote bis 12 m Länge. Trichter aus Plastik mit Basis aus Edelstahl. Gas HFO-1234ze - **gemäß der europäischen Richtlinie Nr. 517/2014.**

FR Corne de brume avec cornet en plastique, base avec culot en acier inoxydable et bouteille de 200 ml contenant gaz HFO-1234ze - **en accord avec le règlement européen n. 517/2014.**

EN Gas horn, complete with plastic trumpet with stainless steel bottom plate and 200 ml bottle containing gas HFO-1234ze - **in agreement with the European directive nr 517/2014.**

ES Bocina de mano provista de corneta de plástico con base de acero inoxidable, botella de 200 ml que contiene gas HFO-1234ze - **de acuerdo con la regulación europea n°517/2014.**

PT Buzina de mão equipada com corneta de plástico com base de aço inoxidável, garrafa de 200 ml que contém gás HFO-1234ze - **em conformidade com o regulamento europeu n°517/2014.**



IT Trombe elettriche singole o in coppia sia per montaggio esterno, con possibilità di cavo a scomparsa (serie EMX-DUCK HORN), che per installazione ad incasso (SERIE SM1). Gruppo sonoro di elevata potenza, costruito in materiale anticorrosione e accuratamente protetto.

Disponibili nelle versioni:

- cromata resistente alla salsedine (MT1-H – MT1-L – MT2-SK1/C-SM1C)
- ASA bianco resistente agli UV (SK1-SM1)
- ottone verniciato (TCE)
- acciaio inox (EM1-EM2-EM1/2-EMX1-EMX2-EMX1/2-DUCK HORN)
- ABS nero (BK1-BK2).

DE Elektromagnetisches Horn, als Einzel- oder Doppelausführung Elektrische Hörner, in Einzel- oder Doppelausführung, sowohl für externe Montage mit Möglichkeit von verborgenen Kabeln (Serie EMX-DUCK HORN), als auch für Einbaumontage (Serie SM1). Die starke sorgfältig geschützte Klanggruppe ist aus antikorrosivem Material hergestellt.

Verfügbare Versionen:

- Verchromt, Salzigkeit beständig (Serie MT1-MT2-SK1/C-SM1C)
- Weiß ASA, UV-Strahlen beständig (SK1-SM1)
- Lackiertem Messing (TCE)
- Edelstahl (Serie EM – EMX – DUK HORN)
- Schwarz ABS (BK1-BK2).

FR Avertisseurs électriques, seuls ou doubles, soit pour montage externe, avec option du câble caché, soit pour montage à encastrer. Ensemble sonore très puissant et soigneusement protégé, construit avec matériel anticorrosion. Disponibles dans les versions:

- Chromés, résistantes à la salure (MT1-H – MT1-L – MT2-SK1/C-SM1C)
- ASA blanc, résistantes aux rayons UV (SK1-SM1)
- Laiton vernissé (TCE)
- Acier inox (EM1-EM2-EM1/2-EMX1-EMX2-EMX1/2-DUCK HORN)
- ABS noir (BK1-BK2).

EN Electric horns, single or double, both for external mounting, with option of integrated cable, and for built-in installation. Powerful acoustic unit carefully protected and manufactured of non-corrosive materials. Available in the following versions:

- Chromed, salt-resistant (MT1-H – MT1-L – MT2-SK1/C-SM1C)
- White ASA, UV-rays resistant (SK1-SM1)
- Painted brass (TCE)
- Stainless steel (EM1-EM2-EM1/2-EMX1-EMX2-EMX1/2-DUCK HORN)
- Black ABS (BK1-BK2).

ES Bocinas eléctricas, únicas o dobles, sea para montaje exterior, con opción de cable escondido, sea para empotrar. Unidad sonora de elevada potencia, muy bien protegida y construida en material anticorrosivo. Disponibles en las siguientes versiones:

- Cromadas, resistentes a la salinidad (MT1-H – MT1-L – MT2-SK1/C-SM1C)
- ASA blanco, resistentes a los rayos UV (SK1-SM1)
- Latón pintado (TCE)
- Acero inoxidable (EM1-EM2-EM1/2-EMX1-EMX2-EMX1/2-DUCK HORN)
- ABS negro (BK1-BK2).

PT Buzinas eléctricas, únicas ou duplas, seja para montagem externo, com opção de cabo escondido, seja para montagem de encaixe. Unidade sonora de elevada potencia, cuidadosamente protegida e fabricada com materiais anticorrosivos. Disponíveis nas seguintes versões:

- cromadas, resistentes à salinidade (MT1-H – MT1-L – MT2-SK1/C-SM1C)
- ASA branco, resistentes aos raios UV (SK1-SM1)
- Latão envernizado (TCE)
- Aço inoxidável (EM1-EM2-EM1/2-EMX1-EMX2-EMX1/2-DUCK HORN)
- ABS negro (BK1-BK2).

ELECTRIC HORNS

MT1-H



12V
24V

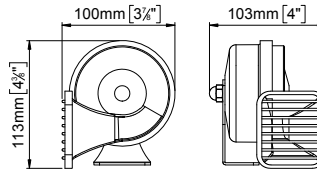

H 113 x L 100 x W 103 mm
H 4 3/8" x L 3 7/8" x W 4"

Features

- High tone
- Chrome plated

CODICE PART NUMBER	VOLT	AMP.	dB (A) (1m)	Hz	IMBALLO PACKING	Pcs. x carton
132 000 12	12	5	114	490	Box	40
132 000 13	24	3,5	114	490	Box	40

MT1-L



12V
24V

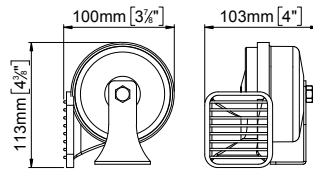

H 113 x L 100 x W 103 mm
H 4 3/8" x L 3 7/8" x W 4"

Features

- Low tone
- Chrome plated

CODICE PART NUMBER	VOLT	AMP.	dB (A) (1m)	Hz	IMBALLO PACKING	Pcs. x carton
132 001 12	12	5	114	410	Box	40
132 001 13	24	3,5	114	410	Box	40

MT2



12V
24V

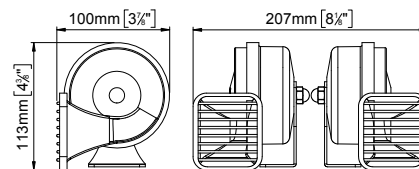

H 113 x L 100 x W 207 mm
H 4 3/8" x L 3 7/8" x W 8 1/8"

Features

- Two tuned sounds
- Chrome plated

CODICE PART NUMBER	VOLT	AMP.	dB (A) (1m)	Hz	IMBALLO PACKING	Pcs. x carton
132 020 12	12	10	116	410/490	Box	20
132 020 13	24	7	116	410/490	Box	20

EM1



12V
24V

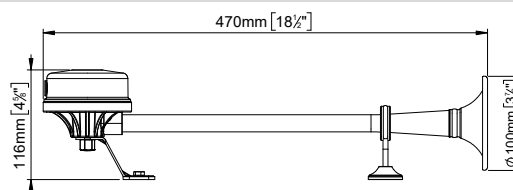

H 116 x L 470 x W 100 mm
H 4 5/8" x L 18 1/2" x W 3 7/8"

Features

- Low tone
- Stainless steel trumpet
- NMMA Approved

CODICE PART NUMBER	VOLT	LUNGHEZZA LENGTH mm	dB (A) (1m)	Hz	AMP.	IMBALLO PACKING	Pcs. x carton
132 041 12	12	470	118	320	5	Box	20
132 041 13	24	470	118	320	4	Box	20



EM2



12V
24V

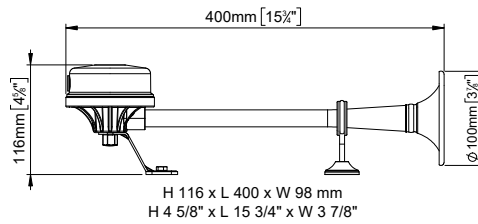

H 116 x L 400 x W 98 mm
H 4 5/8" x L 15 3/4" x W 3 7/8"

Features

- High tone
- Stainless steel trumpet

CODICE PART NUMBER	VOLT	LUNGHEZZA LENGTH mm	dB (A) (1m)	Hz	AMP.	IMBALLO PACKING	Pcs. x carton
132 040 12	12	400	118	370	5	Box	20
132 040 13	24	400	118	370	4	Box	20

EM1/2



12V
24V

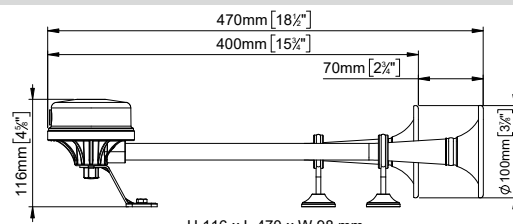

H 116 x L 470 x W 98 mm
H 4 5/8" x L 18 1/2" x W 3 7/8"

Features

- Two tuned sounds
- Stainless steel trumpet

CODICE PART NUMBER	VOLT	LUNGHEZZA LENGTH mm	dB (A) (1m)	Hz	AMP.	IMBALLO PACKING	Pcs. x carton
132 060 12	12	400/470	121	370/320	10	Box	6
132 060 13	24	400/470	121	370/320	8	Box	6

EMX1



12V
24V

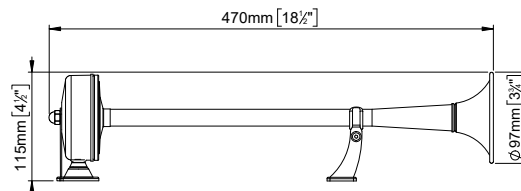

H 115 x L 470 x W 97 mm
H 4 1/2" x L 18 1/2" x W 3 3/4"

Features

- Low tone
- Hidden cable
- Completely stainless steel

CODICE PART NUMBER	VOLT	LUNGHEZZA LENGTH mm	dB (A) (1m)	Hz	AMP.	IMBALLO PACKING	Pcs. x carton
132 043 12	12	470	119	340	6	Box	20
132 043 13	24	470	119	340	3	Box	20

EMX2



12V
24V

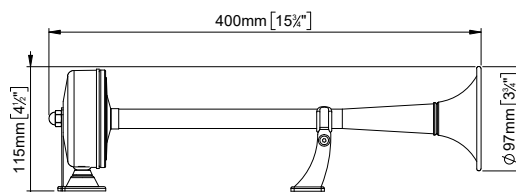

H 115 x L 400 x W 97 mm
H 4 1/2" x L 15 3/4" x W 3 3/4"

Features

- High tone
- Hidden cable
- Completely stainless steel

CODICE PART NUMBER	VOLT	LUNGHEZZA LENGTH mm	dB (A) (1m)	Hz	AMP.	IMBALLO PACKING	Pcs. x carton
132 042 12	12	400	119	370	6	Box	20
132 042 13	24	400	119	370	3	Box	20

EMX1/2



12V
24V

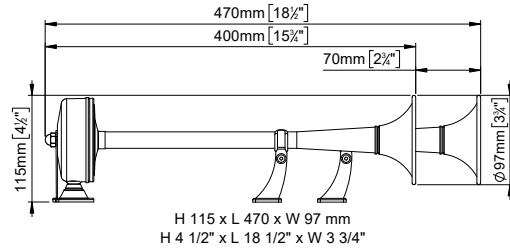

CODICE PART NUMBER	VOLT	LUNGHEZZA LENGTH mm	dB (A) (1m)	Hz	AMP.	IMBALLO PACKING	Pcs. x carton
132 061 12	12	400/470	122	370/340	12	Box	6
132 061 13	24	400/470	122	370/340	6	Box	6

Features

- Two tuned sounds
- Hidden cable
- Completely stainless steel
- NMMA Approved

DUCK



12V

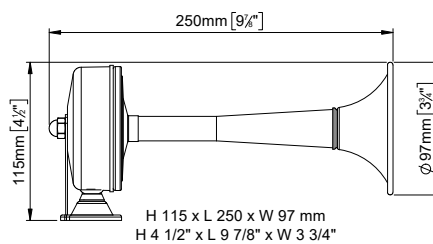

CODICE PART NUMBER	VOLT	LUNGHEZZA LENGTH mm	dB (A) (1m)	Hz	AMP.	IMBALLO PACKING	Pcs. x carton
132 140 12	12	250	114	570	5	Box	12

Features

- Hidden cable
- Completely stainless steel

TCE

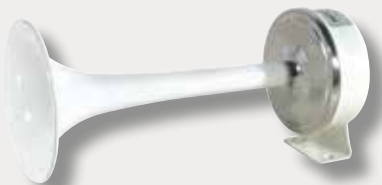

12V
24V

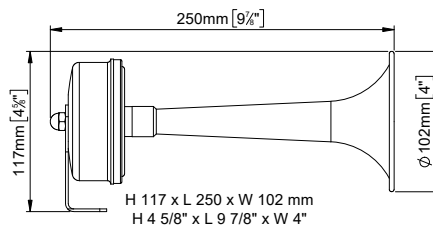

CODICE PART NUMBER	VOLT	LUNGHEZZA LENGTH mm	dB (A) (1m)	Hz	AMP.	IMBALLO PACKING	Pcs. x carton
132 120 12	12	250	114	570	5	Box	12
132 120 13	24	250	114	570	4	Box	12

Features

- White painted brass trumpet

BK1 BK2



6÷100V
9÷28V

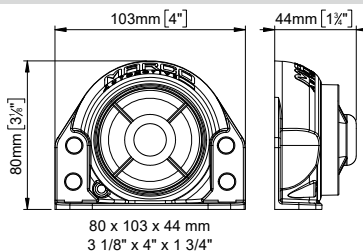

CODICE PART NUMBER	VOLT	DIMENSIONI DIMENSIONS mm	dB (A) (1m)	Hz	AMP.	IMBALLO PACKING	Pcs. x carton
104 120 15	6÷100	80 x 103 x 44	85/95	950/1850	0,1 - 0,3	Box	42
104 121 15	9÷28	80 x 103 x 44	100	1850	0,5	Box	42

Features

- Intermittent sound alarm for signaling on board
- IP67
- Electronic

SK1



12V

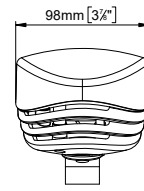
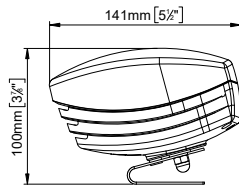

H 100 x L 141 x W 98
H 3 7/8" x L 5 1/2" x W 3 7/8"

Features

- Stainless steel bracket
- Draining holes
- UV resistant
- White ASA

CODICE PART NUMBER	VOLT	DIMENSIONI DIMENSIONS mm	dB (A) (1m)	Hz	AMP.	IMBALLO PACKING	Pcs. x carton
132 081 22	12	100 x 141 x 98	108	400	5	Blister	12

SK1/C



12V

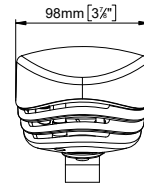
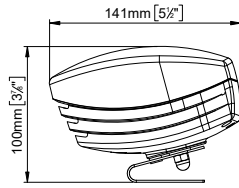

H 100 x L 141 x W 98
H 3 7/8" x L 5 1/2" x W 3 7/8"

Features

- Stainless steel bracket
- Draining holes
- Chromed ASA

CODICE PART NUMBER	VOLT	DIMENSIONI DIMENSIONS mm	dB (A) (1m)	Hz	AMP.	IMBALLO PACKING	Pcs. x carton
132 082 22	12	100 x 141 x 98	108	400	5	Blister	12

SM1



12V

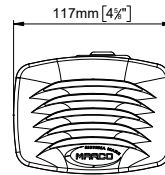
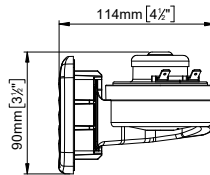

H 90 x L 114 x W 117
H 3 1/2" x L 4 1/2" x W 4 5/8"

Features

- Built-in quick fitting
- UV resistant
- White ASA
- NMMA Approved

CODICE PART NUMBER	VOLT	DIMENSIONI DIMENSIONS mm	dB (A) (1m)	Hz	AMP.	IMBALLO PACKING	Pcs. x carton
132 101 22	12	90 x 114 x 117	108	400	5	Blister	12

SM1/C



12V

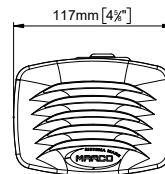
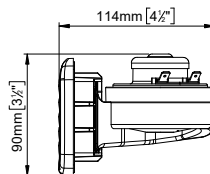

H 90 x L 114 x W 117
H 3 1/2" x L 4 1/2" x W 4 5/8"

Features

- Built-in quick fitting
- UV resistant
- Chromed ASA
- NMMA Approved

CODICE PART NUMBER	VOLT	DIMENSIONI DIMENSIONS mm	dB (A) (1m)	Hz	AMP.	IMBALLO PACKING	Pcs. x carton
132 102 22	12	90 x 114 x 117	108	400	5	Blister	12

SM1/B



12V

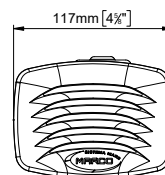
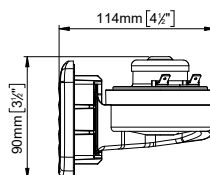

H 90 x L 114 x W 117
H 3 1/2" x L 4 1/2" x W 4 5/8"

Features

- Built-in quick fitting
- UV resistant
- Black ASA
- NMMA Approved

CODICE PART NUMBER	VOLT	DIMENSIONI DIMENSIONS mm	dB (A) (1m)	Hz	AMP.	IMBALLO PACKING	Pcs. x carton
132 103 22	12	90 x 114 x 117	108	400	5	Blister	12



IT Trombe elettropneumatiche con eccezionale potenza sonora disponibili nelle versioni:

- singola (MA1C-MA1S-TC1-TC1/P);
- bitonale (RIM-N/ TT2-M);
- ad incasso con compressore integrato (HR1-HR1/C).

Cornetto disponibile in: - ABS bianco o cromato; - ottone cromato; - ottone verniciato bianco.

Le griglie per versione ad incasso sono in ASA bianco o cromato.

Complete di compressore rinforzato, kit di montaggio, relè.

DE Elektropneumatische Hörner mit sehr starkem Klang, in folgenden Versionen erhältlich:

- Einzelhorn (MA1C-MA1S-TC1-TC1/P);
- Zweiton-Horn (RIM-N/ TT2-M);
- Einbautyp mit integriertem Kompressor (HR1-HR1/C).

Trichter aus: - weißem oder verchromtem ABS; - verchromtem Messing; - weiß lackiertem Messing.

Die Schutzgitter für die Einbauversion sind aus weißem oder verchromtem ASA.

Komplett mit verstärktem Kompressor, Montagekit und Relais.

FR Avertisseurs électropneumatiques avec un son très puissant, disponibles dans les versions suivantes :

- Seuls (MA1C-MA1S-TC1-TC1/P);
- Bitonal (RIM-N/ TT2-M);
- A' encastrer avec compresseur intégré (HR1-HR1/C).

Cornet disponible en: ABS blanc ou chromé, laiton chromé, laiton peint en blanc.

Les grilles pour les versions à encastrer sont en ASA blanc ou chromé.

Complètes avec compresseur, kit de montage, relais .

EN Electro-pneumatic horns with very powerful sound, available in the following versions:

- Single (MA1C-MA1S-TC1-TC1/P);
- Two-tone (RIM-N/ TT2-M);
- Built-in type with integrated compressor (HR1-HR1/C).

Trumpet in white or chromed ABS; - chromed brass ; - white-painted brass.

The grilles for the built-in types are in white or chromed ASA.

Complete with reinforced compressor, mounting kit, and relay.

ES Bocinas electro-neumáticas con sonido muy potente, disponibles en las siguientes versiones:

- Únicas (MA1C-MA1S-TC1-TC1/P);
- Bitonales (RIM-N/ TT2-M);
- Para empotrar, con compresor integrado (HR1-HR1/C).

Corneta disponible en : ABS blanco o cromado, latón cromado, latón pintado en blanco.

Las rejillas para las versiones empotradas son de ASA blanco o cromado.

Completas con compresor, kit de montaje, relé.

PT Buzinas electropneumáticas com sonido muito potente, disponíveis nas seguintes versões:

- Únicas (MA1C-MA1S-TC1-TC1/P);
- Bitonales (RIM-N/ TT2-M);
- De encaixe, com compressor integrado (HR1-HR1/C).

Corneta disponível em: - ABS branco ou cromado; - latão cromado; - latão pintado de branco.

As grelhas para as versões de encaixe são de ASA branco ou cromado.

Completas com compressor, kit de montagem, relé.

HR1



NMMA
TYPE ACCEPTED

12V
24V

HURRICANE

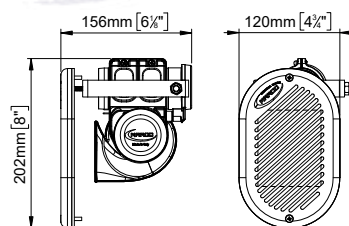

H 202 x L 156 x W 120
H 8" x L 6 1/8" x W 4 3/4"

Features

- Built-in quick fitting
- White ASA grille
- Integrated compressor

CODICE PART NUMBER	VOLT	dB (A) (1m)	Hz	AMP.	DIMENSIONI DIMENSIONS mm	IMBALLO PACKING	Pcs. x carton
134 080 12	12	120	300	20	202 x 156 x 120	Blister	12
134 080 13	24	120	300	11	202 x 156 x 120	Blister	12

HR1/C



NMMA
TYPE ACCEPTED

12V
24V

HURRICANE

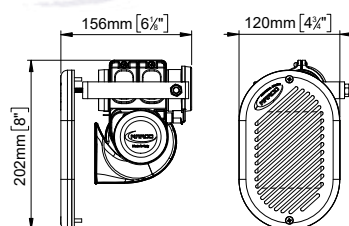

H 202 x L 156 x W 120
H 8" x L 6 1/8" x W 4 3/4"

Features

- Built-in quick fitting
- Chromed grille
- Integrated compressor

CODICE PART NUMBER	VOLT	dB (A) (1m)	Hz	AMP.	DIMENSIONI DIMENSIONS mm	IMBALLO PACKING	Pcs. x carton
134 081 12	12	120	300	20	202 x 156 x 120	Blister	12
134 081 13	24	120	300	11	202 x 156 x 120	Blister	12

MA1-C



12V
24V

HURRICANE

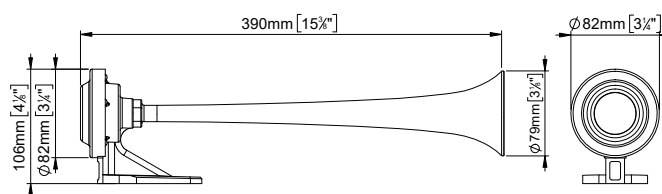

H 106 x L 390 x W 82
H 4 1/8" x L 15 3/8" x W 3 1/4"

Features

- Chromed plastic trumpet
- Compressor included

CODICE PART NUMBER	VOLT	LUNGHEZZA LENGTH mm	dB (A) (1m)	Hz	AMP.	IMBALLO PACKING	Pcs. x carton
134 000 12	12	390	114	326	20	Box	16
134 000 13	24	390	114	326	11	Box	16

MA1-S



NMMA
TYPE ACCEPTED

12V
24V

HURRICANE

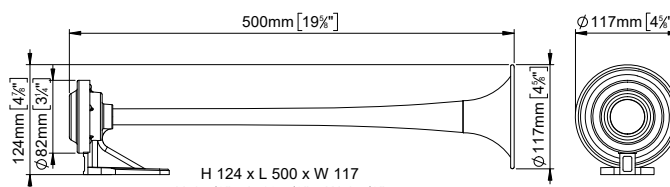

H 124 x L 500 x W 117
H 4 7/8" x L 19 3/8" x W 4 5/8"

Features

- Chromed brass trumpet
- Compressor included

CODICE PART NUMBER	VOLT	LUNGHEZZA LENGTH mm	dB (A) (1m)	Hz	AMP.	IMBALLO PACKING	Pcs. x carton
134 001 12	12	500	117	228	20	Box	12
134 001 13	24	500	117	228	11	Box	12

RIM-N



12V
24V

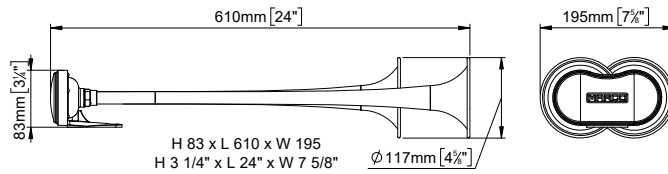

Features

- Chromed brass trumpet
- Compressor included
- One tuned sound
- NMMA Approved

CODICE PART NUMBER	VOLT	LUNGHEZZA LENGTH mm	dB (A) (1m)	Hz	AMP.	IMBALLO PACKING	Pcs. x carton
134 020 12	12	610	111	177/218	26	Box	5
134 020 13	24	610	111	177/218	13	Box	5

TT2-M



12V
24V

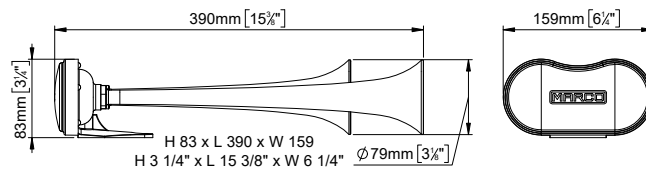

Features

- Plastic chromed horns
- Compressor included
- One tuned sound

CODICE PART NUMBER	VOLT	LUNGHEZZA LENGTH mm	dB (A) (1m)	Hz	AMP.	IMBALLO PACKING	Pcs. x carton
134 040 12	12	390	111	326/412	18	Box	12
134 040 13	24	390	111	326/412	9	Box	12

TC1/P



12V
24V

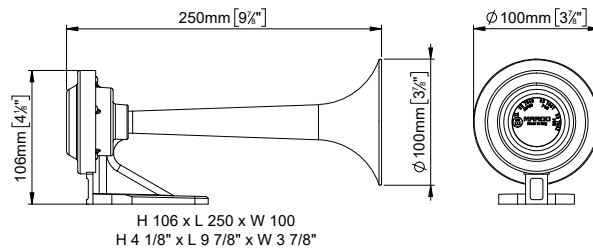

Features

- White ABS trumpet
- Compressor included

CODICE PART NUMBER	VOLT	LUNGHEZZA LENGTH mm	dB (A) (1m)	Hz	AMP.	IMBALLO PACKING	Pcs. x carton
134 061 12	12	250	116	420	16	Box	24
134 061 13	24	250	116	420	8	Box	24

M1



12V
24V

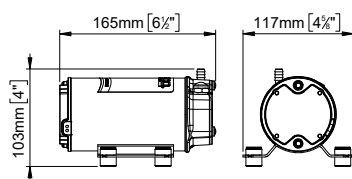

H 103 x L 165 x W 117
H 4" x L 6 1/2" x W 4 5/8"

Features

- Oil free
- Continuous duty cycles
- Barb fitting
- Suitable for RIM

PRESSIONE
PRESSURE
max.

2 bar 29 psi

CODICE PART NUMBER	VOLTS	MOTORE MOTOR	CORPO BODY	ROTORE ROTOR	DIMENSIONI DIMENSIONS mm	PESO WEIGHT
135 000 12	12	240W	Alluminio Aluminum	Alluminio Aluminum	103 x 165 x 117	2,4 kg
135 000 13	24	240W	Alluminio Aluminum	Alluminio Aluminum	103 x 165 x 117	2,4 kg

M2

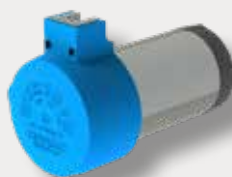

12V
24V

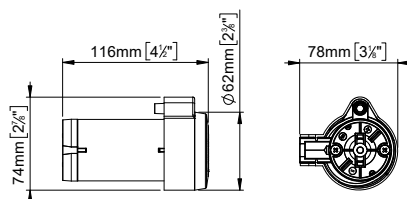

H 74 x L 116 x W 78
H 2 7/8" x L 4 1/2" x W 3 1/8"

Features

- Oil free
- R. 10 ECE-ONU

PRESSIONE
PRESSURE
max.

1 bar 14.5 psi

CODICE PART NUMBER	VOLTS	MOTORE MOTOR	CORPO BODY	ROTORE ROTOR	DIMENSIONI DIMENSIONS mm	PESO WEIGHT
113 100 02	12	240W	Alluminio Aluminum	POM	74 x 116 x 78	0,5 kg
113 100 03	24	264W	Alluminio Aluminum	POM	74 x 116 x 78	0,5 kg

MARCO HIGH TECH REVOLUTION:

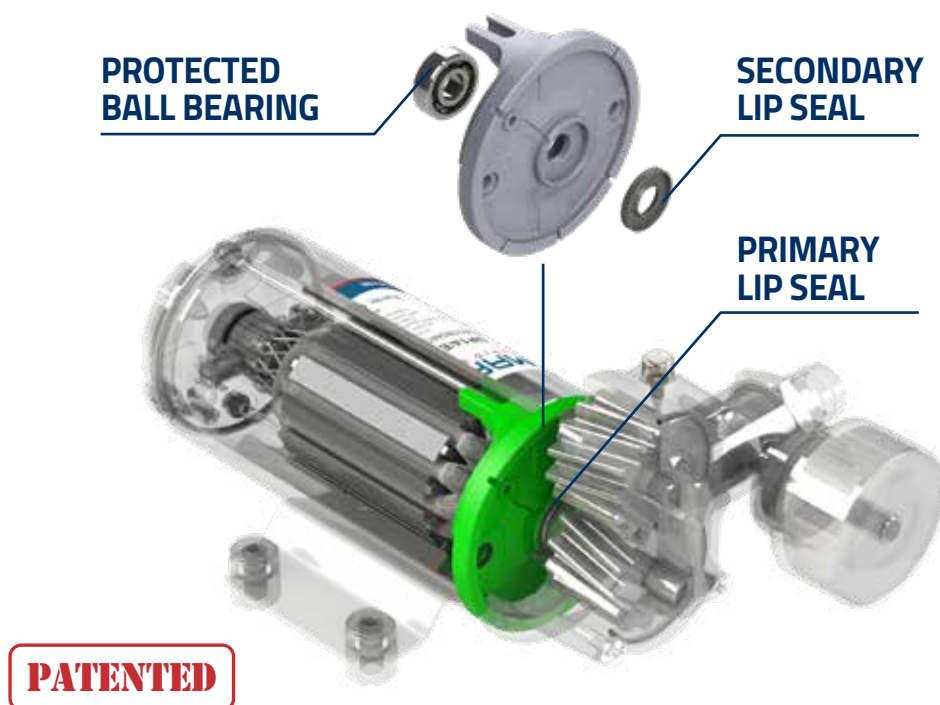

- Motore completamente sigillato e totale assenza di umidità, per una maggior durata delle spazzole e minor consumo elettrico.
- Elevate performance anche in condizioni climatiche di caldo e freddo estremi.
- Ampia tolleranza ai picchi di temperatura del fluido.
- Isolamento termico e meccanico per ridurre l'usura e prolungare la durata delle tenute.
- Alta resistenza ai prodotti chimici.
- Accoppiamento rigido ed allineato tra corpo pompa e motore.
- Sealed and dry motor for extended life of the brushes and lower electrical consumption.
- Enhanced motor protection.
- Best performances both in extreme hot and cold environments.
- Highly extended range of fluid temperature tolerance.
- Thermal and mechanical decoupling for reduced wear and extended seal life.
- Improved resistance to chemicals.
- Locked alignment of pump head.

3 TIMES LONGER OPERATIVE LIFE!

INTEGRATED FLANGE

PATENTED

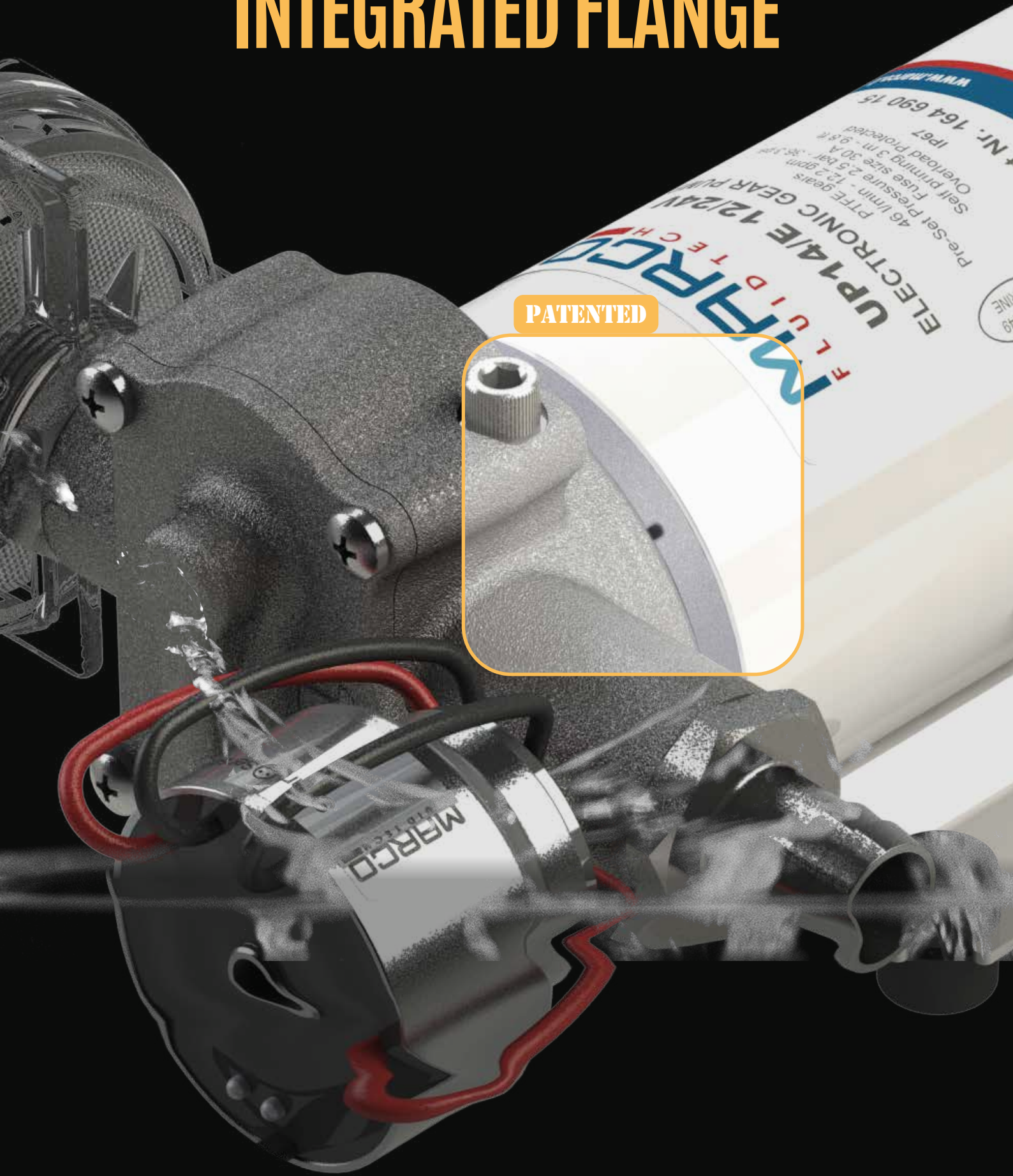

PEEK GEAR PUMPS

12V/24V Electronic Pressure Pumps

ELECTRONIC PRESSURE PUMPS

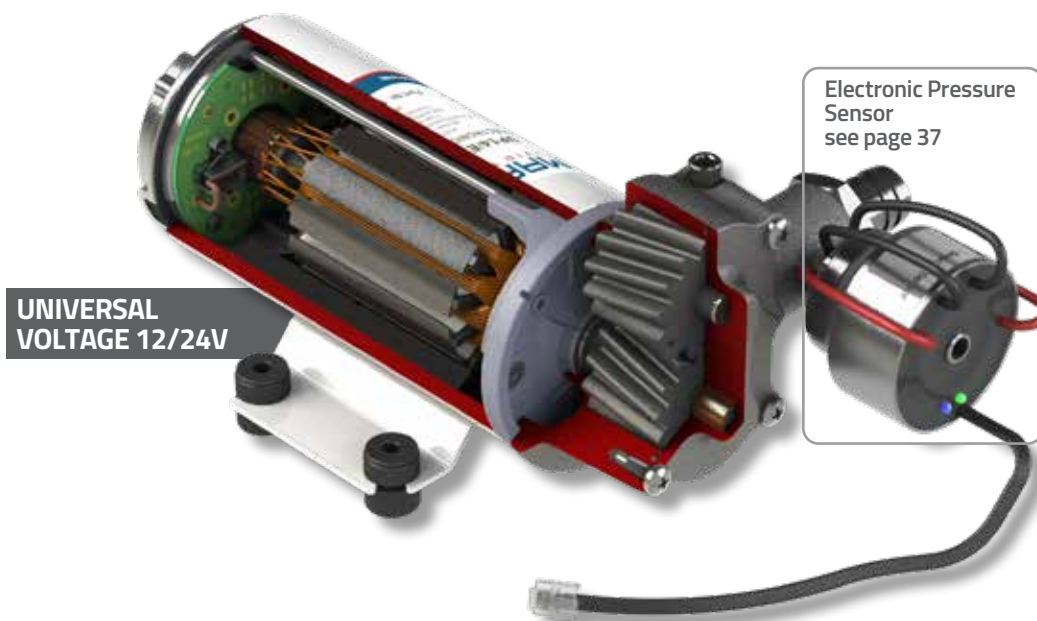

PEEK GEARS

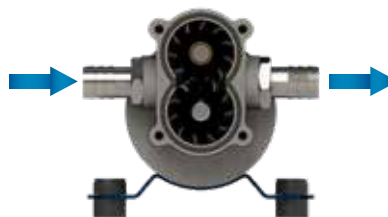
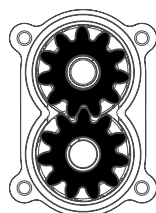

IT Elettropompe autoadescanti ad ingranaggi elicoidali in PEEK, voltaggio universale 12V/24V, valvola di non ritorno e sensore di pressione elettronico. Gli ingranaggi in PEEK garantiscono pressione costante, cicli di lavoro prolungati, maggiore silenziosità e ottima resistenza ad agenti chimici. Corpo e connessioni in ottone nichelato, albero in acciaio inossidabile, tenute in FKM e O-ring in NBR. Disponibili nella versione con pannello di controllo elettronico per gestione a distanza della pompa.

DE Selbstansaugende, PEEK-Schräg Zahnrad-Elektropumpen, 12V/24V Spannung, mit Rückschlagventil und elektronischem Drucksensor. Die PEEK-Zahnäder garantieren für einen konstanten Druck, für verlängerte Arbeitszyklen, Chemikalienresistenz und für verminderten Geräuschpegel. Gehäuse und Verbindungen aus vernickeltem Messing, Spindel aus rostfreiem Stahl, Dichtungen aus FKM und O-Ring aus NBR. Auch mit elektronischem Kontrollpaneel erhältlich.

FR Pompes électriques auto amorçantes avec engrenages hélicoïdaux en PEEK, tension universelle 12V / 24V, clapet anti-retour et capteur de pression électronique. Les engrenages en PEEK garantissent une pression constante, long cycles de travail, moins de bruit et une excellente résistance aux produits chimiques. Corps et raccords en laiton nickelé, arbre en acier inoxydable. Joint en FKM et O-Ring en NBR. Disponibles en version avec panneau de contrôle électronique pour la gestion à distance de la pompe.

EN Self-priming electric pumps with helical PEEK gears, universal voltage 12V / 24V, check valve and electronic pressure sensor. The PEEK gears guarantee constant pressure, heavy-duty cycles, lower noise levels and excellent resistance to chemicals. Body and nickel-plated brass connections, stainless steel shaft. FKM seals and NBR O-rings. Also available with electronic control panel for remote control.

ES Electrobombas eléctricas auto-cebadas con engranajes helicoidales en PEEK, voltaje universal 12V/24V, válvula de retención y sensor de presión electrónico. Los engranajes de PEEK garantizan una presión constante, largos ciclos de trabajo, niveles de ruido reducidos y una excelente resistencia a los productos químicos. Cuerpo y conexiones en latón niquelado, eje de acero inoxidable. Sellos en FKM y O-ring en NBR. Disponibles en versión con panel de control electrónico para la gestión remota de la bomba.

PT Eletrobombas auto-aspirantes com engrenagens helicoidais em PEEK, tensão universal 12V / 24V, válvula de retenção e sensor de pressão eletrônico. As engrenagens de PEEK garantem uma pressão constante, longos ciclos de trabalho, baixos níveis de ruído e excelente resistência à produtos químicos. Corpo e ligações em latão niquelado, eixo em aço inox, selos em FKM e O-ring em NBR. Disponíveis na versão com painel de controle eletrônico para a gestão remota da bomba.

ELECTRONIC PRESSURE PUMPS

12V/24V - DC

UP2/E



12/24V

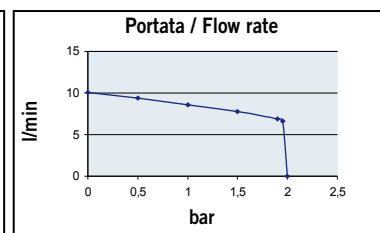
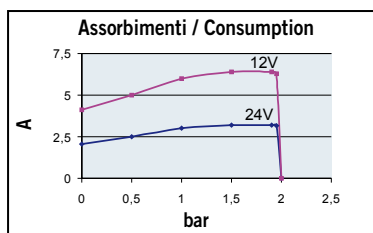
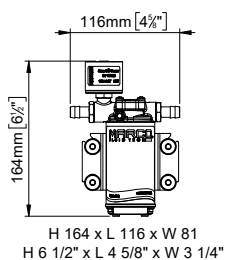

PORTATA
FLOW RATE
max.

PRESSIONE
PRESSURE
max.

10 l/min
2.6 gpm

2 bar
29 psi

CODICE
PART NUMBER

VOLTS

ADESCAM.
SELF-PRIM.
m

CONS.

MOTORE
MOTOR

FUSIBILE
FUZE

TUBO
TUBE

BOCCHIE
PORTS

PESO
WEIGHT

164 660 15 12/24

1,5

3A / 1,5A

90W

7,5A

12 mm

3/8" BSPP

1,3 kg

UP3/E



OPTIONAL

PCS Control Panel (page 38)



12/24V

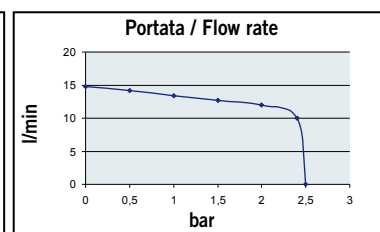
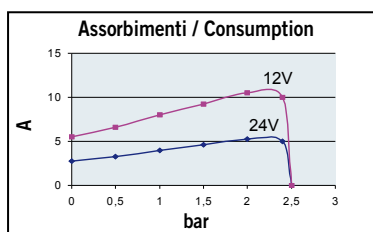
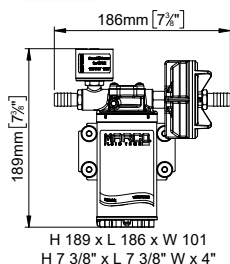

PORTATA
FLOW RATE
max.

PRESSIONE
PRESSURE
max.

15 l/min
4 gpm

2,5 bar
36 psi

CODICE
PART NUMBER

VOLTS

ADESCAM.
SELF-PRIM.
m

CONS.

MOTORE
MOTOR

FUSIBILE
FUZE

TUBO
TUBE

BOCCHIE
PORTS

PESO
WEIGHT

164 602 15 12/24

1,5

6A / 3A

150W

15A

13 mm

3/8" BSPP

2 kg

UP6/E



OPTIONAL

PCS Control Panel (page 38)



12/24V

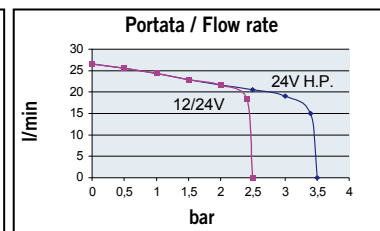
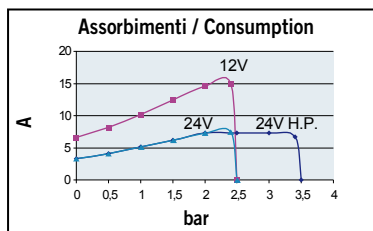
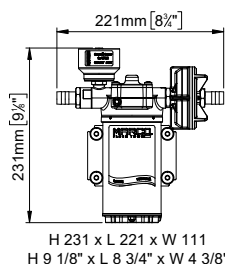

PORTATA
FLOW RATE
max.

PRESSIONE
PRESSURE
max.

26 l/min
6.9 gpm

2,5 bar
36 psi

CODICE
PART NUMBER

VOLTS

ADESCAM.
SELF-PRIM.
m

CONS.

MOTORE
MOTOR

FUSIBILE
FUZE

TUBO
TUBE

BOCCHIE
PORTS

PESO
WEIGHT

164 622 15 12/24

1,5

10A / 5A

180W

20A

16 mm

1/2" BSPP

3,7 kg

164 622 13 24

1,5

5A

180W

10A

16 mm

1/2" BSPP

3,7 kg

HIGH
PRESSURE

3,5 bar
50.8 psi

UP12/E



12/24V



OPTIONAL

PCS Control Panel (page 38)

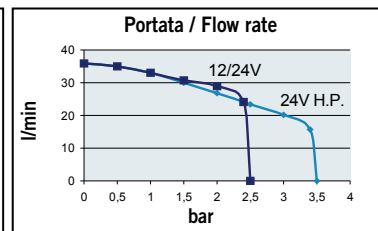
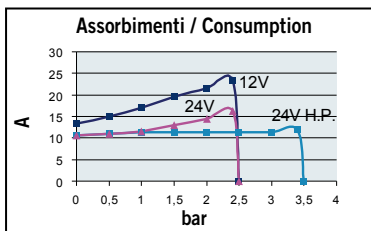
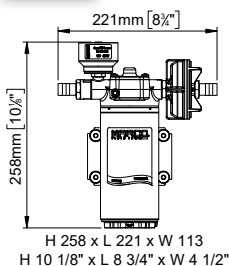

PORTATA FLOW RATE max.	PRESSIONE PRESSURE max.
36 l/min 9.5 gpm	2,5 bar 36 psi
HIGH PRESSURE	3,5 bar 50.8 psi

CODICE PART NUMBER	VOLTS	ADESCAM. SELF-PRIM. m	CONS.	MOTORE MOTOR	FUSIBILE FUSE	TUBO TUBE	BOCCHE PORTS	PESO WEIGHT
164 681 15	12/24	3	14A / 7A	360W	25A	16 mm	1/2" BSPP	4,9 kg
164 681 13	24	3	7A	360W	15A	16 mm	1/2" BSPP	4,9 kg

UP12/E-LO



12/24V



OPTIONAL

PCS Control Panel (page 38)

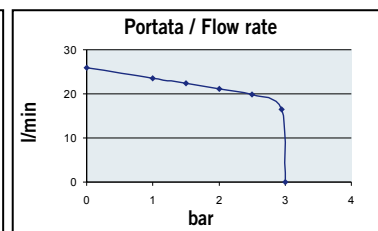
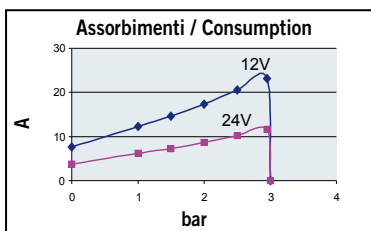
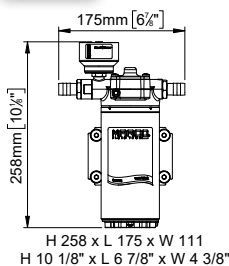

PORTATA FLOW RATE max.	PRESSIONE PRESSURE max.
26 l/min 6.9 gpm	3 bar 43.5 psi

CODICE PART NUMBER	VOLTS	ADESCAM. SELF-PRIM. m	CONS.	MOTORE MOTOR	FUSIBILE FUSE	TUBO TUBE	BOCCHE PORTS	PESO WEIGHT
164 687 15	12/24	3	14A / 7A	360W	25A	16 mm	1/2" BSPP	4,9 kg

UP14/E



12/24V



INCLUDED

PCS Control Panel (page 38)

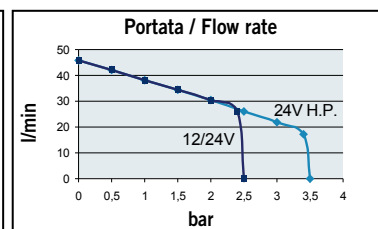
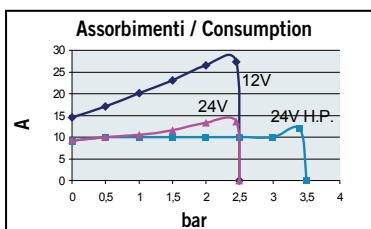
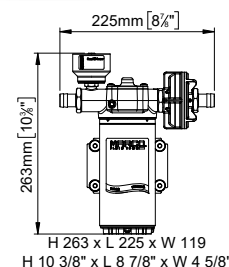

PORTATA FLOW RATE max.	PRESSIONE PRESSURE max.
46 l/min 12.2 gpm	2,5 bar 36 psi
HIGH PRESSURE	3,5 bar 50.8 psi

CODICE PART NUMBER	VOLTS	ADESCAM. SELF-PRIM. m	CONS.	MOTORE MOTOR	FUSIBILE FUSE	TUBO TUBE	BOCCHE PORTS	PESO WEIGHT
164 690 15	12/24	3	18A / 9A	400W	30A	19 mm	3/4" BSPP	5,2 kg
164 690 13	24	3	9A	400W	15A	19 mm	3/4" BSPP	5,2 kg

UP6/E-DX



INCLUDED

PCS Control Panel (page 38)

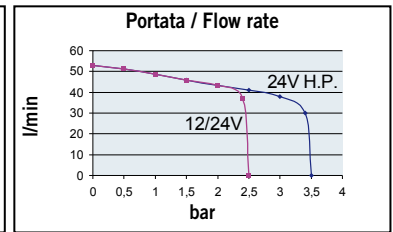
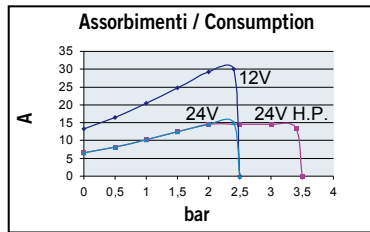
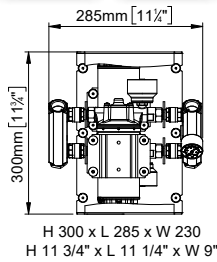

12/24V

PORTATA FLOW RATE max.	PRESSIONE PRESSURE max.
52 l/min <i>13.7 gpm</i>	2,5 bar <i>36 psi</i>
HIGH PRESSURE	3,5 bar <i>50.8 psi</i>

CODICE PART NUMBER	VOLTS	ADESCAM. SELF-PRIM. m	CONS.	MOTORE MOTOR	FUSIBILE FUSE	BOCCHIE PORTS	PESO WEIGHT
164 624 15	12/24	1,5	16A / 8A	2 x 180W	40A	3/4" BSPP	11 kg
164 624 13	24	1,5	8A	2 x 180W	20A	3/4" BSPP	11 kg

UP66/E-DX



INCLUDED

PCS Control Panel (page 38)

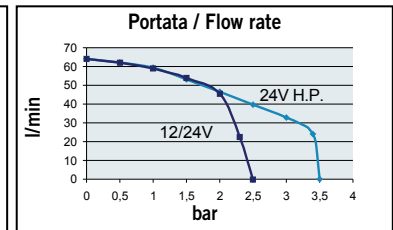
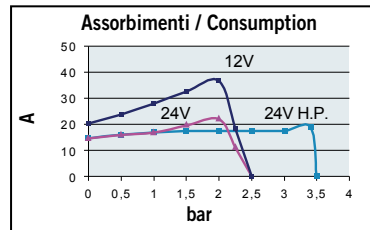
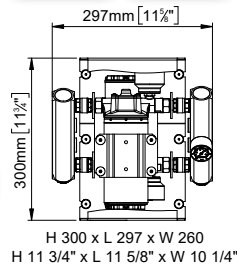

12/24V

PORTATA FLOW RATE max.	PRESSIONE PRESSURE max.
66 l/min <i>17.4 gpm</i>	2,5 bar <i>36.3 psi</i>
HIGH PRESSURE	3,5 bar <i>50.8 psi</i>

CODICE PART NUMBER	VOLTS	ADESCAM. SELF-PRIM. m	CONS.	MOTORE MOTOR	FUSIBILE FUSE	BOCCHIE PORTS	PESO WEIGHT
164 627 15	12/24	2	20A / 15A	1 x 180W 1 x 360W	50A	3/4" BSPP	13 kg
164 627 13	24	2	15A	1 x 180W 1 x 360W	25A	3/4" BSPP	13 kg

UP12/E-DX



INCLUDED

PCS Control Panel (page 38)

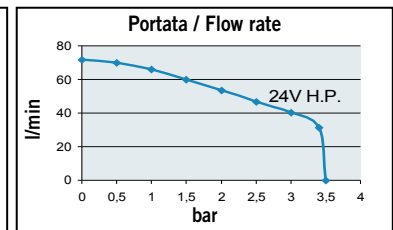
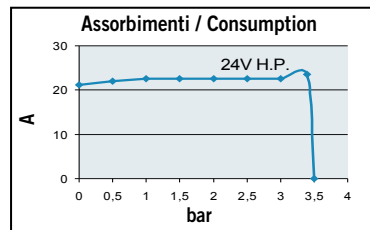
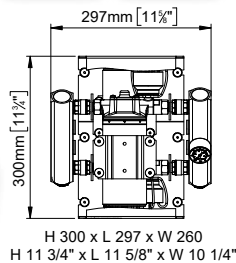

24V

PORTATA FLOW RATE max.	PRESSIONE PRESSURE max.
72 l/min <i>19 gpm</i>	2,5 bar <i>36.3 psi</i>
HIGH PRESSURE	3,5 bar <i>50.8 psi</i>

CODICE PART NUMBER	VOLTS	ADESCAM. SELF-PRIM. m	CONS.	MOTORE MOTOR	FUSIBILE FUSE	BOCCHIE PORTS	PESO WEIGHT
164 685 13	24	3	20A	2 x 360W	40A	1" BSPP	15 kg
164 686 13	24	3	20A	2 x 360W	30A	1" BSPP	15 kg

UP14/E-DX



INCLUDED

PCS Control Panel (page 38)



DUAL PUMPS

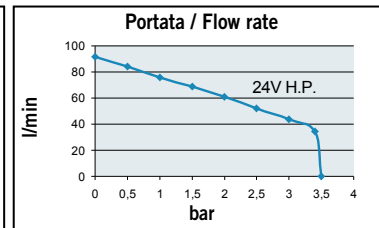
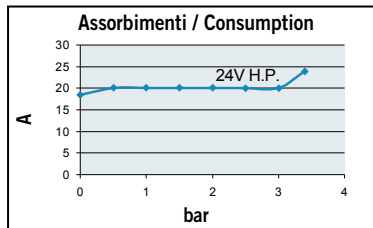
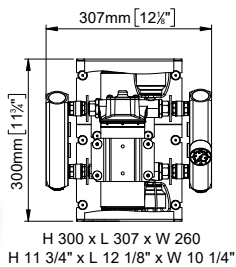

24V

PORTATA
FLOW RATE
max.

PRESSIONE
PRESSURE
max.

92 l/min
24.3 gpm

3,5 bar
50.8 psi

HIGH PRESSURE

CODICE PART NUMBER	VOLT	ADESCAM. SELF-PRIM. m	CONS.	MOTORE MOTOR	FUSIBILE FUSE	BOCCHIE PORTS	PESO WEIGHT
164 691 13	24	3	18A	2 x 400W	30A	1" BSPP	17 kg

UP8/E



OPTIONAL

PCS Control Panel (page 38)



12/24V

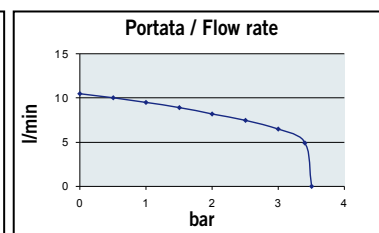
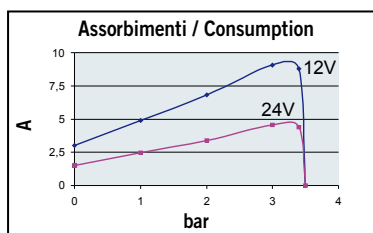
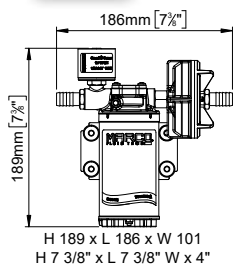

PORTATA
FLOW RATE
max.

PRESSIONE
PRESSURE
max.

10 l/min
2.6 gpm

3,5 bar
50.8 psi

HIGH PRESSURE

CODICE PART NUMBER	VOLTS	ADESCAM. SELF-PRIM. m	CONS.	MOTORE MOTOR	FUSIBILE FUSE	TUBO TUBE	BOCCHIE PORTS	PESO WEIGHT
164 635 15	12/24	1,5	4A / 2A	150W	15A	13 mm	3/8" BSPP	2,1 kg

UP9/E



OPTIONAL

PCS Control Panel (page 38)



12/24V

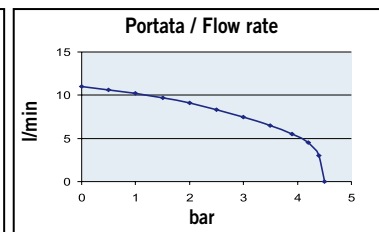
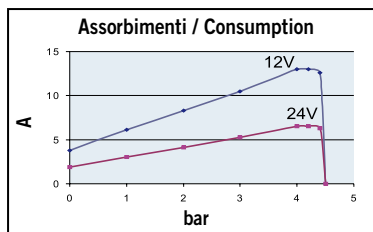
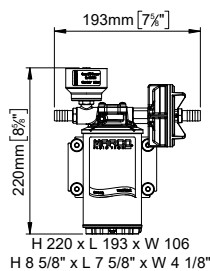

PORTATA
FLOW RATE
max.

PRESSIONE
PRESSURE
max.

12 l/min
3.2 gpm

4,5 bar
65.3 psi

HIGH PRESSURE

CODICE PART NUMBER	VOLTS	ADESCAM. SELF-PRIM. m	CONS.	MOTORE MOTOR	FUSIBILE FUSE	TUBO TUBE	BOCCHIE PORTS	PESO WEIGHT
164 642 15	12/24	1,5	5A / 2,5A	180W	15A	13 mm	3/8" BSPP	3,3 kg

UP10/E



12/24V



OPTIONAL

PCS Control Panel (page 38)

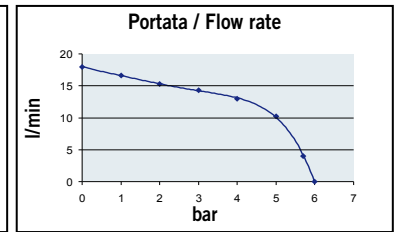
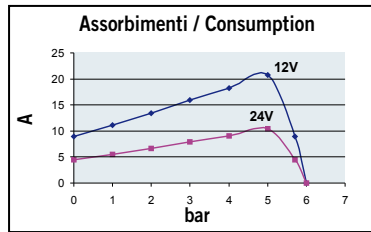
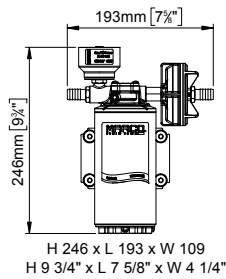

PORTATA
FLOW RATE
max.

18 l/min
4.8 gpm

PRESSIONE
PRESSURE
max.

6 bar
87 psi

HIGH PRESSURE

CODICE
PART NUMBER

164 404 15

VOLTS

12/24

ADESCAM.
SELF-PRIM.
m

3

CONS.

11A / 5,5A

MOTORE
MOTOR

360W

FUSIBILE
FUSE

25A

TUBO
TUBE

13 mm

BOCCH
E PORTS

3/8" BSPP

PESO
WEIGHT

4,3 kg

ELECTRONIC PRESSURE PUMP KITS

12V/24V - DC

SP2

Complete shower kit



12/24V



PORTATA
FLOW RATE
max.

10 l/min
2.6 gpm

PRESSIONE
PRESSURE
max.

2 bar
29 psi

CODICE
PART NUMBER

164 900 15

VOLTS

12/24

ADESCAM.
SELF-PRIM.
m

1,5

CONS.

3A / 1,5A

MOTORE
MOTOR

90W

FUSIBILE
FUSE

7,5A

TUBO
TUBE

12 mm

BOCCH
E PORTS

3/8" BSPP

PESO
WEIGHT

2,3 kg

TK1/2

TK2/2

Tank kit with electronic pump

Capability 107 or 67 liters

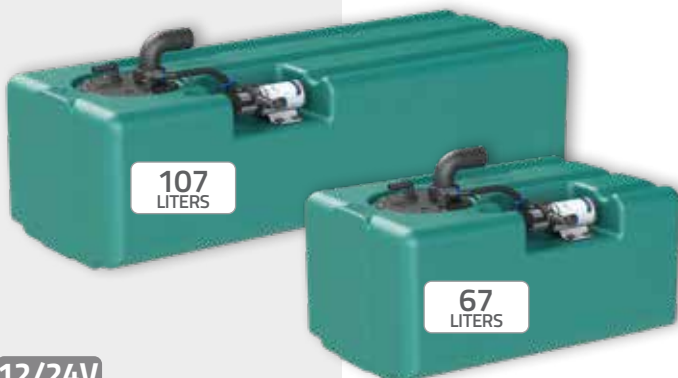

12/24V

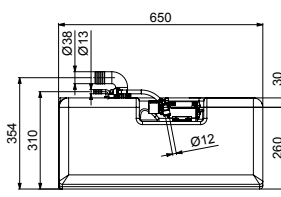
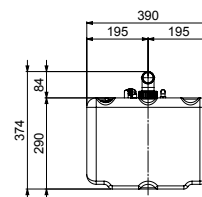
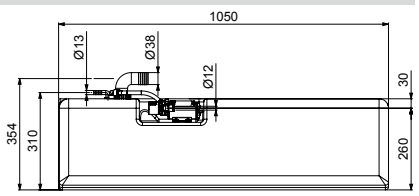
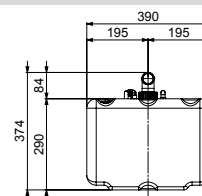

PORTATA
FLOW RATE
max.

10 l/min
2.6 gpm

PRESSIONE
PRESSURE
max.

2 bar
29 psi

CODICE
PART NUMBER

164 910 15

VOLTS

12/24

POMPA
PUMP

UP2/E

CAPACITA SERBATOIO
TANK CAPACITY
l

107

DIMENSIONI
DIMENSIONS
mm

1050 x 290 x 390

FUSIBILE
FUSE

7,5A

BOCCH
E PORTS

3/8" BSPP

164 911 15

12/24

UP2/E

67

650 x 290 x 390

7,5A

3/8" BSPP

ELECTRONIC PRESSURE PUMPS

ELECTRONIC DECK WASHING PUMPS 12V/24V - DC

DP3/E

▪ Wash down kit with 15m/50ft retractable hose



12/24V

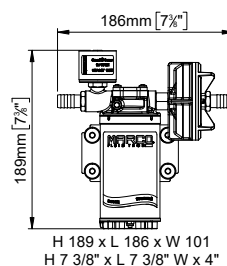

DQC Connection
see page 78



PORTATA
FLOW RATE
max.

PRESSIONE
PRESSURE
max.

CODICE
PART NUMBER

VOLTS

ADESCAM.
SELF-PRIM.
m

CONS.

MOTORE
MOTOR

FUSIBILE
FUZE

TUBO
TUBE

BOCCHE
PORTS

PESO
WEIGHT

14 l/min
3.7 gpm

3 bar
43.5 psi

164 801 15

12/24

1,5

10A

150W

15A

13 mm

3/8" BSPP

4,6 kg

DP9/E

▪ Wash down kit with 15m/50ft retractable hose



12/24V

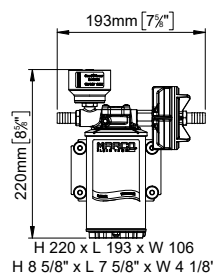

DQC Connection
see page 78



PORTATA
FLOW RATE
max.

PRESSIONE
PRESSURE
max.

CODICE
PART NUMBER

VOLTS

ADESCAM.
SELF-PRIM.
m

CONS.

MOTORE
MOTOR

FUSIBILE
FUZE

TUBO
TUBE

BOCCHE
PORTS

PESO
WEIGHT

12 l/min
3.2 gpm

4,5 bar
65.3 psi

HIGH PRESSURE

164 821 15

12/24

1,5

12A

180W

15A

13 mm

3/8" BSPP

4,6 kg

DP12/E

▪ Wash down kit with 15m/50ft retractable hose



12/24V

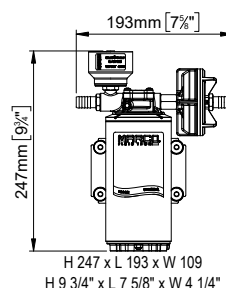

DQC Connection
see page 78



PORTATA
FLOW RATE
max.

PRESSIONE
PRESSURE
max.

CODICE
PART NUMBER

VOLTS

ADESCAM.
SELF-PRIM.
m

CONS.

MOTORE
MOTOR

FUSIBILE
FUZE

TUBO
TUBE

BOCCHE
PORTS

PESO
WEIGHT

15 l/min
4 gpm

6 bar
87 psi

HIGH PRESSURE

164 841 15

12/24

3

24A

360W

25A

13 mm

3/8" BSPP

5,5 kg

ELECTRONIC PRESSURE SENSOR

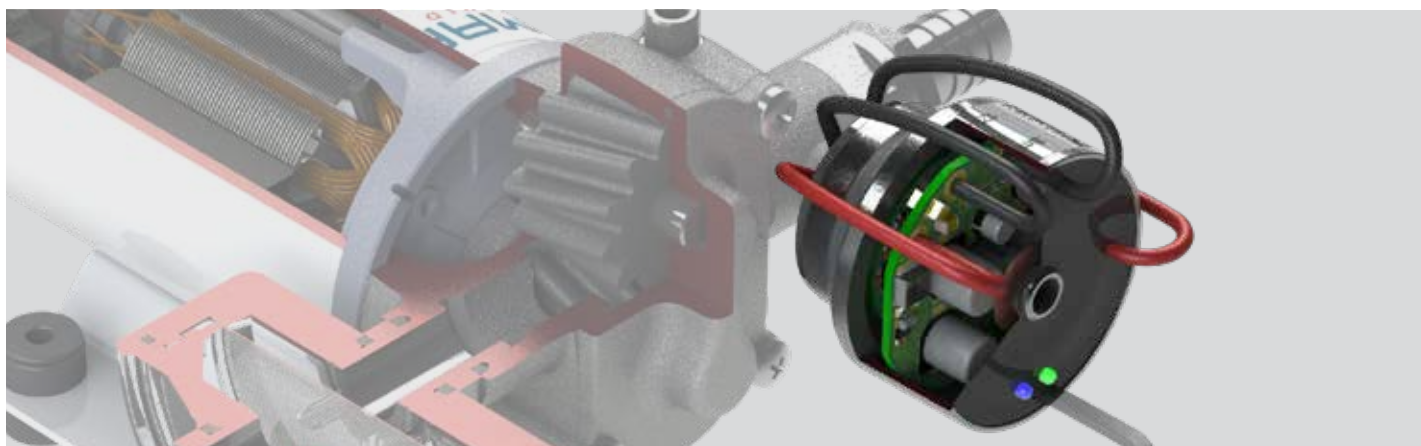

- IT** Il sensore di pressione elettronico regola la portata richiesta variando proporzionalmente i giri del motore e garantisce:
- Controllo costante di pressione, corrente e voltaggio
 - Protezione della pompa da cortocircuiti e sovratensioni
 - Arresto automatico in caso di fine liquido
 - Riduzione dei disturbi elettrici grazie all'accelerazione graduale del motore
 - Maggiore silenziosità
 - Ottimizzazione dei consumi di corrente
 - Minor usura dei componenti e maggior durata del sistema
 - Segnalazioni operative tramite LED luminosi

- EN** The electronic pressure sensor controls the requested flow rate by proportionally adapting the speed of the motor and guarantees:
- Constant control of pressure, voltage and electrical draw
 - Protection of the pump from short circuits and overvoltage
 - Automatic stop in case of no liquid
 - Reduction of electrical interferences thanks to the gradual acceleration of the motor
 - Noise reduction during operation
 - Optimization of electrical draw
 - Reduced wear of components and increased life of the system
 - Operative functions signaled by luminous LEDs

- DE** Der elektronische Drucksensor regelt die angeforderte Durchflussrate, indem er die Motordrehzahl anpasst und garantiert außerdem:
- Konstante Kontrolle von Druck, Strom und Spannung
 - Sichert die Pumpe gegen Kurzschlüssen und Überströmen
 - Automatische Stop-Funktion bei Flüssigkeitsmangel
 - Verminderung der elektrischen Störungen dank der graduellen Steigerung des Motors
 - Geräuschärmer
 - Optimierung des Stromverbrauchs
 - Reduzierung der mechanischen Verschleißteile und verlängerte Dauer des Systems
 - Betriebsfunktionen werden anhand von LED-Leuchten angezeigt

- FR** Le capteur de pression électronique contrôle le débit demandé en adaptant proportionnellement la vitesse du moteur et garantit:
- Contrôle constant de pression, tension et tirage électrique
 - Protection de la pompe contre les courts circuits et les surcharges
 - Arrêt automatique en cas de fin du liquide
 - Réduction des interférences électriques grâce à l'accélération progressive du moteur
 - Réduction du bruit pendant le fonctionnement
 - Optimisation du tirage électrique
 - Réduction de l'usure des composants et durée de vie accrue du système
 - Fonctions opérationnelles signalées par LEDs lumineuses

- ES** El sensor de presión electrónico controla el caudal requerido adaptando gradualmente la velocidad del motor y garantiza:
- Control constante de presión, corriente y voltaje
 - Protección de la bomba contra cortocircuitos y sobretensiones
 - Paro automático en caso de acabar el líquido
 - Reducción de los disturbios eléctricos gracias a la aceleración gradual del motor
 - Reducción del ruido durante el funcionamiento
 - Optimización del consumo eléctrico
 - Menor desgaste de los componentes y mayor duración de la vida del sistema
 - Condiciones operativas señaladas por LEDs luminosos

- PT** O sensor de pressão eletrónico controla o fluxo desejado adaptando gradualmente a velocidade do motor e garante:
- Controle constante de pressão, corrente e tensão
 - Proteção da bomba contra curtos-circuitos e sobretensões
 - Paragem automática em caso do líquido acabar
 - Redução das interferências elétricas graças à aceleração gradual do motor
 - Redução de ruído durante o funcionamento
 - Otimização do consumo de eletricidade
 - Desgaste reduzido dos componentes e maior duração do sistema
 - Condições de funcionamento indicadas pelos LEDs iluminados

PCS PUMP CONTROL SYSTEM

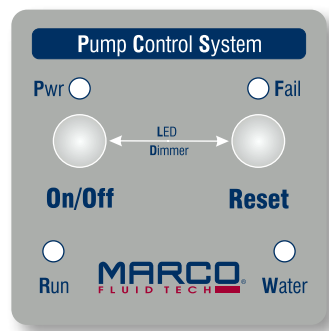

IT Il pannello di controllo PCS permette di monitorare a distanza il funzionamento della pompa ed interagire con essa.

Caratteristiche:

- Monitoraggio a distanza del funzionamento della pompa ed interazione con essa: verifica della presenza di liquido e reset in caso di malfunzionamento senza togliere l'alimentazione.
- Il LED "Run" segnala il funzionamento della pompa ed avvisa in caso di piccole perdite nell'impianto evitando danni al motore a causa del funzionamento prolungato a bassi giri.
- Arresto e riavvio della pompa con la semplice pressione di un tasto.
- Connessione rapida del pannello al cavo di 3m con attacco RJ11/6 integrato nel sensore della pompa.
- Possibilità di montaggio ad incasso con foro circolare di diametro 70mm o di montaggio esterno.
- Morsetteria che permette di replicare i pulsanti e i LED presenti sul pannello su un circuito esterno: questo permette di gestire in modo personalizzato le funzionalità su un dispositivo progettato da terze parti.

DE Das PCS Kontroll-Panel ermöglicht es, die elektronische Pumpe fern zu steuern und mit ihr zu interagieren.

Eigenschaften:

- Fernüberwachung des Pumpenlaufs und deren Fernsteuerung: kontrolliert das Vorhandensein von Flüssigkeit, bei Fehlbetrieb schaltet sich die Reset-Funktion ein, ohne alles ausschalten zu müssen.
- Das "Run" LED zeigt an, dass die Pumpe arbeitet und gibt eine Warnung an bei kleinen Wasserverlusten im System. Damit kann, bei längerem Betrieb mit niedrigen Umdrehungen, ein Motorschaden verhindert werden.
- Stoppen und Starten der Pumpe wird mit einem Knopfdruck betätigt.
- Schnellverbindung des Paneels an das 3m RJ11/6 Kabel, das in dem Pumpensensor integriert ist.
- Einbaumöglichkeit in rundem, 70mm- Durchmesser Loch oder externe Montage.
- Mit dem Verteiler kann man die Knöpfe und LEDs des Paneels auf einen externen Kreis wiedergeben: dieses ermöglicht eine individuelle Einstellung der Funktionen auf einer externen Vorrichtung, die von Dritten entworfen wurde.

FR Le panneau de contrôle PCS vous permet de surveiller à distance le fonctionnement de la pompe et d'interagir avec elle.

Les caractéristiques:

- Surveillance à distance du fonctionnement de la pompe et de l'interaction avec elle: vérification de la présence de liquide et réinitialisation en cas de dysfonctionnement sans débrancher l'appareil.
- Le LED "Run" indique que la pompe est en marche et donne l'alerte en cas de petites fuites dans le système, pour prévenir des dommages au moteur en raison d'un fonctionnement prolongé à faible vitesse.
- Arrêt et démarrage de la pompe avec une simple pression sur un bouton.
- Connexion rapide du panneau au câble de 3m avec terminal RJ11/6, intégré dans le capteur de la pompe.
- Le panneau peut être encastré dans un trou circulaire d'un diamètre de 70 mm ou monté à l'extérieur.
- Le bornier permet à l'utilisateur de reproduire les boutons et les LEDs du panneau sur un circuit externe favorisant ainsi une gestion personnalisée des fonctions grâce à un dispositif externe conçu par des tiers.

EN The PCS control panel allows you to remotely monitor the operation of the pump and interact with it.

Characteristics:

- Remote monitoring of the pump operation and interaction with it: checking of liquid presence and reset in case of malfunction without disconnecting the device.
- The "Run" LED indicates that the pump is working and alerts in case of small leaks in the system, preventing motor damage due to prolonged operation at low speed.
- Stop and Start of the pump with a simple push of a button.
- Quick connection of the panel to the 3m RJ11/6 terminal cable integrated in the sensor of the pump.
- The panel can be recessed in a circular hole of a 70mm diameter or externally mounted.
- The terminal block allows the user to replicate the buttons and leds of the panel on an external circuit thus favoring a personalized management of the functions through an external device designed by third parties.

ES El panel de control PCS permite controlar a distancia el funcionamiento de la bomba e interactuar con ella.

Características:

- Monitorización remota del funcionamiento de la bomba e interacción con ella: comprobación de la presencia de líquido y reinicio en caso de avería sin necesidad de desconectar el dispositivo.
- El LED « Run » indica que de la bomba está funcionando y avisa en caso de pequeñas fugas en el sistema, para prevenir daños en el motor debido al funcionamiento prolongado a baja velocidad.
- Apagamiento e reinicio de la bomba con una simple pulsación de un botón.
- Conexión rápida del panel al cable de 3m con terminal RJ11 / 6, integrado en el sensor de la bomba.
- El panel puede ser empotrado dentro de un orificio circular de un diámetro de 70 mm o montado externamente.
- El bloque de terminales permite al usuario reproducir los botones y LEDs del panel en un circuito externo: esto permite una gestión personalizada de las funciones a través de un dispositivo externo diseñado por terceros.

PT O painel de controle PCS permite monitorar remotamente o funcionamento da bomba e interagir com a mesma.

Características:

- Monitoramento remoto da operação da bomba e interação com a mesma: verificação da presença de líquido e reinício em caso de funcionamento defeituoso sem desligar o dispositivo.
- O LED "Run" indica que a bomba está funcionando e alerta em caso de pequenas fugas no sistema, para evitar danos no motor devido a um funcionamento prolongado a baixa velocidade.
- Paragem e arranque da bomba com uma simples pressão dum botão.
- Ligação rápida do painel ao cabo de 3m com terminal RJ11 / 6, integrado no sensor da bomba.
- O painel pode ser embutido num orifício circular com um diâmetro de 70 mm ou montado externamente.
- Um bloco de terminais permite replicar os botões e LEDs do painel num circuito externo: isto permite controlar individualmente as funções num dispositivo projetado por terceiros.

TIPO TYPE	CODICE PART NUMBER	VOLT	PROTEZIONE PROTECTION	DIMENSIONI DIMENSIONS mm	FORO HOLE mm	CONNESSIONE CONNECTION
PCS	165 203 15	12/24	IP65	80 x 80 x 46	Ø 70	RJ11

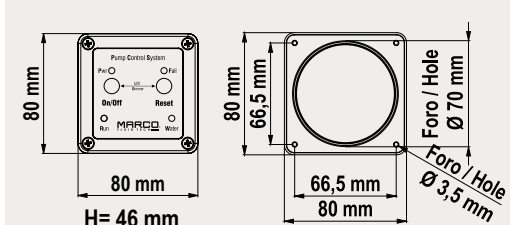

PEEK GEAR PUMPS

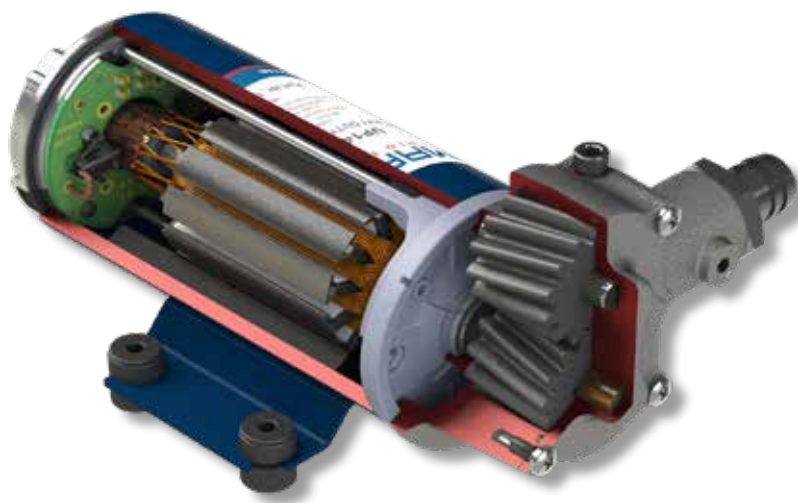

PEEK GEARS

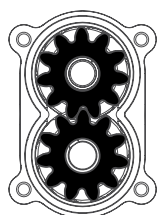

IT Elettropompe autoadescanti ad ingranaggi elicoidali in PEEK per travaso acqua e liquidi a bassa viscosità. Gli ingranaggi in PEEK garantiscono pressione costante, cicli di lavoro prolungati, maggiore silenziosità e ottima resistenza ad agenti chimici. Corpo in ottone nichelato, albero in acciaio inossidabile e tenuta in FKM se non diversamente specificato. Disponibili in versioni con filtro in linea, valvola di non ritorno, pressostato meccanico, sensore di pressione elettronico e kit per applicazioni varie.

DE Selbstansaugende Elektropumpen mit PEEK-Schrägzahnrädern. Die PEEK-Zahnräder garantieren für einen konstanten Druck, für verlängerte Arbeitszyklen, Chemikalienresistenz und für verminderten Geräuschpegel. Gehäuse aus vernickeltem Messing, Spindel aus rostfreiem Stahl, Dichtung aus FKM, falls nicht anders angegeben. Modelle lieferbar mit In-Line-Filter, Rückschlagventil, mechanischem Druckwächter, elektronischem Drucksensor sowie Montageset für verschiedene Anwendungen.

FR Pompes électriques auto amorçantes avec des engrenages hélicoïdaux de PEEK pour le transfert de l'eau et des liquides à faible viscosité. Les engrenages en PEEK garantissent une pression constante, long cycles de travail, moins de bruit et une excellente résistance aux produits chimiques. Corps en laiton nickelé, arbre en acier inoxydable et joint en FKM, sauf indication contraire. Disponibles dans les versions avec filtre en ligne, clapet anti-retour, interrupteur de pression mécanique, capteur de pression électronique et des kits pour applications différentes.

EN Self priming electric pumps with helical PEEK gears for the transfer of water and liquids with low viscosity. The PEEK gears guarantee constant pressure, heavy-duty cycles, lower noise levels and excellent resistance to chemicals. Nickel-plated brass body, stainless steel shaft and FKM seal unless otherwise specified. Available in versions with in-line filter, integrated check valve, mechanical pressure switch, electronic pressure sensor and kits for various applications.

ES Bombas eléctricas auto-cebadas con engranajes helicoidales en PEEK para la transferencia de agua y líquidos de baja viscosidad. Los engranajes de PEEK garantizan una presión constante, largos ciclos de trabajo, niveles de ruido reducidos y una excelente resistencia a los productos químicos. Cuerpo en latón niquelado, eje de acero inoxidable y junta de FKM si no diferentemente especificado. Disponible en versiones con filtro en línea, válvula de retención, interruptor de presión mecánico, sensor de presión electrónico y kits para diversas aplicaciones.

PT Bombas com engrenagens helicoidais em PEEK para a transferência de água e líquidos de baixa viscosidade. As engrenagens de PEEK garantem uma pressão constante, longos ciclos de trabalho, baixos níveis de ruído e excelente resistência aos produtos químicos. Corpo em latão niquelado, eixo em aço inox e junta em FKM salvo indicação diferente. Disponíveis em versões com filtro em linha, válvula anti-retorno, interruptor de pressão mecânico, sensor de pressão eletrónico e kits para várias aplicações.

PEEK GEARS

12V and 24V - DC

UP2-P



12V

24V

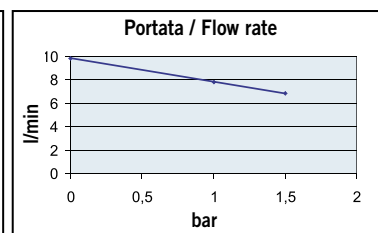
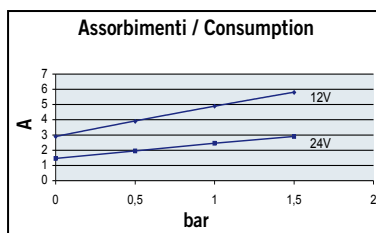
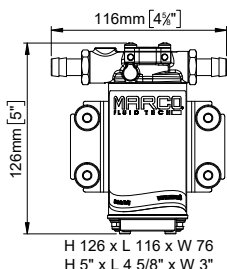

PORTATA FLOW RATE max.	PRESSIONE PRESSURE max.
10 l/min 2.6 gpm	1,5 bar 22 psi

CODICE PART NUMBER	VOLTS	ADESCAM. SELF-PRIM. m	CONS.	MOTORE MOTOR	FUSIBILE FUSE	TUBO TUBE	BOCCHIE PORTS	PESO WEIGHT
164 202 12	12	1,5	3A	90W	5A	12 mm	3/8" BSPP	1,2 kg
164 202 13	24	1,5	1,5A	90W	3A	12 mm	3/8" BSPP	1,2 kg

UP2-PV

▪ Integrated check valve



12V

24V

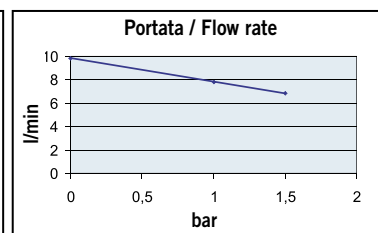
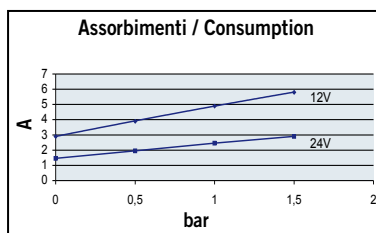
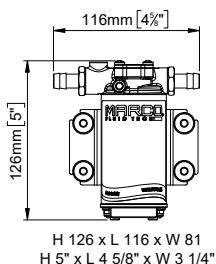

PORTATA FLOW RATE max.	PRESSIONE PRESSURE max.
10 l/min 2.6 gpm	1,5 bar 22 psi

CODICE PART NUMBER	VOLTS	ADESCAM. SELF-PRIM. m	CONS.	MOTORE MOTOR	FUSIBILE FUSE	TUBO TUBE	BOCCHIE PORTS	PESO WEIGHT
164 204 12	12	1,5	3A	90W	5A	12 mm	3/8" BSPP	1,2 kg
164 204 13	24	1,5	1,5A	90W	3A	12 mm	3/8" BSPP	1,2 kg

UP3-P



12V

24V

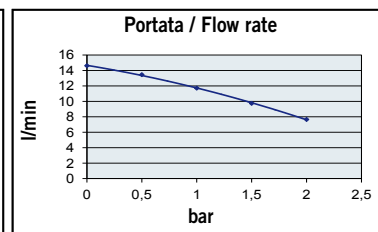
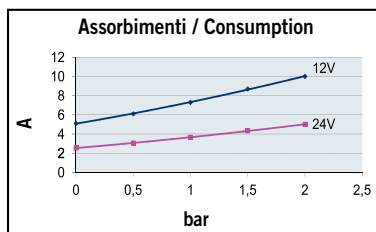
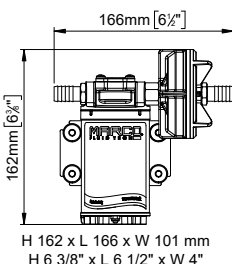

PORTATA FLOW RATE max.	PRESSIONE PRESSURE max.
15 l/min 4 gpm	2 bar 29 psi

CODICE PART NUMBER	VOLTS	ADESCAM. SELF-PRIM. m	CONS.	MOTORE MOTOR	FUSIBILE FUSE	TUBO TUBE	BOCCHIE PORTS	PESO WEIGHT
164 002 12	12	1,5	6A	120W	10A	13 mm	3/8" BSPP	1,6 kg
164 002 13	24	1,5	3A	120W	5A	13 mm	3/8" BSPP	1,6 kg

UP3-PV

▪ Integrated check valve



12V
24V

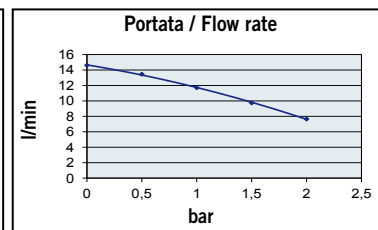
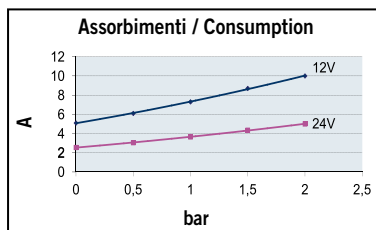
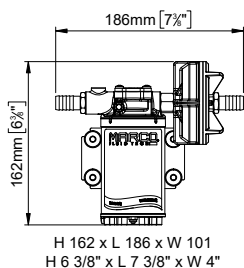

PORTATA FLOW RATE max.	PRESSIONE PRESSURE max.
15 l/min 4 gpm	2 bar 29 psi

CODICE PART NUMBER	VOLTS	ADESCAM. SELF-PRIM. m	CONS.	MOTORE MOTOR	FUSIBILE FUSE	TUBO TUBE	BOCCHIE PORTS	PESO WEIGHT
164 004 12	12	1,5	6A	120W	10A	13 mm	3/8" BSPP	1,6 kg
164 004 13	24	1,5	3A	120W	5A	13 mm	3/8" BSPP	1,6 kg

UP6-P



12V
24V

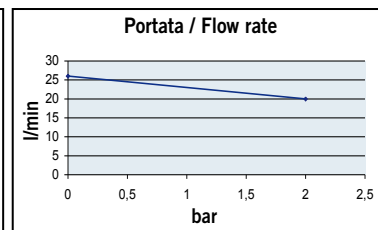
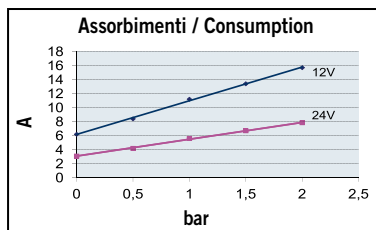
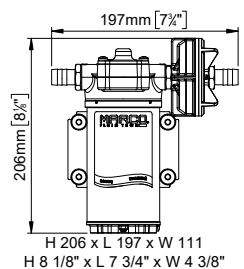

PORTATA FLOW RATE max.	PRESSIONE PRESSURE max.
26 l/min 6.9 gpm	2 bar 29 psi

CODICE PART NUMBER	VOLTS	ADESCAM. SELF-PRIM. m	CONS.	MOTORE MOTOR	FUSIBILE FUSE	TUBO TUBE	BOCCHIE PORTS	PESO WEIGHT
164 065 12	12	1,5	10A	180W	15A	16 mm	1/2" BSPP	3,1 kg
164 065 13	24	1,5	5A	180W	7,5A	16 mm	1/2" BSPP	3,1 kg

UP6-PV

▪ Integrated check valve



12V
24V

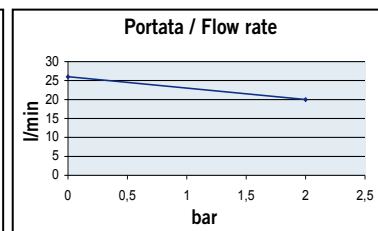
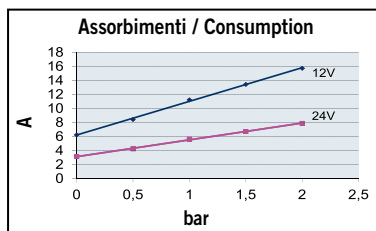
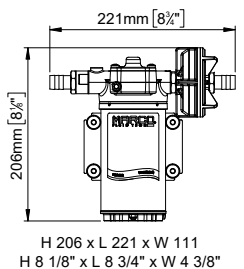

PORTATA FLOW RATE max.	PRESSIONE PRESSURE max.
26 l/min 6.9 gpm	2 bar 29 psi

CODICE PART NUMBER	VOLTS	ADESCAM. SELF-PRIM. m	CONS.	MOTORE MOTOR	FUSIBILE FUSE	TUBO TUBE	BOCCHIE PORTS	PESO WEIGHT
164 063 12	12	1,5	10A	180W	15A	16 mm	1/2" BSPP	3,4 kg
164 063 13	24	1,5	5A	180W	7,5A	16 mm	1/2" BSPP	3,4 kg

UP12-P



12V
24V

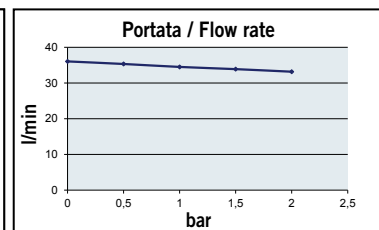
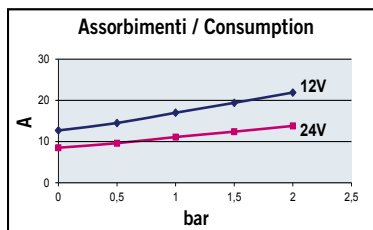
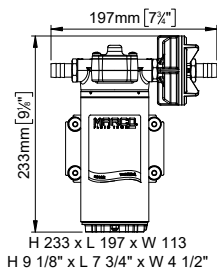

PORTATA
FLOW RATE
max. **36 l/min**
9.5 gpm

PRESSIONE
PRESSURE
max. **2 bar**
29 psi

CODICE PART NUMBER	VOLTS	ADESCAM. SELF-PRIM. m	CONS.	MOTORE MOTOR	FUSIBILE FUSE	TUBO TUBE	BOCCHIE PORTS	PESO WEIGHT
164 302 12	12	3	14A	360W	20A	16 mm	1/2" BSPP	4,3 kg
164 302 13	24	3	8A	360W	15A	16 mm	1/2" BSPP	4,3 kg

UP12-PV

▪ Integrated check valve



12V
24V

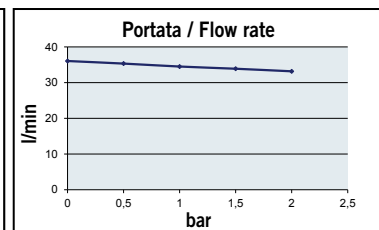
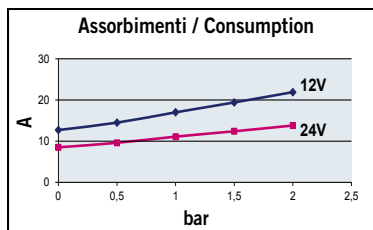
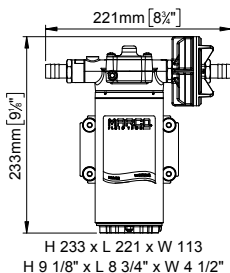

PORTATA
FLOW RATE
max. **36 l/min**
9.5 gpm

PRESSIONE
PRESSURE
max. **2 bar**
29 psi

CODICE PART NUMBER	VOLTS	ADESCAM. SELF-PRIM. m	CONS.	MOTORE MOTOR	FUSIBILE FUSE	TUBO TUBE	BOCCHIE PORTS	PESO WEIGHT
164 304 12	12	3	14A	360W	20A	16 mm	1/2" BSPP	4,3 kg
164 304 13	24	3	8A	360W	15A	16 mm	1/2" BSPP	4,3 kg

UP14-P

▪ High flow rate



12V
24V

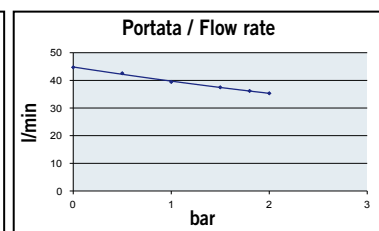
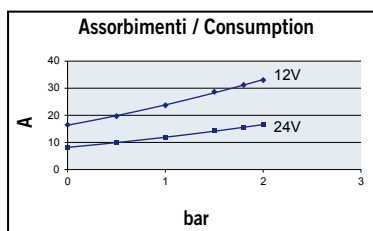
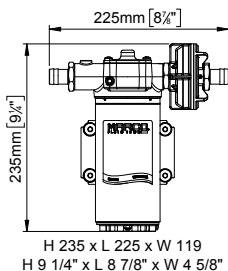

PORTATA
FLOW RATE
max. **46 l/min**
12.2 gpm

PRESSIONE
PRESSURE
max. **2 bar**
29 psi

CODICE PART NUMBER	VOLTS	ADESCAM. SELF-PRIM. m	CONS.	MOTORE MOTOR	FUSIBILE FUSE	TUBO TUBE	BOCCHIE PORTS	PESO WEIGHT
164 502 12	12	3	16A	400W	30A	19 mm	3/4" BSPP	5 kg
164 502 13	24	3	8A	400W	20A	19 mm	3/4" BSPP	5 kg

UP14-PV

▪ Integrated check valve



12V
24V

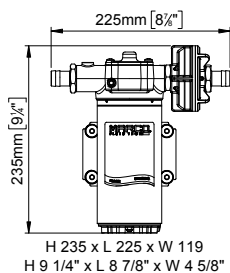

H 235 x L 225 x W 119
H 9 1/4" x L 8 7/8" x W 4 5/8"

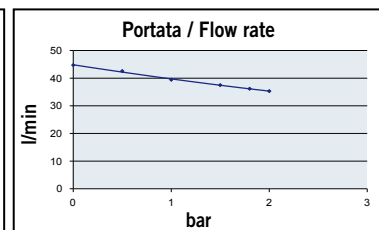
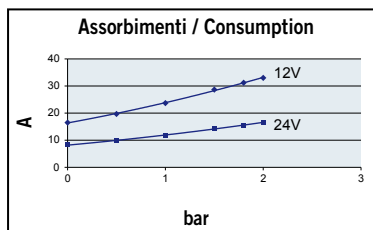

PORTATA FLOW RATE max.	PRESSIONE PRESSURE max.
46 l/min 12.2 gpm	2 bar 29 psi

CODICE PART NUMBER	VOLTS	ADESCAM. SELF-PRIM. m	CONS.	MOTORE MOTOR	FUSIBILE FUSE	TUBO TUBE	BOCCHIE PORTS	PESO WEIGHT
164 504 12	12	3	16A	400W	30A	19 mm	3/4" BSPP	5 kg
164 504 13	24	3	8A	400W	20A	19 mm	3/4" BSPP	5 kg

UP8-P

▪ Heavy duty ▪ Compact footprint



12V
24V

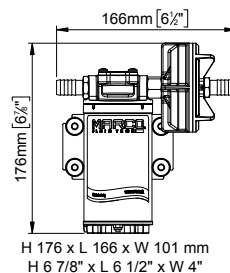

H 176 x L 166 x W 101 mm
H 6 7/8" x L 6 1/2" x W 4"

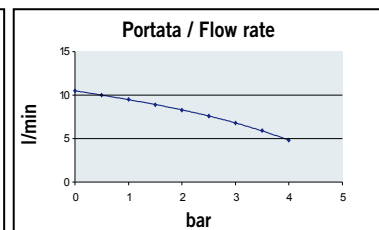
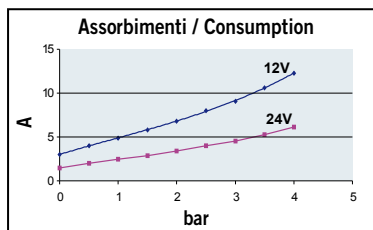

PORTATA FLOW RATE max.	PRESSIONE PRESSURE max.
10 l/min 2.6 gpm	4 bar 58 psi

HIGH PRESSURE

CODICE PART NUMBER	VOLTS	ADESCAM. SELF-PRIM. m	CONS.	MOTORE MOTOR	FUSIBILE FUSE	TUBO TUBE	BOCCHIE PORTS	PESO WEIGHT
164 091 12	12	1,5	4A	150W	10A	13 mm	3/8" BSPP	1,8 kg
164 091 13	24	1,5	2A	150W	5A	13 mm	3/8" BSPP	1,8 kg

UP9-P



12V
24V

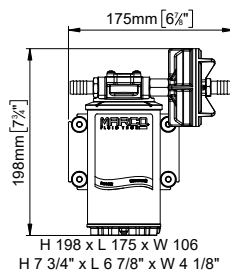

H 198 x L 175 x W 106
H 7 3/4" x L 6 7/8" x W 4 1/8"

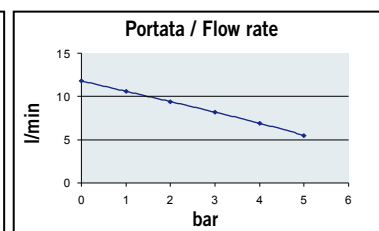
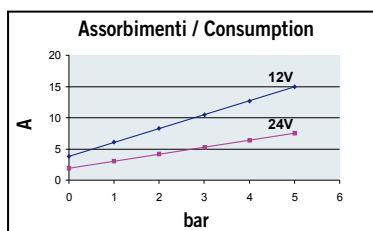

PORTATA FLOW RATE max.	PRESSIONE PRESSURE max.
12 l/min 3.2 gpm	5 bar 72.5 psi

HIGH PRESSURE

CODICE PART NUMBER	VOLTS	ADESCAM. SELF-PRIM. m	CONS.	MOTORE MOTOR	FUSIBILE FUSE	TUBO TUBE	BOCCHIE PORTS	PESO WEIGHT
164 102 12	12	1,5	5A	180W	15A	13 mm	3/8" BSPP	2,7 kg
164 102 13	24	1,5	3A	180W	7,5A	13 mm	3/8" BSPP	2,7 kg

UP10-P



12V

24V

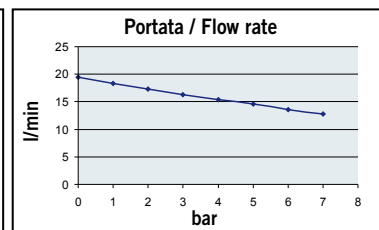
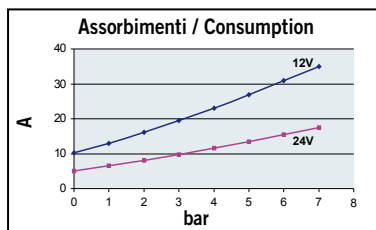
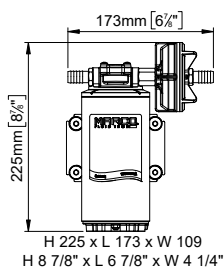

PEEK GEARS

PORTATA
FLOW RATE
max.

18 l/min
4.8 gpm

PRESSIONE
PRESSURE
max.

7 bar
101.5 psi

HIGH PRESSURE

CODICE PART NUMBER	VOLTS	ADESCAM. SELF-PRIM. m	CONS.	MOTORE MOTOR	FUSIBILE FUSE	TUBO TUBE	BOCCHIE PORTS	PESO WEIGHT
164 402 12	12	3	11A	360W	25A	13 mm	3/8" BSPP	3,8 kg
164 402 13	24	3	5A	360W	20A	13 mm	3/8" BSPP	3,8 kg

IMPELLER PUMPS



ISO 8849
ISO 8846

FLEXIBLE IMPELLER



REVERSIBLE



IT Elettropompe autoadescanti con girante flessibile in gomma. La girante in gomma garantisce alta portata e permette il passaggio di piccole impurità contenute nelle acque grigie. Disponibili con portate da 28 l/min a 45 l/min e in versioni con interruttore o deviatore integrati. Dotate di portaspazzole interno con filtro antidisturbo EMI, calotta impermeabile e passacavo stagno. Corpo in ottone nichelato, albero in acciaio inossidabile. Tenute in FKM e O-ring in NBR. ISO 8849 e ISO 8846.

DE Selbstansaugende Elektropumpen mit flexiblem Schaufelrad aus Nitrilgummi. Das Schaufelrad aus Gummi garantiert für eine hohe Leistung und erlaubt das Vorbeifließen von kleinen Unreinheiten, die in Grauwasser vorhanden sind. Jetzt verfügbar mit Förderleistung 28l/min und 45l/min. Erhältlich entweder mit integriertem Ein- und Aus Schalter oder 3-Positionen-Schalter. Wird mit internem Bürstenhalter mit EMI-Filter, wasserdichtem Deckel und Kabeldurchgang geliefert. Gehäuse aus vernickeltem Messing, Spindel aus rostfreiem Stahl. Dichtungen aus FKM und O-Ring aus NBR. ISO 8849 und ISO 8846.

FR Pompes électriques auto-amorçantes avec rotor flexible vulcanisé. Le rotor assure un débit élevé et permet le passage de petites impuretés dans les eaux usées. Disponibles avec capacités de 28 l / min jusqu'à 45 l / min et en versions avec interrupteur ou déviateur intégrés. Corps en laiton nickelé, arbre en acier inoxydable, joint en FKM et O-Ring en NBR. Le port balais se trouve à l'intérieur, protégé par une calotte avec galoche, joint et filtre EMI. ISO 8849 ET ISO 8846.

EN Self-priming electric pumps with rubber impeller. The rubber impeller guarantees a high flow rate and allows the passage of small impurities in wastewaters. Available with capacities from 28l/min up to 45 l/min and in versions with integrated on-off switch or flow reverser switch. Nickel-plated brass body and stainless steel shaft, FKM seals and NBR O-rings. Fitted with waterproof cable guide and internal brush holder with EMI filter. ISO 8846 and ISO 8849.

ES Electrobombas auto-cebadas con impulsor vulcanizado. El impulsor asegura un caudal elevado y permite el paso de pequeñas impurezas en el agua residual. Disponibles con capacidades desde 28 l/min hasta a 45 l/min y en versiones con interruptor o desviador de flujo integrados. Cuerpo en latón niquelado, eje en acero inoxidable. Sellos en FKM y O-ring and NBR. Equipadas con pasa-cable impermeable y porta-escobillas interno con filtro EMI. ISO 8846 e ISO 8849.

PT Eletrobombas autoaspirantes com impulsor de borracha. O impulsor garante um fluxo elevado e a passagem de pequenas impurezas contidas na água de resíduos. Agora disponíveis em 3 dimensões com capacidades de 28 l/min até 45 l/min e em versões com interruptor on-off ou desviador de fluxo integrados. Corpo em latão niquelado, eixo em aço inox. Selos em FKM y O-ring em NBR. Porta-escovas interno com filtro EMI, tampa impermeável e passa fios hermético. ISO 8849 e ISO 8846.

IMPELLER PUMPS 12V and 24V - DC

UP1-J



12V
24V

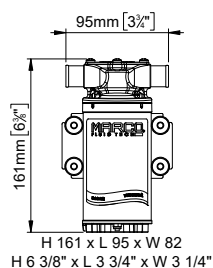

H 161 x L 95 x W 82
H 6 3/8" x L 3 3/4" x W 3 1/4"

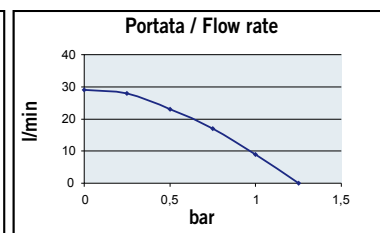
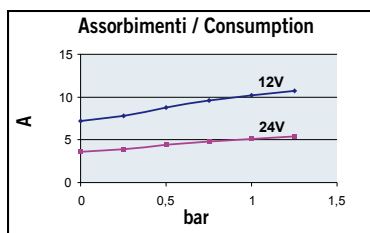

PORTATA
FLOW RATE
max.

28 l/min
7.4 gpm

PRESSIONE
PRESSURE
max.

1 bar
14.5 psi

CODICE
PART NUMBER

VOLTS

ADESCAM.
SELF-PRIM.
m

CONS.

MOTORE
MOTOR

FUSIBILE
FUZE

TUBO
TUBE

BOCCHIE
PORTS

PESO
WEIGHT

162 004 12

12

1,5

8A

150W

10A

20 mm

3/8" BSPP

1,8 kg

162 004 13

24

1,5

4A

150W

7,5A

20 mm

3/8" BSPP

1,8 kg

UP1-JS

On/Off switch



12V
24V

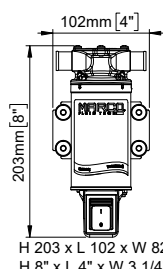

H 203 x L 102 x W 82
H 8" x L 4" x W 3 1/4"

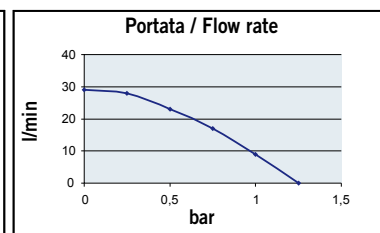
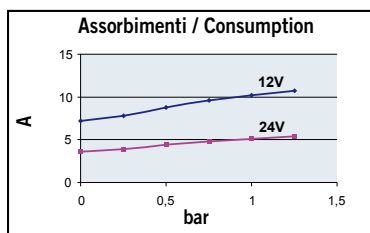

PORTATA
FLOW RATE
max.

28 l/min
7.4 gpm

PRESSIONE
PRESSURE
max.

1 bar
14.5 psi

CODICE
PART NUMBER

VOLTS

ADESCAM.
SELF-PRIM.
m

CONS.

MOTORE
MOTOR

FUSIBILE
FUZE

TUBO
TUBE

BOCCHIE
PORTS

PESO
WEIGHT

162 010 12

12

1,5

8A

150W

10A

20 mm

3/8" BSPP

1,8 kg

162 010 13

24

1,5

4A

150W

7,5A

20 mm

3/8" BSPP

1,8 kg

UP1-JR

On/Off 3 positions
reversing switch



12V
24V

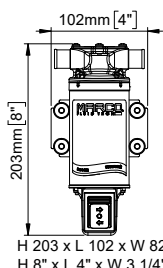

H 203 x L 102 x W 82
H 8" x L 4" x W 3 1/4"

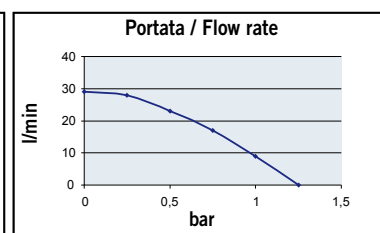
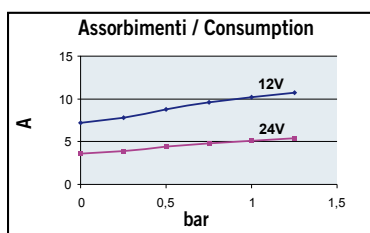

PORTATA
FLOW RATE
max.

28 l/min
7.4 gpm

PRESSIONE
PRESSURE
max.

1 bar
14.5 psi

CODICE
PART NUMBER

VOLTS

ADESCAM.
SELF-PRIM.
m

CONS.

MOTORE
MOTOR

FUSIBILE
FUZE

TUBO
TUBE

BOCCHIE
PORTS

PESO
WEIGHT

162 011 12

12

1,5

8A

150W

10A

20 mm

3/8" BSPP

1,8 kg

162 011 13

24

1,5

4A

150W

7,5A

20 mm

3/8" BSPP

1,8 kg

UP1



12V
24V

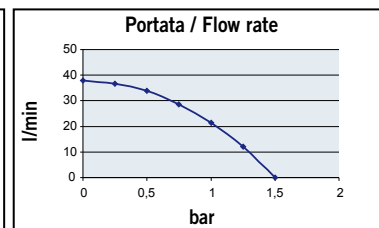
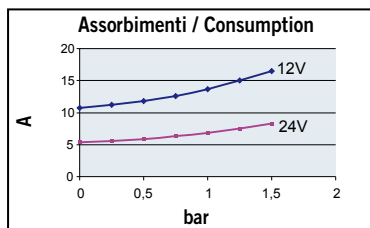
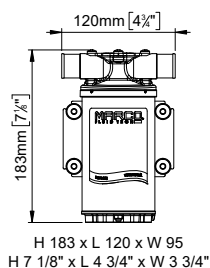

PORTATA FLOW RATE max.	PRESSIONE PRESSURE max.
35 l/min <i>9.2 gpm</i>	1,2 bar <i>17.4 psi</i>

CODICE PART NUMBER	VOLTS	ADESCAM. SELF-PRIM. m	CONS.	MOTORE MOTOR	FUSIBILE FUSE	TUBO TUBE	BOCCHIE PORTS	PESO WEIGHT
162 002 12	12	1,5	10A	180W	20A	25 mm	1/2" BSPP	2,9 kg
162 002 13	24	1,5	5A	180W	15A	25 mm	1/2" BSPP	2,9 kg

UP1-M



12V
24V

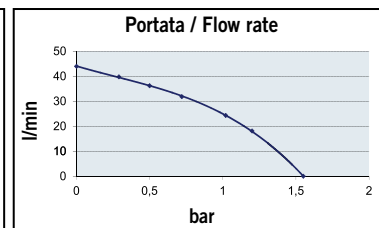
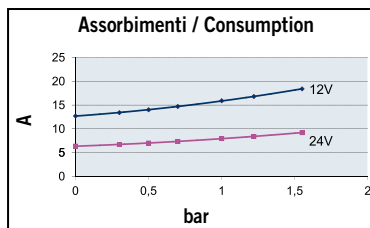
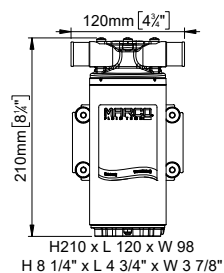

PORTATA FLOW RATE max.	PRESSIONE PRESSURE max.
45 l/min <i>11.9 gpm</i>	1,5 bar <i>21.8 psi</i>

CODICE PART NUMBER	VOLTS	ADESCAM. SELF-PRIM. m	CONS.	MOTORE MOTOR	FUSIBILE FUSE	TUBO TUBE	BOCCHIE PORTS	PESO WEIGHT
162 006 12	12	1,5	14A	360W	20A	25 mm	1/2" BSPP	4,1 kg
162 006 13	24	1,5	7A	360W	15A	25 mm	1/2" BSPP	4,1 kg

UP1-B



OPTIONAL

RCS Control Panel (page 75)

- Reversible
- Ideal for ballast applications



12V
24V

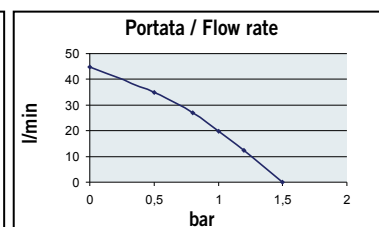
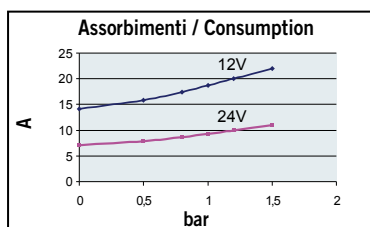
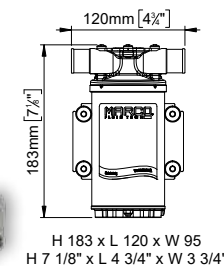

PORTATA FLOW RATE max.	PRESSIONE PRESSURE max.
45 l/min <i>11.9 gpm</i>	1,5 bar <i>21.8 psi</i>

CODICE PART NUMBER	VOLTS	ADESCAM. SELF-PRIM. m	CONS.	MOTORE MOTOR	FUSIBILE FUSE	TUBO TUBE	BOCCHIE PORTS	PESO WEIGHT
162 003 12	12	1,5	14A	180W	20A	25 mm	1/2" BSPP	2,9 kg
162 003 13	24	1,5	7A	180W	15A	25 mm	1/2" BSPP	2,9 kg

IMPELLER PUMPS 110V and 230V - AC

UP1/AC

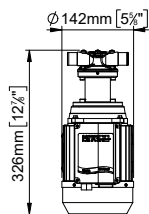

H 326 x L 142 x W 195
H 12 7/8" x L 5 5/8" x W 7 5/8"

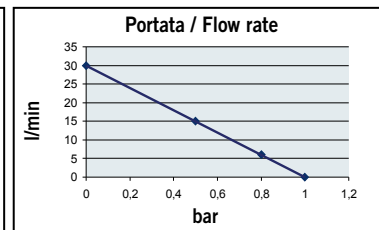
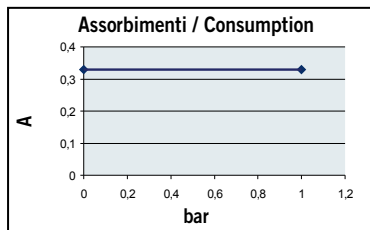

230V
110V

	PORTATA FLOW RATE max.	PRESSIONE PRESSURE max.	CODICE PART NUMBER	VOLTS	ADESCAM. SELF-PRIM. m	CONS.	MOTORE MOTOR	FUSIBILE FUZE	TUBO TUBE	BOCCHIE PORTS	PESO WEIGHT
230V	30 l/min 7.9 gpm	1 bar 14.5 psi	162 001 1C	230	1,5	3,3A	550W	4A	25 mm	1/2" BSPP	7,3 kg
110V	36 l/min 9.5 gpm	1 bar 14.5 psi	162 001 1B	110	1,5	7A	550W	8A	25 mm	1/2" BSPP	7,3 kg

110V VERSION: M.O.Q. 20 PCS

Spare parts and accessories



Page 76

SUBMERSIBLE PUMPS 12V and 24V - DC



IT Elettropompe ad immersione per svuotamento ad alta portata e bassa prevalenza. Involucro in robusto ABS antiurto, resistente alla corrosione ed alla elettrolisi.

DE Elektrische Tauchpumpe für Entleerung mit hoher Förderleistung und niedriger Förderhöhe. Das Gehäuse ist aus robustem Antistoß-ABS, beständig gegen Korrosion und Elektrolyse.

FR Pompes immergées pour opérations de vidange. Haut débit et basse pression. Corps de robuste ABS antichoc, résistant à la corrosion et à l'électrolyse.

EN Submersible pumps, especially fit for emptying operations. High flow and low head. Compact design with ABS housing, corrosion and electrolysis resistant.

ES Electrobombas sumergibles para operaciones de vaciamiento. Alta capacidad y baja prevalencia. Cuerpo en robusto ABS resistente a la corrosión y a la electrólisis.

PT Bombas submersíveis para operações de esvaziamento. Alta capacidade e baixa pressão. Carcaça em ABS reforçado, resistente à corrosão e eletrólise.

UP500

▪ ISO 8849 ▪ ISO 8846



12V
24V

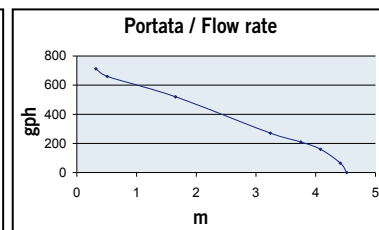
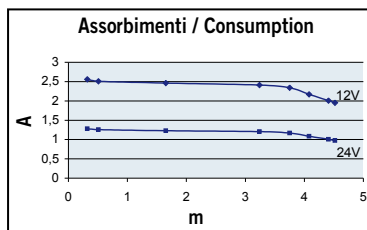
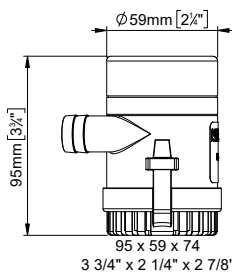

PORTATA
FLOW RATE
max.

32 l/min
500 gph

PRESSIONE
PRESSURE
max.

0,4 bar
5.8 psi

CODICE PART NUMBER	VOLTS	PREVALENZA LIFT	CONS.	MOTORE MOTOR	FUSIBILE FUZE	TUBO TUBE	PESO WEIGHT
160 100 12	12	4 m	2,5A	30W	5A	19 mm	0,5 kg
160 100 13	24	4 m	1,2A	30W	3A	19 mm	0,5 kg

UP1000

▪ ISO 8849 ▪ ISO 8846



12V
24V

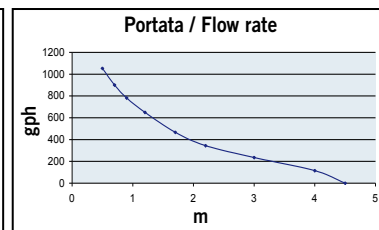
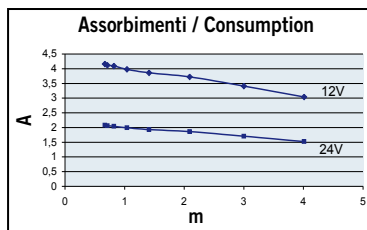
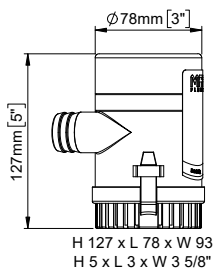

PORTATA
FLOW RATE
max.

63 l/min
1000 gph

PRESSIONE
PRESSURE
max.

0,4 bar
5.8 psi

CODICE PART NUMBER	VOLTS	PREVALENZA LIFT	CONS.	MOTORE MOTOR	FUSIBILE FUZE	TUBO TUBE	PESO WEIGHT
160 120 12	12	4 m	4A	50W	10A	30 mm	1 kg
160 120 13	24	4 m	2A	50W	5A	30 mm	1 kg

UP1500

▪ Heavy duty ▪ ISO 8849 ▪ ISO 8846



12V
24V

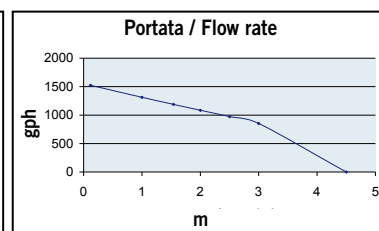
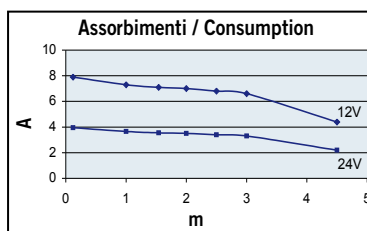
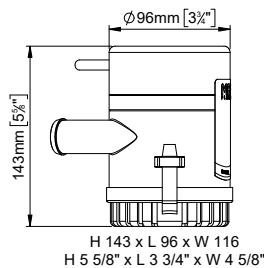

PORTATA
FLOW RATE
max.

95 l/min
1500 gpm

PRESSIONE
PRESSURE
max.

0,4 bar
5.8 psi

CODICE PART NUMBER	VOLTS	PREVALENZA LIFT	CONS.	MOTORE MOTOR	FUSIBILE FUZE	TUBO TUBE	PESO WEIGHT
160 140 12	12	4 m	10A	120W	20A	30 mm	1,5 kg
160 140 13	24	4 m	5A	120W	10A	30 mm	1,5 kg

UP2000

▪ Heavy duty ▪ ISO 8849 ▪ ISO 8846



12V
24V

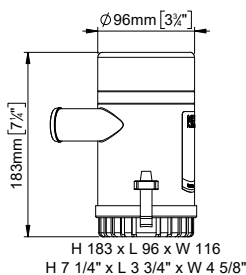

H 183 x L 96 x W 116
H 7 1/4" x L 3 3/4" x W 4 5/8"

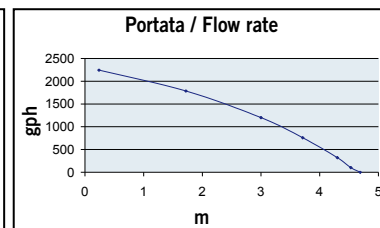
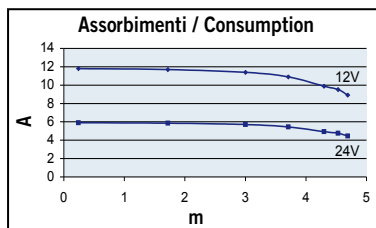

PORTATA
FLOW RATE
max.

PRESSIONE
PRESSURE
max.

126 l/min
2000 gph

0,4 bar
5.8 psi

CODICE PART NUMBER	VOLTS	PREVALENZA LIFT	CONS.	MOTORE MOTOR	FUSIBILE FUZE	TUBO TUBE	PESO WEIGHT
160 160 12	12	4 m	12A	150W	25A	32 mm	2 kg
160 160 13	24	4 m	6A	150W	15A	32 mm	2 kg

UP3700

▪ Heavy duty ▪ ISO 8849 ▪ ISO 8846



24V

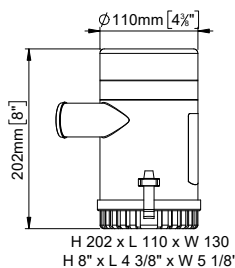

H 202 x L 110 x W 130
H 8" x L 4 3/8" x W 5 1/8"

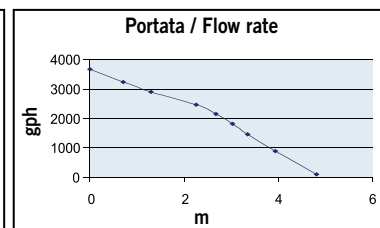
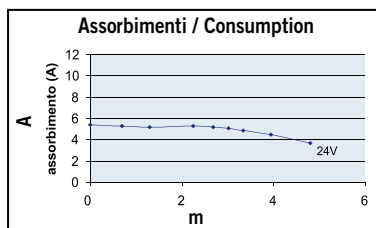

PORTATA
FLOW RATE
max.

PRESSIONE
PRESSURE
max.

233 l/min
3700 gph

0,5 bar
7.3 psi

CODICE PART NUMBER	VOLTS	PREVALENZA LIFT	CONS.	MOTORE MOTOR	FUSIBILE FUZE	TUBO TUBE	PESO WEIGHT
160 180 13	24	5 m	6A	200W	10A	38 mm	3,2 kg

Spare parts and accessories

AS3



BRONZE GEAR PUMPS

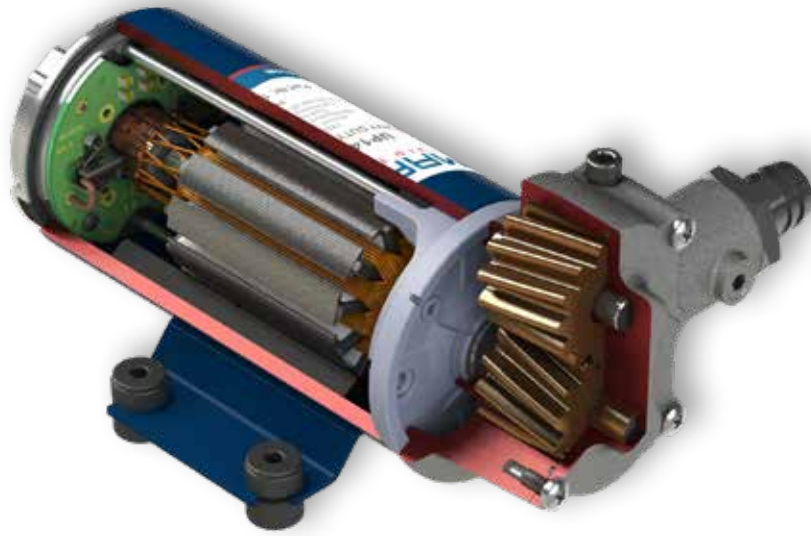

BRONZE GEARS

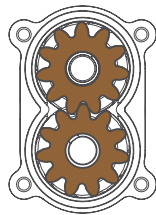

REVERSIBLE



IT Elettropompe autoadescanti di dimensioni compatte con ingranaggi in bronzo per travaso diesel. Gli ingranaggi elicoidali in bronzo garantiscono pressione costante, cicli di lavoro prolungati, maggiore silenziosità e possono operare anche in mancanza di liquido. Corpo in ottone nichelato, albero in acciaio inossidabile. Tenute in FKM e O-ring in NBR. Disponibili in versioni dotate di: carter con maniglia, interruttore o deviatore integrati e controllo elettronico.

DE Kompakte, selbstansaugende Elektropumpe mit Bronzeshnradern zum Umfüllen von Diesel. Die Bronze- Schräg Zahnräder garantieren einen konstanten Druck, verlängerte Arbeitszyklen, sind geräuschärmer und können auch ohne Flüssigkeit arbeiten. Gehäuse aus vernickeltem Messing, Spindel aus rostfreiem Stahl. Dichtungen aus FKM und O-Ring aus NBR. Erhältlich in den Modellen mit Tragetasche, integriertem Schalter oder Wechselschalter und elektronischer Kontrolle.

FR Pompes électriques auto-amorçantes de dimensions réduites avec engrenages en bronze pour transvasement de diesel. Les engrenages hélicoïdaux en bronze assurent une pression constante, des cycles de travail longs, moins de bruit et peuvent également fonctionner en l'absence de liquide. Corps de laiton nickelé, arbre en acier inoxydable, joint en FKM et O-Ring en NBR. Disponibles en versions avec boîtier muni de poignée, avec interrupteur ou déviateur intégrés et avec contrôle électronique.

EN Self-priming electric pumps of compact footprint with bronze gears for diesel transfer. Helical bronze gears guarantee constant pressure, heavy duty cycles, less noise and can operate in the absence of liquid. Body in nickel-plated brass and shaft in stainless steel. FKM seals and NBR O-rings. Available in versions with portable case, integrated on-off switch or flow reverser switch and electronic control.

ES Electrobombas auto cebadas de pequeñas dimensiones con engranajes en bronce para transvase de diésel. Los engranajes helicoidales de bronce garantizan presión constante, largos ciclos de trabajo, menos ruido y pueden operar en ausencia de líquido. Cuerpo en latón niquelado, eje en acero inoxidable. Sellos de FKM y O-ring de NBR. Disponibles en versiones con Kit portable, interruptor o desviador de flujo integrados y control electrónico.

PT Eletrobombas autoaspirantes de pequenas dimensões com engrenagens em bronze para trasfega de diesel. As engrenagens helicoidais de bronze garantem uma pressão constante, longos ciclos de trabalho, menos ruído e também podem funcionar sem líquido. Corpo em latão niquelado, eixo em aço inox. Selos de FKM e O-ring de NBR. Disponíveis em versões com kit portátil, interruptor on-off ou desviador de fluxo integrados e controle eletrônico.

BRONZE GEARS

12V and 24V - DC

UP2



12V
24V

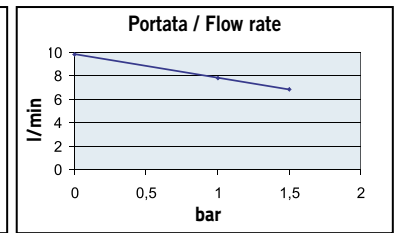
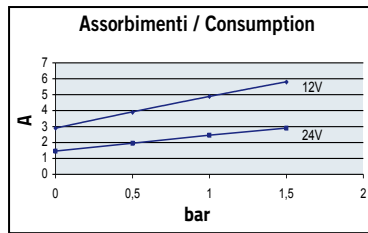
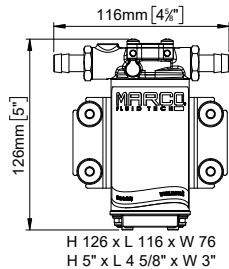

PORTATA FLOW RATE max.	PRESSIONE PRESSURE max.
10 l/min 2.6 gpm	1,5 bar 22 psi

CODICE PART NUMBER	VOLTS	ADESCAM. SELF-PRIM. m	CONS.	MOTORE MOTOR	FUSIBILE FUZE	TUBO TUBE	BOCCHIE PORTS	PESO WEIGHT
164 200 12	12	1,5	3A	90W	5A	12 mm	3/8" BSPP	1,2 kg
164 200 13	24	1,5	1,5A	90W	3A	12 mm	3/8" BSPP	1,2 kg

UP3



12V
24V

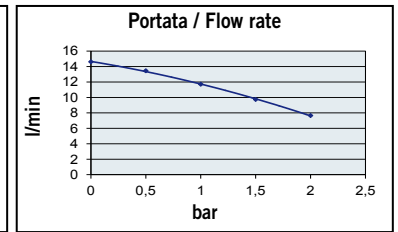
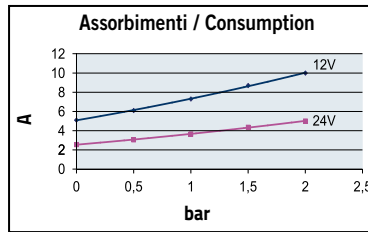
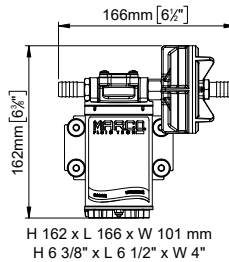

PORTATA FLOW RATE max.	PRESSIONE PRESSURE max.
15 l/min 4 gpm	2 bar 29 psi

CODICE PART NUMBER	VOLTS	ADESCAM. SELF-PRIM. m	CONS.	MOTORE MOTOR	FUSIBILE FUZE	TUBO TUBE	BOCCHIE PORTS	PESO WEIGHT
164 000 12	12	1,5	6A	120W	10A	13 mm	3/8" BSPP	1,4 kg
164 000 13	24	1,5	3A	120W	5A	13 mm	3/8" BSPP	1,4 kg

UP3-CK

▪ Portable kit

I
0 On/Off switch



12V
24V

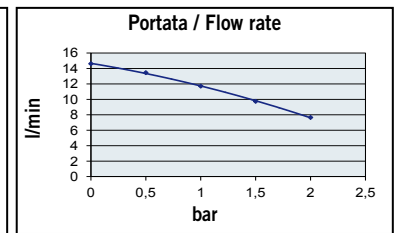
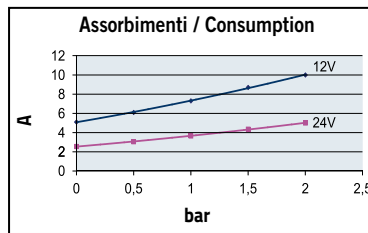
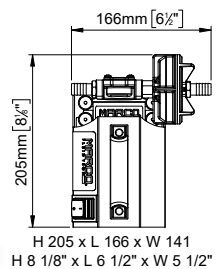

PORTATA FLOW RATE max.	PRESSIONE PRESSURE max.
15 l/min 4 gpm	2 bar 29 psi

CODICE PART NUMBER	VOLTS	ADESCAM. SELF-PRIM. m	CONS.	MOTORE MOTOR	FUSIBILE FUZE	TUBO TUBE	BOCCHIE PORTS	PESO WEIGHT
164 006 12	12	1,5	6A	120W	10A	13 mm	3/8" BSPP	2,8 kg
164 006 13	24	1,5	3A	120W	5A	13 mm	3/8" BSPP	2,8 kg

UP3-S

I On/Off switch
0



12V
24V

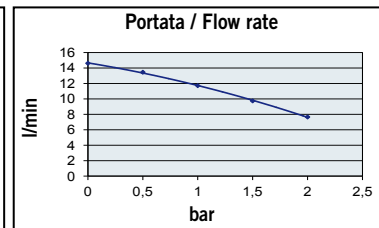
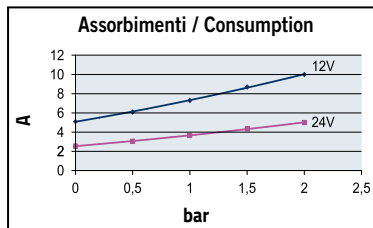
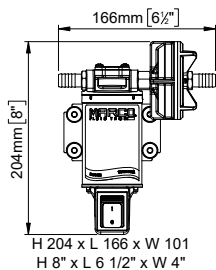

PORTATA
FLOW RATE
max.

15 l/min
4 gpm

PRESSIONE
PRESSURE
max.

2 bar
29 psi

CODICE PART NUMBER	VOLTS	ADESCAM. SELF-PRIM. m	CONS.	MOTORE MOTOR	FUSIBILE FUSE	TUBO TUBE	BOCCHE PORTS	PESO WEIGHT
164 007 12	12	1,5	6A	120W	10A	13 mm	3/8" BSPP	1,8 kg
164 007 13	24	1,5	3A	120W	5A	13 mm	3/8" BSPP	1,8 kg

UP3-R

↕↔↕ On/Off 3 positions
reversing switch



12V
24V

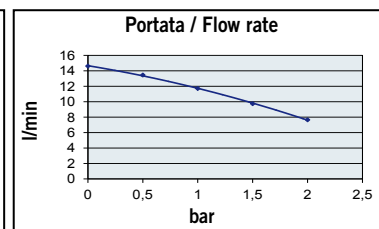
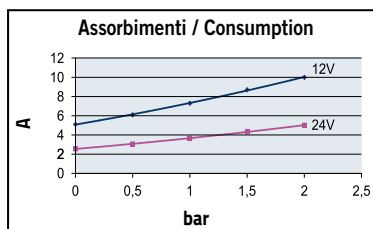
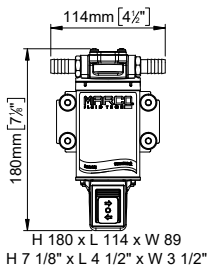

PORTATA
FLOW RATE
max.

15 l/min
4 gpm

PRESSIONE
PRESSURE
max.

2 bar
29 psi

CODICE PART NUMBER	VOLTS	ADESCAM. SELF-PRIM. m	CONS.	MOTORE MOTOR	FUSIBILE FUSE	TUBO TUBE	BOCCHE PORTS	PESO WEIGHT
164 008 12	12	1,5	6A	120W	10A	13 mm	3/8" BSPP	1,8 kg
164 008 13	24	1,5	3A	120W	5A	13 mm	3/8" BSPP	1,8 kg

UP6



12V
24V

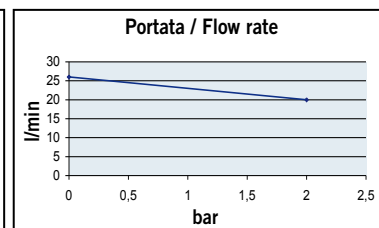
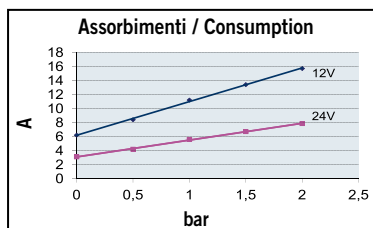
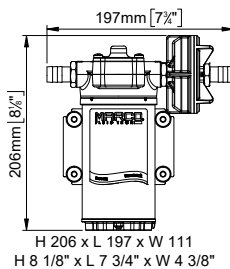

PORTATA
FLOW RATE
max.

26 l/min
6.9 gpm

PRESSIONE
PRESSURE
max.

2 bar
29 psi

CODICE PART NUMBER	VOLTS	ADESCAM. SELF-PRIM. m	CONS.	MOTORE MOTOR	FUSIBILE FUSE	TUBO TUBE	BOCCHE PORTS	PESO WEIGHT
164 060 12	12	2	10A	180W	15A	16 mm	1/2" BSPP	3,2 kg
164 060 13	24	2	5A	180W	7,5A	16 mm	1/2" BSPP	3,2 kg

UP12



12V
24V

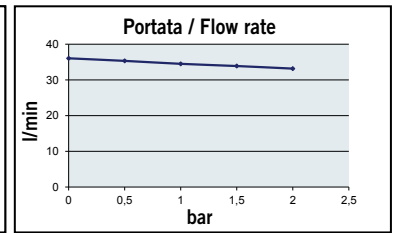
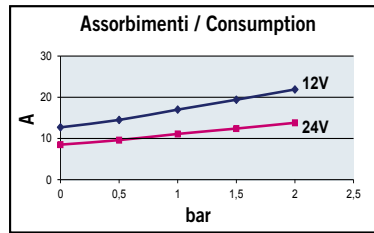
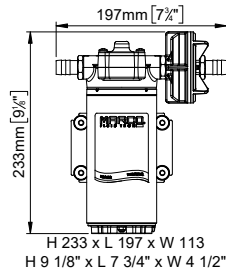

PORTATA
FLOW RATE
max.
36 l/min
9.5 gpm

PRESSIONE
PRESSURE
max.
2 bar
29 psi

CODICE PART NUMBER	VOLTS	ADESCAM. SELF-PRIM. m	CONS.	MOTORE MOTOR	FUSIBILE FUSE	TUBO TUBE	BOCCHIE PORTS	PESO WEIGHT
164 300 12	12	4	14A	360W	20A	16 mm	1/2" BSPP	4,5 kg
164 300 13	24	4	8A	360W	15A	16 mm	1/2" BSPP	4,5 kg

UP14

▪ High flow rate



12V
24V

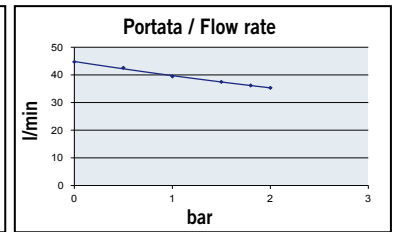
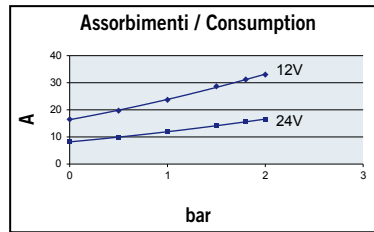
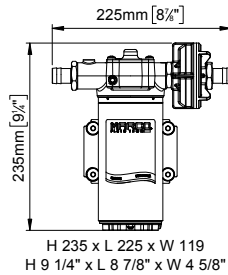

PORTATA
FLOW RATE
max.
46 l/min
12.2 gpm

PRESSIONE
PRESSURE
max.
2 bar
29 psi

CODICE PART NUMBER	VOLTS	ADESCAM. SELF-PRIM. m	CONS.	MOTORE MOTOR	FUSIBILE FUSE	TUBO TUBE	BOCCHIE PORTS	PESO WEIGHT
164 500 12	12	4	16A	400W	30A	19 mm	3/4" BSPP	5,3 kg
164 500 13	24	4	8A	400W	20A	19 mm	3/4" BSPP	5,3 kg

UP8

▪ Heavy duty ▪ Compact footprint



12V
24V

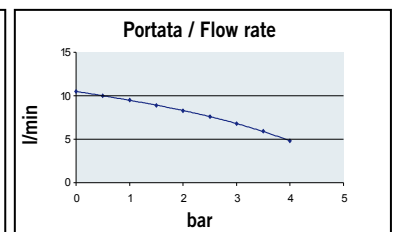
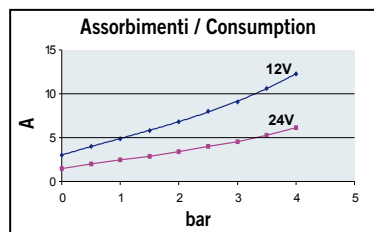
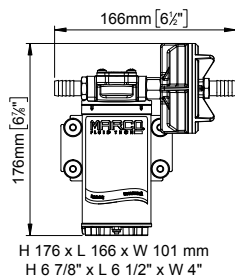

PORTATA
FLOW RATE
max.
10 l/min
2.6 gpm

PRESSIONE
PRESSURE
max.
4 bar
58 psi

CODICE PART NUMBER	VOLTS	ADESCAM. SELF-PRIM. m	CONS.	MOTORE MOTOR	FUSIBILE FUSE	TUBO TUBE	BOCCHIE PORTS	PESO WEIGHT
164 090 12	12	1,5	4A	150W	10A	13 mm	3/8" BSPP	1,8 kg
164 090 13	24	1,5	2A	150W	5A	13 mm	3/8" BSPP	1,8 kg

HIGH PRESSURE

UP9



12V
24V

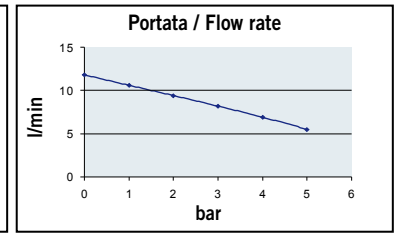
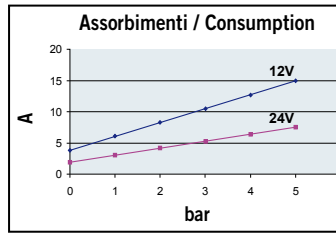
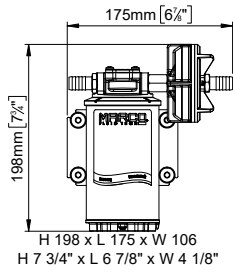

PORTATA
FLOW RATE
max.

PRESSIONE
PRESSURE
max.

12 l/min
3.2 gpm

5 bar
72.5 psi

HIGH PRESSURE

CODICE PART NUMBER	VOLTS	ADESCAM. SELF-PRIM. m	CONS.	MOTORE MOTOR	FUSIBILE FUSE	TUBO TUBE	BOCCHIE PORTS	PESO WEIGHT
164 100 12	12	1,5	5A	180W	15A	13 mm	3/8" BSPP	2,7 kg
164 100 13	24	1,5	3A	180W	7,5A	13 mm	3/8" BSPP	2,7 kg

UP10



12V
24V

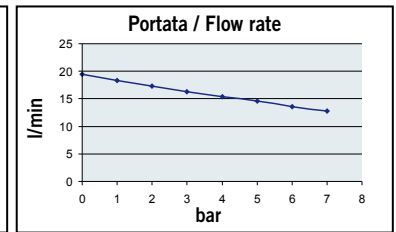
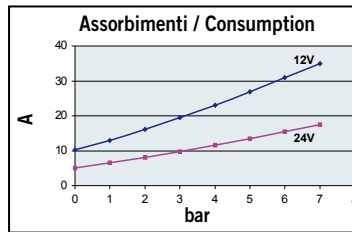
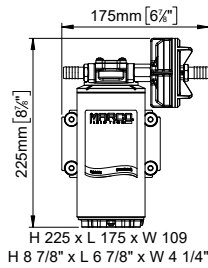

PORTATA
FLOW RATE
max.

PRESSIONE
PRESSURE
max.

18 l/min
4.8 gpm

7 bar
101.5 psi

HIGH PRESSURE

CODICE PART NUMBER	VOLTS	ADESCAM. SELF-PRIM. m	CONS.	MOTORE MOTOR	FUSIBILE FUSE	TUBO TUBE	BOCCHIE PORTS	PESO WEIGHT
164 400 12	12	3	11A	360W	25A	13 mm	3/8" BSPP	3,8 kg
164 400 13	24	3	5A	360W	20A	13 mm	3/8" BSPP	3,8 kg

BRONZE GEARS

110V and 230V - AC

UP3/AC



230V
110V

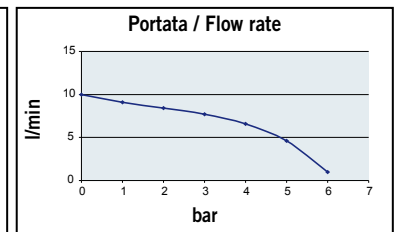
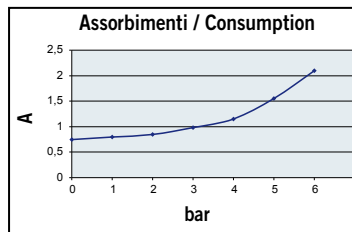
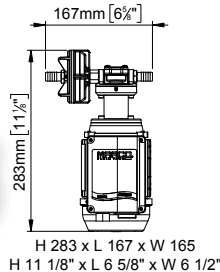

PORTATA
FLOW RATE
max.

PRESSIONE
PRESSURE
max.

10 l/min
2.6 gpm

6 bar
87 psi

12 l/min
3.2 gpm

6 bar
87 psi

CODICE PART NUMBER	VOLT	ADESCAM. SELF-PRIM. m	CONS.	MOTORE MOTOR	FUSIBILE FUSE	TUBO HOSE	BOCCHIE PORTS	PESO WEIGHT
164 001 1C	230	1,5	0,8A	150W	2A	13 mm	3/8" BSPP	4,6 kg
164 001 1B	110	1,5	1,9A	150W	4A	13 mm	3/8" BSPP	4,6 kg

110V VERSION: M.O.Q. 20 PCS

PEEK GEARS

110V and 230V - AC

UP6/AC



230V
110V

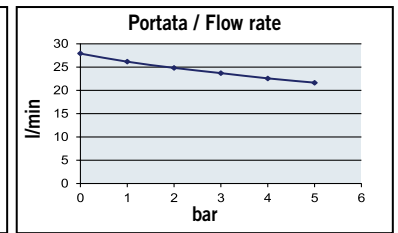
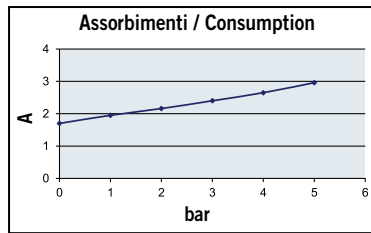
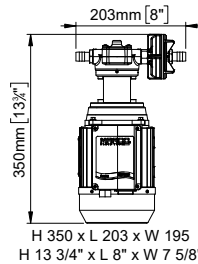

	PORTATA FLOW RATE max.	PRESSIONE PRESSURE max.	CODICE PART NUMBER	VOLT	ADESCAM. SELF-PRIM. m	CONS.	MOTORE MOTOR	FUSIBILE FUZE	TUBO HOSE	BOCCHIE PORTS	PESO WEIGHT
230V	28 l/min 7.4 gpm	5 bar 72.5 psi	164 061 1C	230	1,5	1,7A	550W	3A	16 mm	1/2" BSPP	7,6 kg
110V	34 l/min 9 gpm	5 bar 72.5 psi	164 061 1B	110	1,5	3,8A	550W	5A	16 mm	1/2" BSPP	7,6 kg

110V VERSION: M.O.Q. 20 PCS

UP14/AC

High flow rate



230V
110V

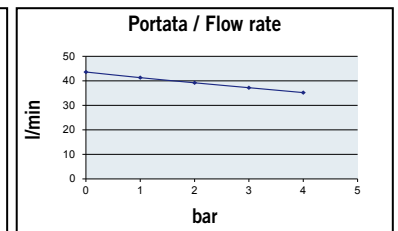
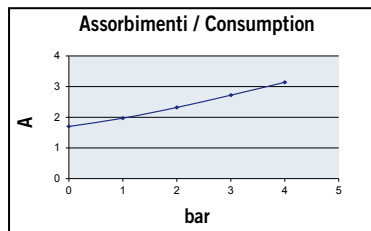
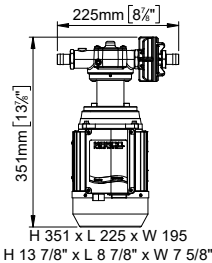

	PORTATA FLOW RATE max.	PRESSIONE PRESSURE max.	CODICE PART NUMBER	VOLT	ADESCAM. SELF-PRIM. m	CONS.	MOTORE MOTOR	FUSIBILE FUZE	TUBO HOSE	BOCCHIE PORTS	PESO WEIGHT
230V	44 l/min 11.6 gpm	4 bar 58 psi	164 540 1C	230	3	1,7A	550W	3A	19 mm	3/4" BSPP	8,1 kg
110V	52,5 l/min 13.9 gpm	4 bar 58 psi	164 540 1B	110	3	3,8A	550W	5A	19 mm	3/4" BSPP	8,1 kg

110V VERSION: M.O.Q. 20 PCS

VANE PUMPS



SLIDING VANES

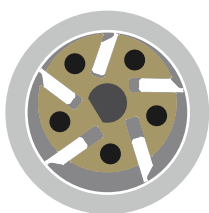

CONNECTION OPTIONS

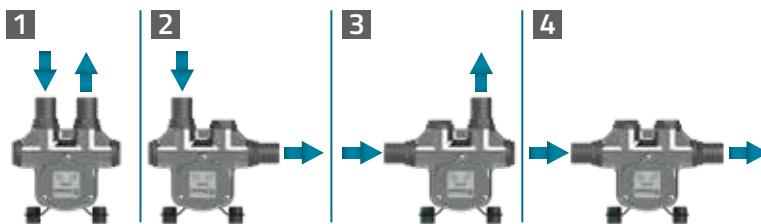

IT Elettropompe autoadescenti a palette, complete di valvola by-pass integrata. Le palette garantiscono alta portata e cicli di lavoro prolungati. Corpo in alluminio con doppia possibilità di connessione per portagomma. Rotore e palette in resina. Albero in acciaio inossidabile. Tenute in FKM e O-ring in NBR. Calotta motore con filtro EMI. Disponibile anche dotata di carter con maniglia per facile trasporto, interruttore on-off e pinze per batteria.

DE Selbstansaugende, Elektro- Schaufelpumpen mit integriertem Bypass-Ventil. Die Schaufeln garantieren für eine erhöhte Leistung und für verlängerte Arbeitszyklen. Aluminiumkörper mit zweifacher Verbindungsmöglichkeit für Schlauchhalter. Rotor und Schaufeln sind aus Harz, Spindel aus rostfreiem Stahl, Dichtungen aus FKM und O-Ring aus NBR. Motordeckel mit EMI-Filter. Auch mit Halterung und Griff für einfachen Transport erhältlich, mit Ein- und Aus- Schalter und Batterieklemmen.

FR Pompes électriques auto-amorçantes à palettes complètes de vanne by-pass intégrée. Les palettes assurent un grand débit et des cycles de travail longs. Corps en aluminium avec double option de connexion pour raccords. Rotor et palettes en résine. Arbre en acier inoxydable, joint en FKM et O-Ring en NBR. Calotte moteur équipée avec filtre EMI. Disponibles aussi avec boîtier muni de poignée pour un transport facile, interrupteur On/Off et pinces pour batterie.

EN Self-priming electric vane pumps with integrated by-pass valve. Vanes guarantee high flow rate and heavy-duty cycles. Aluminum body, two connection options. Rotor and vanes made of resin. Stainless steel shaft. FKM seals and NBR O-rings. Brush holder with EMI filter. Available also with case and handle for easy transport, On/Off switch and battery clips.

ES Electrobombas auto cebadas de paletas con válvula bypass integrada. Las paletas garantizan un caudal grande y largos ciclos de trabajo. Cuerpo en aluminio con doble posibilidad de conexión. Rotor y paletas de resina. Eje en acero inoxidable, sellos de FKM y O-ring de NBR. Tapa del motor con filtro EMI. Disponibles también con cárter y manija para fácil transporte, interruptor On/Off y pinzas para batería.

PT Eletrobombas autoaspirantes de palhetas, completas de válvula by-pass integrada. As palhetas garantem um fluxo muito grande e longos ciclos de trabalho. Corpo em alumínio com dupla possibilidade de ligação. Rotor e palhetas em resina. Eixo em aço inox. Selos de FKM e O-ring de NBR. Calota motor com filtro EMI. Disponíveis também com cárter e empunhadura para fácil transporte, interruptor On/Off e pinças de alimentação.

VANE PUMPS

12V and 24V - DC

VP45-N



12V
24V

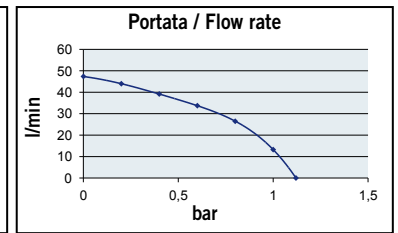
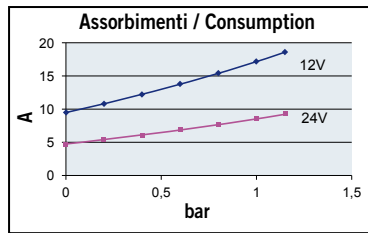
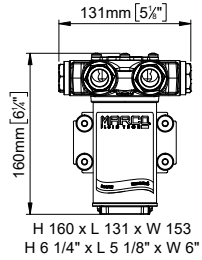

PORTATA FLOW RATE max.	PRESSIONE PRESSURE max.
45 l/min 11.9 gpm	1,2 bar 17.4 psi

CODICE PART NUMBER	VOLTS	ADESCAM. SELF-PRIM. m	CONS.	MOTORE MOTOR	FUSIBILE FUSE	TUBO TUBE	BOCCHIE PORTS	PESO WEIGHT
166 026 12	12	2	8A	150W	20A	25 mm	3/4" BSPP	2 kg
166 026 13	24	2	4A	150W	10A	25 mm	3/4" BSPP	2 kg

VP45

Portable kit



12V
24V

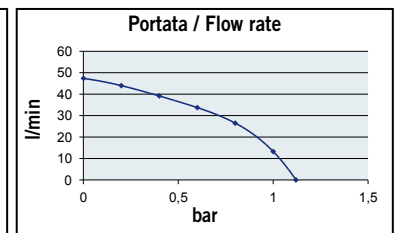
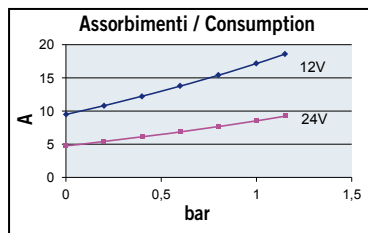
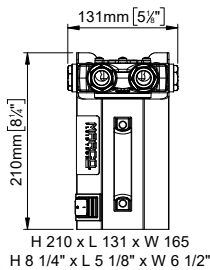

PORTATA FLOW RATE max.	PRESSIONE PRESSURE max.
45 l/min 11.9 gpm	1,2 bar 17.4 psi

CODICE PART NUMBER	VOLTS	ADESCAM. SELF-PRIM. m	CONS.	MOTORE MOTOR	FUSIBILE FUSE	TUBO TUBE	BOCCHIE PORTS	PESO WEIGHT
166 020 12	12	2	8A	150W	20A	25 mm	3/4" BSPP	3,3 kg
166 020 13	24	2	4A	150W	10A	25 mm	3/4" BSPP	3,3 kg

VP45-S

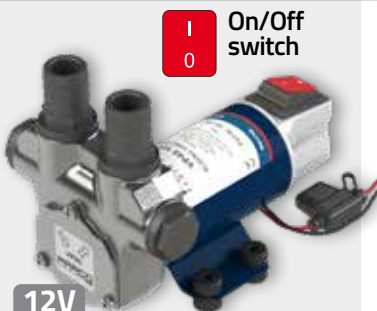

12V
24V

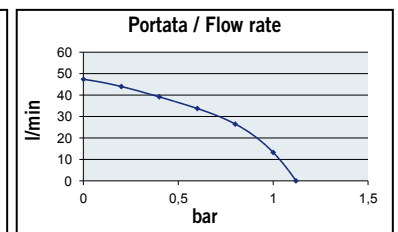
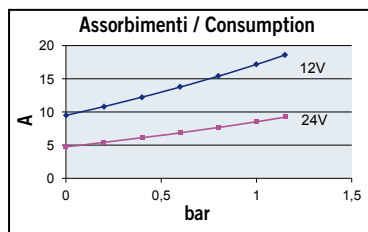
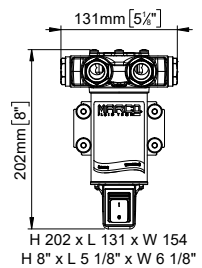

PORTATA FLOW RATE max.	PRESSIONE PRESSURE max.
45 l/min 11.9 gpm	1,2 bar 17.4 psi

CODICE PART NUMBER	VOLTS	ADESCAM. SELF-PRIM. m	CONS.	MOTORE MOTOR	FUSIBILE FUSE	TUBO TUBE	BOCCHIE PORTS	PESO WEIGHT
166 028 12	12	2	8A	150W	20A	25 mm	3/4" BSPP	2,2 kg
166 028 13	24	2	4A	150W	10A	25 mm	3/4" BSPP	2,2 kg

VP45A-S

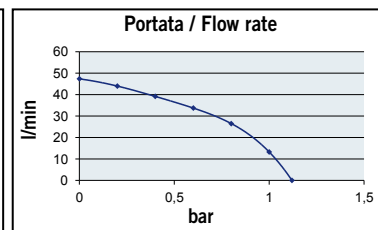
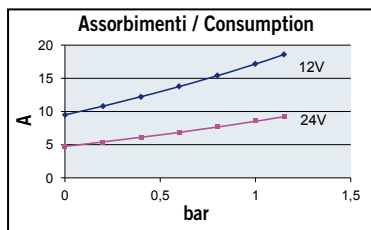
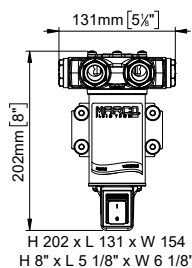

PORTATA FLOW RATE max.	PRESSIONE PRESSURE max.	CODICE PART NUMBER	VOLTS	ADESCAM. SELF-PRIM. m	CONS.	MOTORE MOTOR	FUSIBILE FUSE	TUBO TUBE	BOCCHIE PORTS	PESO WEIGHT
45 l/min 11.9 gpm	1,2 bar 17.4 psi	166 029 12	12	2	8A	150W	20A	20 mm	3/4" BSPP	2,2 kg
		166 029 13	24	2	4A	150W	10A	20 mm	3/4" BSPP	2,2 kg

VP45-K

▪ Complete kit for refueling

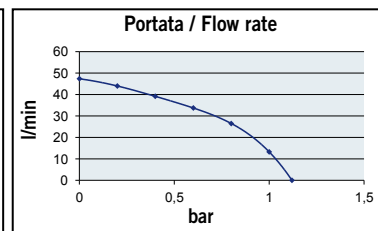
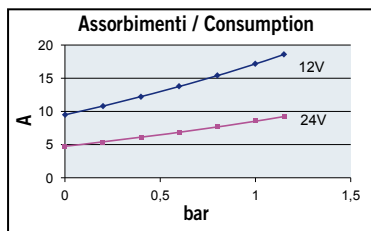
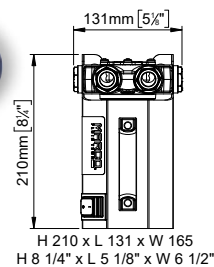

PORTATA FLOW RATE max.	PRESSIONE PRESSURE max.	CODICE PART NUMBER	VOLTS	ADESCAM. SELF-PRIM. m	CONS.	MOTORE MOTOR	FUSIBILE FUSE	TUBO TUBE	BOCCHIE PORTS	PESO WEIGHT
45 l/min 11.9 gpm	1,2 bar 17.4 psi	166 024 12	12	2	8A	150W	20A	25 mm	3/4" BSPP	6,3 kg
		166 024 13	24	2	4A	150W	10A	25 mm	3/4" BSPP	6,3 kg

VANE PUMPS

230V - AC

VP45/AC

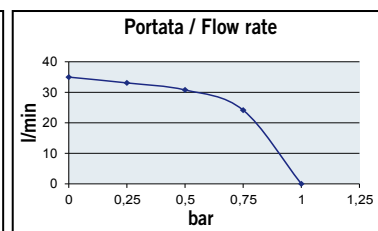
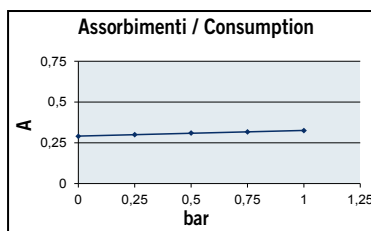
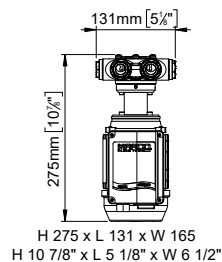

PORTATA FLOW RATE max.	PRESSIONE PRESSURE max.	CODICE PART NUMBER	VOLTS	ADESCAM. SELF-PRIM. m	CONS.	MOTORE MOTOR	FUSIBILE FUSE	TUBO TUBE	BOCCHIE PORTS	PESO WEIGHT
35 l/min 9.2 gpm	1 bar 14.5 psi	166 030 1C	230	1,5	0,8A	150W	1,25A	25 mm	3/4" BSPP	4,7 kg

12/24V ADJUSTABLE SPEED ELECTRONIC PRESSURE PUMPS

SCS Control Panel
see page 65



Electronic Pressure Sensor
see page 37

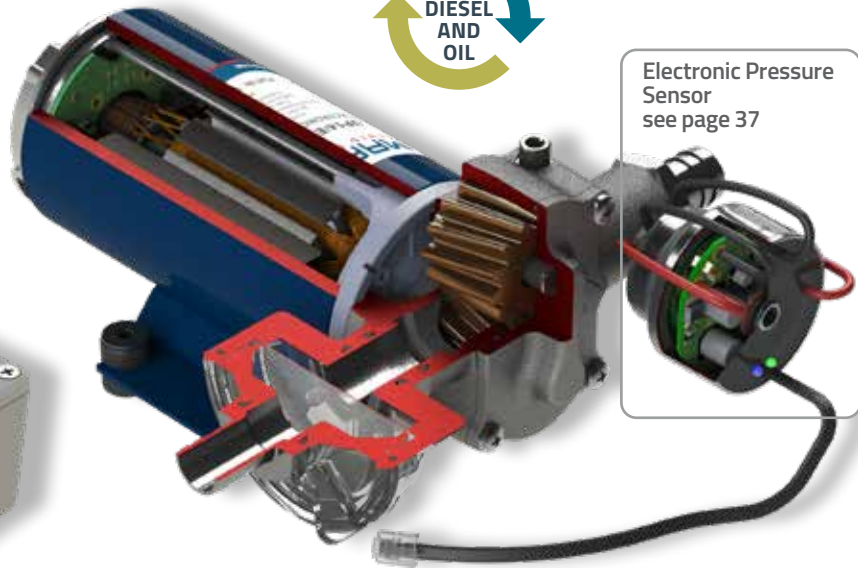

BRONZE GEARS

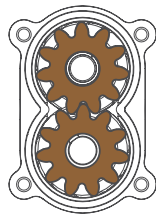

ADJUSTABLE SPEED FOR OILS AND DIESEL

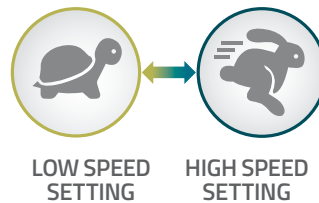

IT Elettropompe automatiche autoadescanti 12/24V con sensore di pressione elettronico per travaso diesel e olio. Ingranaggi in bronzo, valvola di non ritorno in NBR, corpo e connessioni in ottone nichelato, albero in acciaio inossidabile. Tenute in FKM e O-ring in NBR. Gli ingranaggi elicoidali in bronzo garantiscono pressione costante, cicli di lavoro prolungati, maggiore silenziosità e possono operare anche in mancanza di liquido. Impostazione standard dell'elettronica in modalità "High speed" per travaso diesel. Il pannello di controllo SCS integrato consente l'impostazione in modalità "Low Speed" per travaso di olio e liquidi viscosi.

DE Automatische, selbstansaugende Elektropumpen 12/24V mit elektronischem Drucksensor zum Umfüllen von Diesel und Öl. Bronzeshnrad, Rückschlagventil aus NBR, Gehäuse und Verbindungen aus vernickeltem Messing, Spindel aus rostfreiem Stahl. Dichtungen aus FKM und O-Ring aus NBR. Die Bronze- Schräg Zahnräder garantieren für einen konstanten Druck, für längere Arbeitszyklen, für Geräuschreduzierung und können auch ohne Flüssigkeit arbeiten. Elektronische Standardeinstellung im "High Speed"-Modus beim Umfüllen von Diesel. Das integrierte Kontrollpaneel SCS, ermöglicht einen "Low-Speed"-Modus beim Umfüllen von Ölen und anderen zähflüssigen Flüssigkeiten.

FR Pompes électriques automatiques auto-amorçantes 12/24V avec contrôle électronique pour le transfert de diesel et huile. Vanne anti-retour en NBR, corps et raccords en laiton nickelé, arbre en acier inoxydable, joint en FKM et O-Ring en NBR. Les engrenages hélicoïdaux en bronze assurent une pression constante, des cycles de travail longs, moins de bruit et peuvent également fonctionner en l'absence de liquide. La pompe est réglée en mode "High Speed" pour le transfert de diesel. Le panneau de contrôle SCS intégré permet la mise en "Low Speed" pour le transfert de huile et de liquides visqueux.

EN Self-priming automatic electric pumps, 12/24V, with electronic control for the transfer of diesel and oil. Bronze gears, NBR check valve, body and connections in nicked brass, stainless steel shaft. FKM seals and NBR O-rings. Helical bronze gears guarantee constant pressure, heavy duty cycles, less noise and can operate in the absence of liquid. The pumps are supplied with a "High-Speed" setting for Diesel transfer. **The integrated SCS control panel allows the switch to the "Low-Speed" mode for the transfer of oil and viscous liquids.**

ES Electrobombas automáticas auto-cebadas, 12/24V, con control electrónico para transvase de diésel y aceite. Engranajes de bronce, válvula de retención de NBR, cuerpo y conexiones en latón niquelado, eje en acero inoxidable. Sellos de FKM y O-ring de NBR. Los engranajes helicoidales de bronce garantizan presión constante, largos ciclos de trabajo, menos ruido y pueden operar en ausencia de líquido. La electrónica está configurada en modalidad "High Speed" para el transvase de diésel. **El panel de control SCS integrado permite el cambio a la modalidad "Low Speed" para transvase de aceite y líquidos viscosos.**

PT Electrobombas automáticas autoaspirantes, 12/24V, com controle eletrônico para trasfega de diesel e óleos. Engrenagens em bronze, válvula de retenção em NBR, corpo e ligações em latão niquelado, eixo em aço inox. Selos de FKM e O-ring de NBR. As engrenagens helicoidais de bronze garantem uma pressão constante, longos ciclos de trabalho, menos ruído e também podem funcionar sem líquido. As bombas são fornecidas na modalidade "High Speed" para trasfega do diesel. **O painel de controle SCS integrado permite a mudança para a modalidade "Low Speed" para a trasfega de óleos e líquidos viscosos.**

12/24V ADJUSTABLE SPEED ELECTRONIC PRESSURE PUMPS

UP2/E-BR

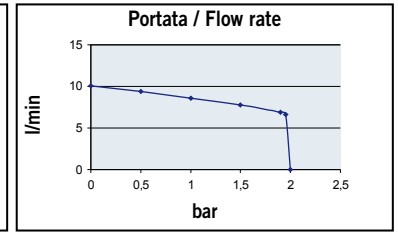
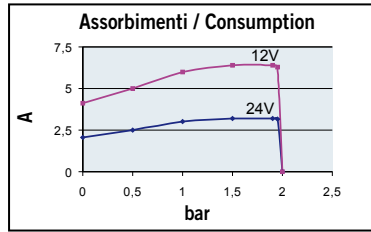
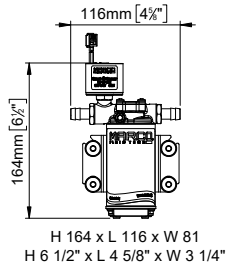

12/24V

PORTATA FLOW RATE max.	PRESSIONE PRESSURE max.	CODICE PART NUMBER	VOLTS	ADESCAM. SELF-PRIM. m	CONS.	MOTORE MOTOR	FUSIBILE FUZE	TUBO TUBE	BOCCHIE PORTS	PESO WEIGHT
10 l/min 2.6 gpm	2 bar 29 psi	164 700 15	12/24	1,5	3A / 1,5A	90W	7,5A	12 mm	3/8" BSPP	1,3 kg

UP3/E-BR

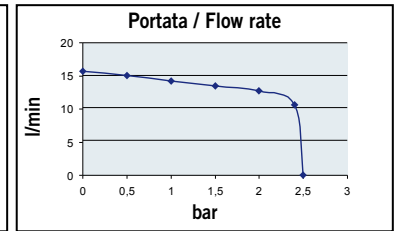
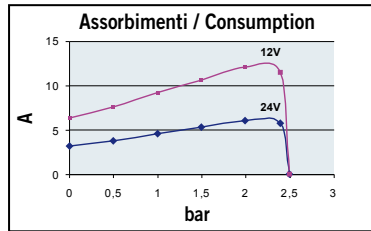
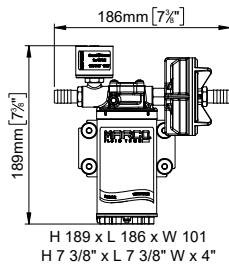

12/24V

PORTATA FLOW RATE max.	PRESSIONE PRESSURE max.	CODICE PART NUMBER	VOLTS	ADESCAM. SELF-PRIM. m	CONS.	MOTORE MOTOR	FUSIBILE FUZE	TUBO TUBE	BOCCHIE PORTS	PESO WEIGHT
15 l/min 4 gpm	2,5 bar 36 psi	164 710 15	12/24	1,5	6A / 3A	150W	15A	13 mm	3/8" BSPP	2 kg

UP6/E-BR

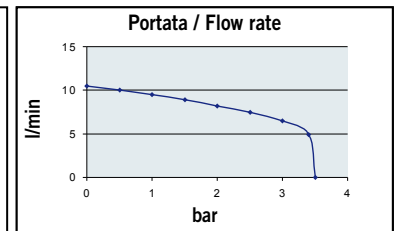
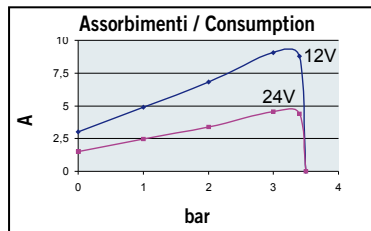
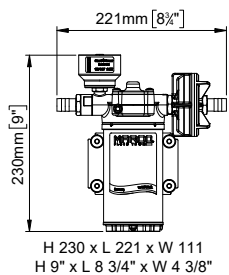

12/24V

PORTATA FLOW RATE max.	PRESSIONE PRESSURE max.	CODICE PART NUMBER	VOLTS	ADESCAM. SELF-PRIM. m	CONS.	MOTORE MOTOR	FUSIBILE FUZE	TUBO TUBE	BOCCHIE PORTS	PESO WEIGHT
26 l/min 6.9 gpm	2,5 bar 36 psi	164 720 15	12/24	2	10A / 5A	180W	20A	16 mm	1/2" BSPP	3,7 kg

UP12/E-LOBR



12/24V

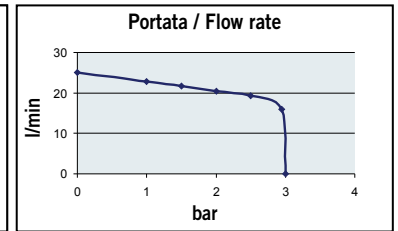
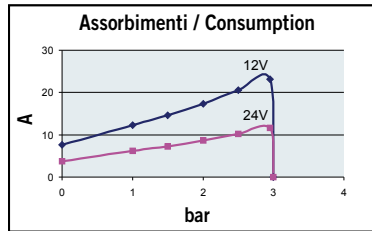
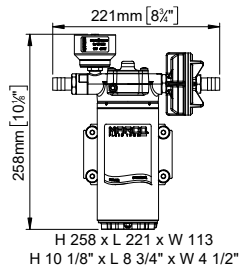

PORTATA FLOW RATE max.	PRESSIONE PRESSURE max.
26 l/min 6.9 gpm	3 bar 43.5 psi

CODICE PART NUMBER	VOLTS	ADESCAM. SELF-PRIM. m	CONS.	MOTORE MOTOR	FUSIBILE FUSE	TUBO TUBE	BOCCHIE PORTS	PESO WEIGHT
164 751 15	12/24	3	8A / 4A	360W	25A	16 mm	1/2" BSPP	4,6 kg

UP12/E-BR



12/24V

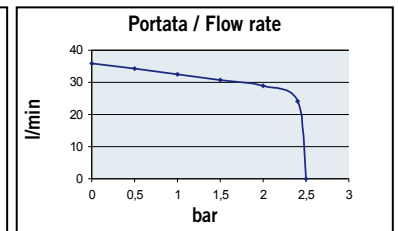
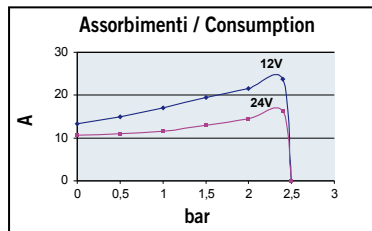
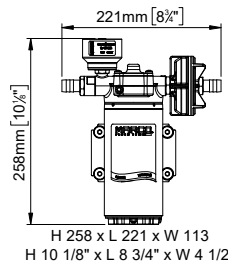

PORTATA FLOW RATE max.	PRESSIONE PRESSURE max.
36 l/min 9.5 gpm	2,5 bar 36 psi

CODICE PART NUMBER	VOLTS	ADESCAM. SELF-PRIM. m	CONS.	MOTORE MOTOR	FUSIBILE FUSE	TUBO TUBE	BOCCHIE PORTS	PESO WEIGHT
164 750 15	12/24	3	14A / 7A	360W	25A	16 mm	1/2" BSPP	4,9 kg

UP14/E-BR



12/24V

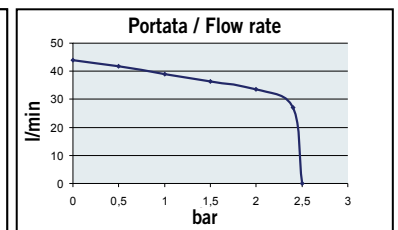
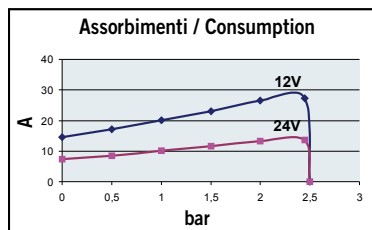
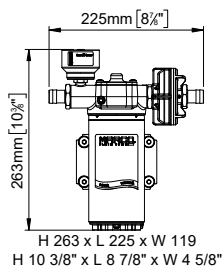

PORTATA FLOW RATE max.	PRESSIONE PRESSURE max.
46 l/min 12 gpm	2,5 bar 36 psi

CODICE PART NUMBER	VOLTS	ADESCAM. SELF-PRIM. m	CONS.	MOTORE MOTOR	FUSIBILE FUSE	TUBO TUBE	BOCCHIE PORTS	PESO WEIGHT
164 760 15	12/24	4	16A / 8A	400W	30A	16 mm	3/4" BSPP	5,2 kg

UP8/E-BR



12/24V

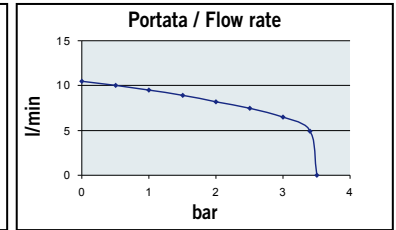
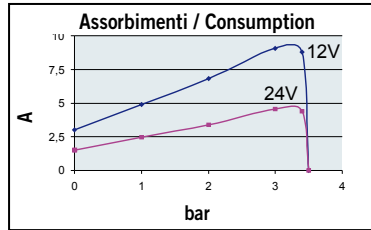
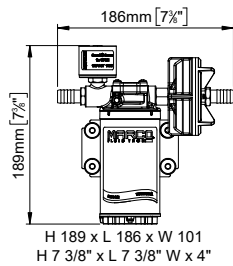

PORTATA FLOW RATE max.	PRESSIONE PRESSURE max.
10 l/min 2.6 gpm	3,5 bar 50.8 psi
HIGH PRESSURE	

CODICE PART NUMBER	VOLTS	ADESCAM. SELF-PRIM. m	CONS.	MOTORE MOTOR	FUSIBILE FUSE	TUBO TUBE	BOCCHIE PORTS	PESO WEIGHT
164 725 15	12/24	1,5	4A / 2A	150W	15A	13 mm	3/8" BSPP	2,1 kg

UP9/E-BR



12/24V

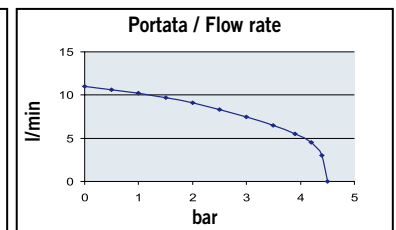
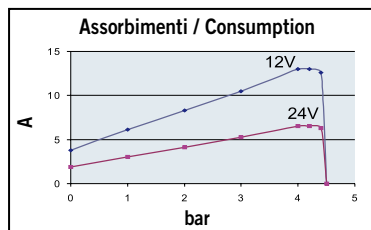
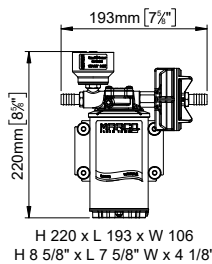

PORTATA FLOW RATE max.	PRESSIONE PRESSURE max.
12 l/min 3.2 gpm	4,5 bar 65.3 psi
HIGH PRESSURE	

CODICE PART NUMBER	VOLTS	ADESCAM. SELF-PRIM. m	CONS.	MOTORE MOTOR	FUSIBILE FUSE	TUBO TUBE	BOCCHIE PORTS	PESO WEIGHT
164 730 15	12/24	1,5	5A / 2,5A	180W	15A	13 mm	3/8" BSPP	3,3 kg

UP10/E-BR



12/24V

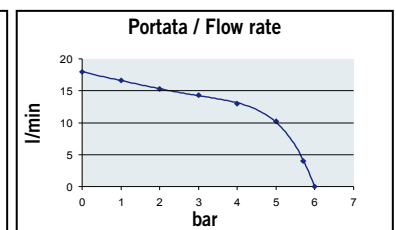
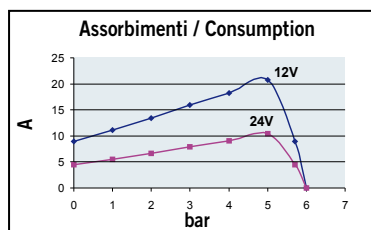
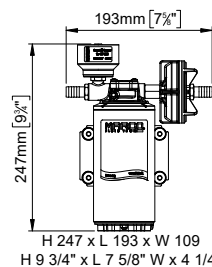

PORTATA FLOW RATE max.	PRESSIONE PRESSURE max.
18 l/min 4.8 gpm	6 bar 87 psi
HIGH PRESSURE	

CODICE PART NUMBER	VOLTS	ADESCAM. SELF-PRIM. m	CONS.	MOTORE MOTOR	FUSIBILE FUSE	TUBO TUBE	BOCCHIE PORTS	PESO WEIGHT
164 740 15	12/24	3	11A / 5,5A	360W	25A	13 mm	3/8" BSPP	4,3 kg

SCS SPEED CONTROL SYSTEM



IT Il pannello di controllo SCS consente di impostare le funzioni della pompa elettronica in modalità DIESEL "High Speed" o in modalità OLIO "Low Speed". Tale impostazione viene mantenuta anche quando il pannello è scollegato.

Caratteristiche:

- Il pannello rende possibile una regolazione fine della velocità massima per ottenere portate differenti o per utilizzare la pompa con liquidi di viscosità diversa da quella preimpostata.
- Monitoraggio a distanza del funzionamento della pompa ed interazione con essa: verifica della presenza di liquido e reset in caso di malfunzionamento senza togliere alimentazione.
- Connessione rapida del pannello al cavo di 3m con attacco RJ11/6 integrato nel sensore della pompa.
- Possibilità di montaggio ad incasso con foro circolare di diametro 70mm o di montaggio esterno.
- Morsetteria che permette di replicare i pulsanti e i LED presenti sul pannello su un circuito esterno: questo permette di gestire in modo personalizzato le funzionalità su un dispositivo progettato da terze parti.

DE Das SCS Kontroll- Paneel ermöglicht es, die elektronische Pumpe auf den Diesel-Modus "High Speed" oder auf den Öl-Modus "Low Speed" einzustellen. Diese Einstellung verändert sich auch bei abgeschaltetem Paneel nicht. Eigenschaften:

- Es erlaubt eine feine Einstellung der Höchstgeschwindigkeit, um verschiedene Förderleistungen zu ermöglichen, oder um die Pumpe für diejenigen Flüssigkeiten zu gebrauchen, die eine andere Viskosität vorweisen als die voreingestellte.
- Fernüberwachung des Pumpenlaufs und deren Fernsteuerung: kontrolliert das Vorhandensein von Flüssigkeit, bei Fehlbetrieb schaltet sich die Reset-Funktion ein, ohne alles ausschalten zu müssen.
- Schnellverbindung des Paneels an das 3m RJ11/6 Kabel, das in dem Pumpensensor integriert ist.
- Einbaumöglichkeit in rundem, 70mm- Durchmesser Loch oder externe Montage.
- Mit dem Verteiler kann man die Knöpfe und LEDs des Paneels auf einen externen Kreis wiedergeben: dieses ermöglicht eine individuelle Einstellung der Funktionen auf einer externen Vorrichtung, die von Dritten entworfen wurde.

FR Le panneau de commande SCS permet le réglage des fonctions de la pompe électronique en mode DIESEL "High Speed" ou en mode OIL "Low Speed". Ce réglage d'origine est conservé même lorsque le panneau est déconnecté.

Les caractéristiques :

- Le panneau permet une mise au point de la vitesse maximale afin d'obtenir différents débits ou d'utiliser la pompe avec des liquides d'une viscosité différent de la programmation original.
- Surveillance à distance de fonctionnement de la pompe et de l'interaction avec elle: la vérification de la présence de liquide et réinitialiser en cas de dysfonctionnement sans débrancher l'appareil.
- Connexion rapide du panneau au câble de 3m avec terminal à l' RJ11/6, intégré dans le capteur de la pompe.
- Le panneau peut être encastré dans un trou circulaire d'un diamètre de 70 mm ou monté à l'extérieur .
- Le bornier permet à l'utilisateur de reproduire les boutons et les LEDs du panneau sur un circuit externe favorisant ainsi une gestion personnalisée des fonctions grâce à un dispositif externe conçu par des tiers.

EN The SCS control panel allows for the setting of the functions of the electronic pump in DIESEL "High Speed" mode or in OIL "Low Speed" mode. This original setting is kept also when the panel is disconnected. Characteristics:

- The panel assures a fine-tuning of the maximum speed in order to obtain various flow rates or to use the pump with liquids of a viscosity different from the original set one.
- Remote monitoring of the pump operation and interaction with it: checking of liquid presence and reset in case of malfunction without disconnecting the device.
- Quick connection of the panel to the 3m RJ11/6 terminal cable integrated in the sensor of the pump.
- The panel can be recessed in a circular hole of a 70mm diameter or externally mounted.
- The terminal block allows the user to replicate the buttons and LEDs of the panel on an external circuit thus favoring a personalized management of the functions through an external device designed by third parties.

ES El panel de control SCS permite la configuración de las funciones de la bomba electrónica en modalidad DIESEL "High Speed" o en modalidad ACEITE "Low Speed". Esta configuración original se mantiene también cuando se desconecta el panel. Características:

- El panel asegura un ajuste fino de la velocidad máxima con el fin de obtener diferentes caudales o para utilizar la bomba con líquidos de una viscosidad diferente de la programada en origen.
- Monitorización remota del funcionamiento de la bomba e interacción con ella: Comprobación de la presencia de líquido y reinicio en caso de avería sin necesidad de desconectar el dispositivo.
- Conexión rápida del panel al cable de 3m con terminal RJ11/6, integrado en el sensor de la bomba.
- El panel puede ser empotrado dentro de un orificio circular de un diámetro de 70 mm o montado externamente.
- El bloque de terminales permite al usuario reproducir los botones y LEDs del panel en un circuito externo: esto permite una gestión personalizada de las funciones a través de un dispositivo externo diseñado por terceros.

PT O painel de controle SCS permite a configuração das funções da bomba eletrônica na modalidade DIESEL "High Speed" ou na modalidade OIL "Low Speed". Esta configuração original é mantida também quando o painel estiver desligado. Características:

- O painel garante um ajuste fino da velocidade máxima de forma a obter diferentes taxas de fluxo ou para se usar a bomba com líquidos de viscosidade diferente do inicialmente programado.
- Monitoramento remoto do funcionamento da bomba e interação com a mesma: verificação da presença de líquido e reinício em caso de funcionamento defeituoso sem desligar o dispositivo.
- Ligação rápida do painel ao cabo de 3m com terminal RJ11 / 6, integrado no sensor da bomba.
- O painel pode ser embutido num orifício circular com um diâmetro de 70 mm ou montado externamente.
- Um bloco de terminais permite replicar os botões e LEDs do painel num circuito externo: isto permite controlar individualmente as funções num dispositivo projetado por terceiros.

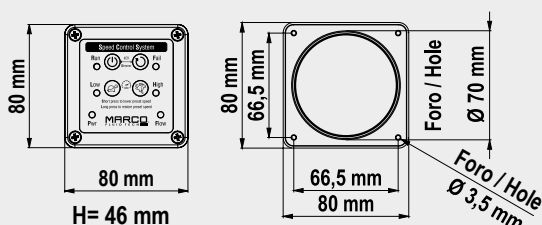

TIPO TYPE	CODICE PART NUMBER	VOLT	CONNESSIONE CONNECTION	PROTEZIONE PROTECTION	DIMENSIONI DIMENSIONS mm	FORO HOLE mm
SCS	165 204 15	12/24	RJ11	IP65	80 x 80 x 46	Ø 70

12/24V REVERSIBLE ELECTRONIC PUMPS

UP8-RE

Smart Keypad



▪ Integrated Smart Keypad for Flow Rate Fine Tuning



12/24V

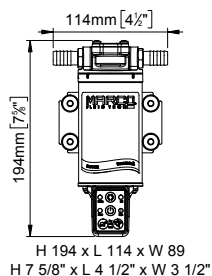

H 194 x L 114 x W 89
H 7 5/8" x L 4 1/2" x W 3 1/2"

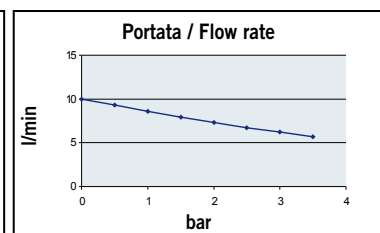
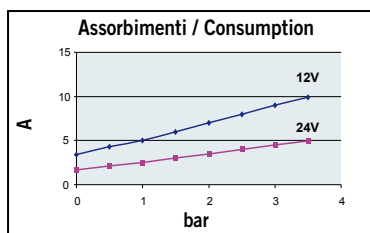

PORTATA FLOW RATE max.

PRESSIONE PRESSURE max.

10 l/min
2.6 gpm

3,5 bar
50.8 psi

HIGH PRESSURE

CODICE PART NUMBER	VOLTS	ADESCAM. SELF-PRIM. m	CONS.	MOTORE MOTOR	FUSIBILE FUSE	TUBO TUBE	BOCCHE PORTS	PESO WEIGHT
164 095 15	12/24	1,5	4A / 2A	150W	15A	13 mm	3/8" BSPP	2,2 kg

UP3-RK

RCS Panel see page 75



▪ Available with 1 or 2 valves



(see page 79)



12/24V

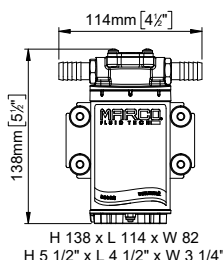

H 138 x L 114 x W 82
H 5 1/2" x L 4 1/2" x W 3 1/4"

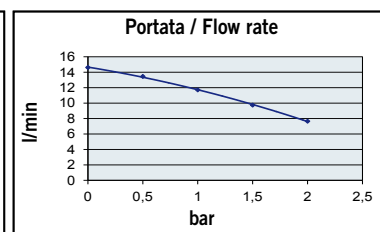
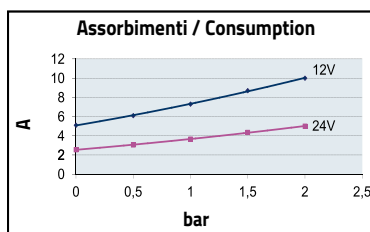

PORTATA FLOW RATE max.

PRESSIONE PRESSURE max.

15 l/min
4 gpm

2 bar
29 psi

CODICE PART NUMBER	VOLTS	ADESCAM. SELF-PRIM. m	CONS.	MOTORE MOTOR	FUSIBILE FUSE	TUBO TUBE	BOCCHE PORTS	PESO WEIGHT
164 005 15	12/24	1,5	6A / 3A	120W	10A	13 mm	3/8" BSPP	2,1 kg

UP6-RK

RCS Panel see page 75



▪ Available with 1 or 2 valves



(see page 79)



12/24V

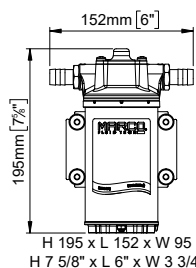

H 195 x L 152 x W 95
H 7 5/8" x L 6" x W 3 3/4"

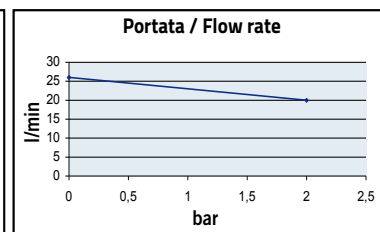
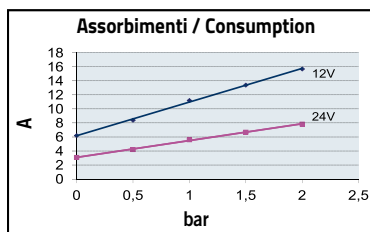

PORTATA FLOW RATE max.

PRESSIONE PRESSURE max.

20 l/min
5.3 gpm

2 bar
29 psi

CODICE PART NUMBER	VOLTS	ADESCAM. SELF-PRIM. m	CONS.	MOTORE MOTOR	FUSIBILE FUSE	TUBO TUBE	BOCCHE PORTS	PESO WEIGHT
164 064 15	12/24	2	7A / 3,5A	180W	10A	16 mm	1/2" BSPP	3,6 kg

BRONZE GEAR PUMPS

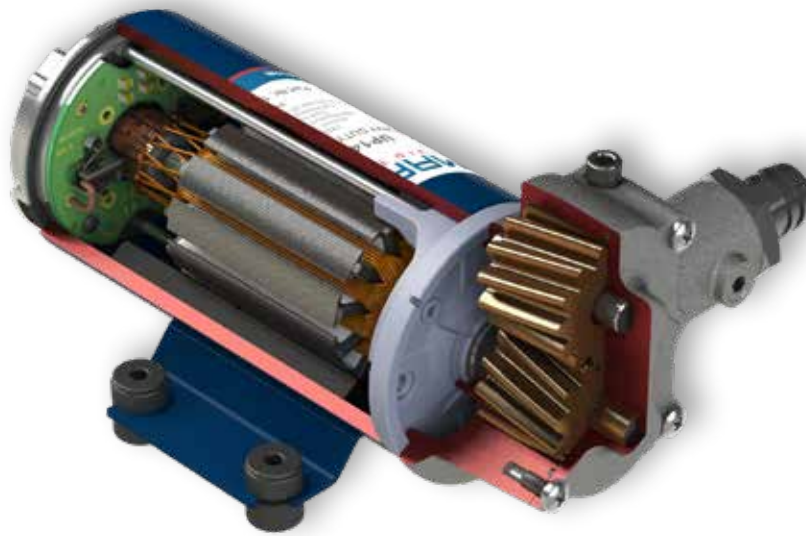

BRONZE GEARS

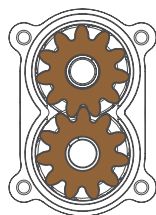

REVERSIBLE



IT Elettropompe ad ingranaggi in bronzo per travaso di oli lubrificanti o di liquidi viscosi. Gli ingranaggi elicoidali in bronzo garantiscono pressione costante, cicli di lavoro prolungati, maggiore silenziosità e possono operare anche in mancanza di liquido. Corpo in ottone nichelato, albero in acciaio inossidabile. Tenute in FKM e O-ring in NBR. Disponibili in versioni con interruttore o deviatore integrati, kit con interruttore cavi e pinze per batteria e kit con controllo elettronico.

DE Selbstansaugende, kleine Elektropumpen mit Bronzeshnradern, zum Umfüllen von Ölen oder dickflüssigen Flüssigkeiten. Die Bronze- Schräg Zahnräder garantieren konstanten Druck, verlängerte Arbeitszyklen, sind geräuschloser und können auch ohne Flüssigkeit arbeiten. Gehäuse aus vernickeltem Messing, Spindel aus rostfreiem Stahl. Dichtungen aus FKM, O-Ringe aus NBR. Erhältlich entweder mit integriertem Ein- und Aus Schalter oder 3-Positionen- Schalter, oder Kit mit Schalter, Kabel und Batterie zangen, oder Kit mit elektronischer Kontrolle.

FR Pompes électriques auto-amorçantes avec engrenages en bronze pour transvasement d'huiles lubrifiants et de liquides visqueux. Les engrenages hélicoïdaux en bronze assurent une pression constante, des cycles de travail longs, moins de bruit et peuvent également fonctionner en l'absence de liquide. Corps en laiton nickelé et arbre en acier inoxydable. Joint en FKM et O-Ring en NBR. Disponibles en versions avec interrupteur ou déviateur intégrés, kit avec interrupteur et pinces pour batterie, et kit avec contrôle électronique.

EN Self-priming electric pumps with bronze gears to transfer lubricating oils and viscous liquids. Helical bronze gears guarantee constant pressure, heavy duty cycles, less noise and can operate in the absence of liquid. Nickel-plated brass body and stainless steel shaft. FKM seals and NBR O-rings. Available in versions with integrated on-off switch or flow reverser switch, kit with on-off switch and battery clips, and kit with electronic control.

ES Electrobombas auto cebadas con engranajes en bronce para transvase aceites lubricantes o líquidos viscosos. Los engranajes helicoidales de bronce garantizan presión constante, largos ciclos de trabajo, menos ruido y pueden operar en ausencia de líquido. Cuerpo en latón niquelado, eje en acero inoxidable. Sellos en FKM y O-ring and NBR. Disponibles en versiones con interruptor o desviador de flujo integrados, Kit con interruptor y pinzas para batería y Kit con control electrónico.

PT Eletrobombas autoaspirantes com engrenagens em bronze para trasfega de óleos lubrificantes e líquidos viscosos. As engrenagens helicoidais de bronze garantem uma pressão constante, longos ciclos de trabalho, menos ruído e também podem funcionar, sem líquido. Corpo em latão niquelado, eixo em aço inox. Selos de FKM e O-ring de NBR. Disponíveis em versões com interruptor on-off ou desviador de fluxo integrados, kit com interruptor e pinças de bateria, e kit com controle eletrônico.

Spare parts and accessories

Page 79

OK1



BRONZE GEARS

12V and 24V - DC

UP2/OIL



12V

24V

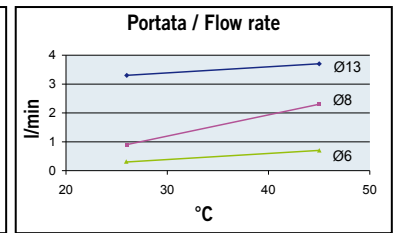
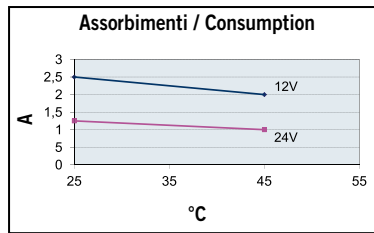
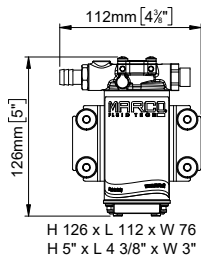

PORTATA*
FLOW RATE*
max.

PRESSIONE
PRESSURE
max.

3,3 l/min
0.9 gpm

1,5 bar
22 psi

* OIL SAE 30 AT 25°C

CODICE
PART NUMBER

VOLTS

ADESCAM.
SELF-PRIM.
m

CONS.

MOTORE
MOTOR

FUSIBILE
FUSE

TUBO
TUBE

BOCCHE
PORTS

PESO
WEIGHT

164 220 12

12

1

2,5A

90W

3A

12 mm

3/8" BSPP

1,2 kg

164 220 13

24

1

1,3A

90W

1,5A

12 mm

3/8" BSPP

1,2 kg

UP3/OIL



12V

24V

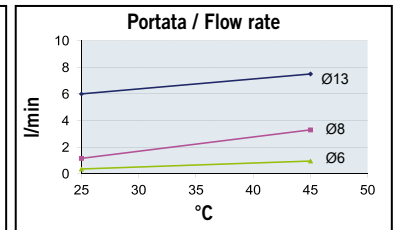
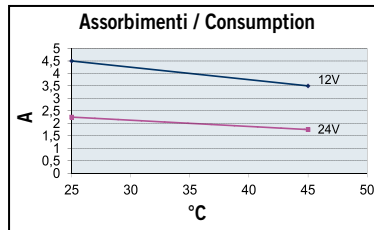
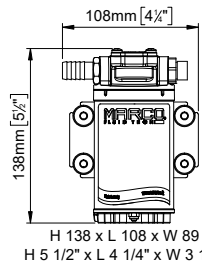

PORTATA*
FLOW RATE*
max.

PRESSIONE
PRESSURE
max.

5,5 l/min
1.5 gpm

2 bar
29 psi

* OIL SAE 30 AT 25°C

CODICE
PART NUMBER

VOLTS

ADESCAM.
SELF-PRIM.
m

CONS.

MOTORE
MOTOR

FUSIBILE
FUSE

TUBO
TUBE

BOCCHE
PORTS

PESO
WEIGHT

164 020 12

12

1

5A

90W

7,5A

13 mm

3/8" BSPP

1,4 kg

164 020 13

24

1

3A

90W

4A

13 mm

3/8" BSPP

1,4 kg

UP3/OIL-R



On/Off 3 positions
reversing switch



12V

24V

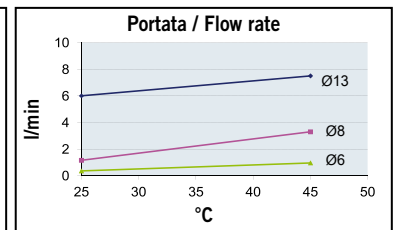
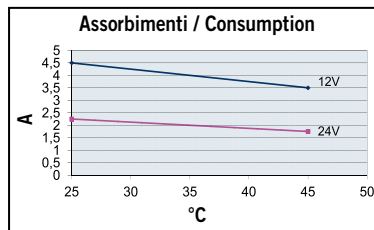
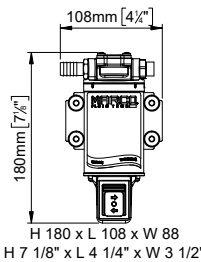

PORTATA*
FLOW RATE*
max.

PRESSIONE
PRESSURE
max.

5,5 l/min
1.5 gpm

2 bar
29 psi

* OIL SAE 30 AT 25°C

CODICE
PART NUMBER

VOLTS

ADESCAM.
SELF-PRIM.
m

CONS.

MOTORE
MOTOR

FUSIBILE
FUSE

TUBO
TUBE

BOCCHE
PORTS

PESO
WEIGHT

164 022 12

12

1

5A

90W

7,5A

13 mm

3/8" BSPP

1,8 kg

164 022 13

24

1

3A

90W

4A

13 mm

3/8" BSPP

1,8 kg

UP6/OIL



12V
24V

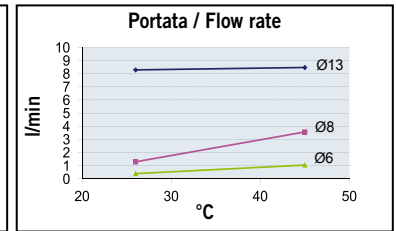
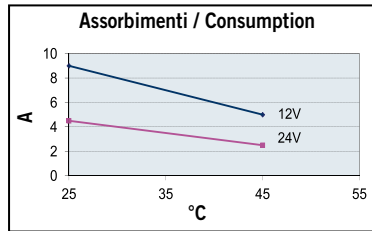
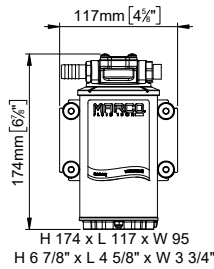

PORTATA*
FLOW RATE*
max.

PRESSIONE
PRESSURE
max.

8 l/min
2.1 gpm

5 bar
72.5 psi

* OIL SAE 30
AT 25°C

HIGH PRESSURE

CODICE PART NUMBER	VOLTS	ADESCAM. SELF-PRIM. m	CONS.	MOTORE MOTOR	FUSIBILE FUSE	TUBO TUBE	BOCCHIE PORTS	PESO WEIGHT
164 080 12	12	1,5	7A	180W	10A	13 mm	3/8" BSPP	2,5 kg
164 080 13	24	1,5	4A	180W	7,5A	13 mm	3/8" BSPP	2,5 kg

UP12/OIL



12V
24V

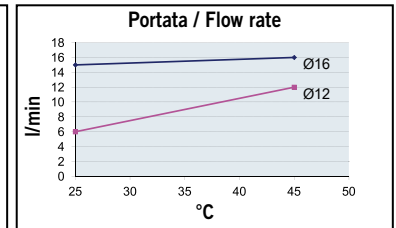
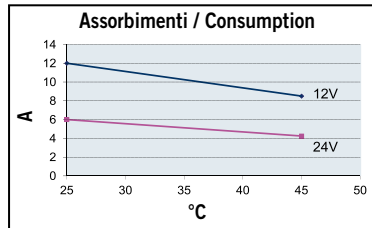
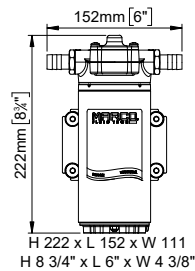

PORTATA*
FLOW RATE*
max.

PRESSIONE
PRESSURE
max.

15 l/min
4 gpm

3 bar
43.5 psi

* OIL SAE 30
AT 25°C

CODICE PART NUMBER	VOLTS	ADESCAM. SELF-PRIM. m	CONS.	MOTORE MOTOR	FUSIBILE FUSE	TUBO TUBE	BOCCHIE PORTS	PESO WEIGHT
164 320 12	12	2	11A	180W	15A	16 mm	1/2" BSPP	4,5 kg
164 320 13	24	2	6A	180W	7,5A	16 mm	1/2" BSPP	4,5 kg

UP12-LO

■ For light oils



12V
24V

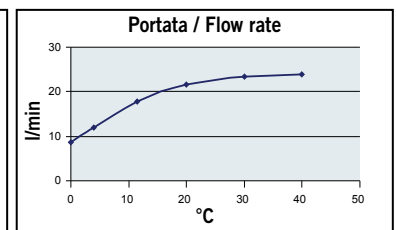
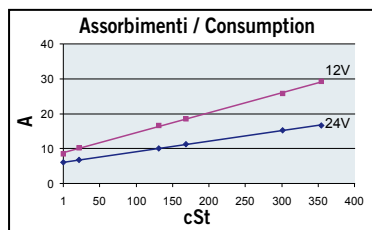
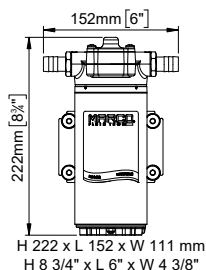

PORTATA**
FLOW RATE**
max.

PRESSIONE
PRESSURE
max.

22 l/min
5.8 gpm

3 bar
43.5 psi

** T46 OIL

CODICE PART NUMBER	VOLTS	ADESCAM. SELF-PRIM. m	CONS.	MOTORE MOTOR	FUSIBILE FUSE	TUBO TUBE	BOCCHIE PORTS	PESO WEIGHT
164 322 12	12	3	19A	360W	25A	16 mm	1/2" BSPP	4,5 kg
164 322 13	24	3	11A	360W	15A	16 mm	1/2" BSPP	4,5 kg

UP12-LOCK

- For light oils
- Portable kit with battery clips

I On/Off switch
0



12V
24V

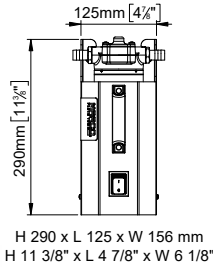

H 290 x L 125 x W 156 mm
H 11 3/8" x L 4 7/8" x W 6 1/8"

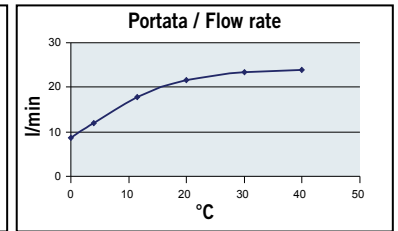
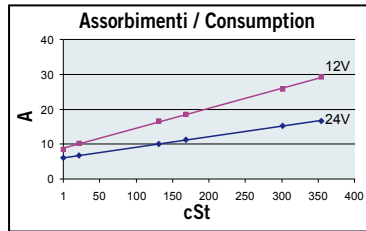

PORTATA**
FLOW RATE**
max.

PRESSIONE
PRESSURE
max.

22 l/min
5.8 gpm

3 bar
43.5 psi

** T46 OIL

CODICE PART NUMBER	VOLTS	ADESCAM. SELF-PRIM. m	CONS.	MOTORE MOTOR	FUSIBILE FUSE	TUBO TUBE	BOCCHIE PORTS	PESO WEIGHT
164 324 12	12	3	19A	360W	25A	16 mm	1/2" BSPP	6 kg
164 324 13	24	3	11A	360W	15A	16 mm	1/2" BSPP	6 kg

UP14/OIL



12V
24V

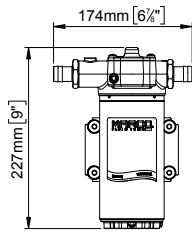

H 227 x L 174 x W 119
H 9" x L 6 7/8" x W 4 5/8"

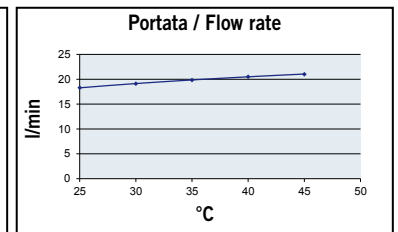
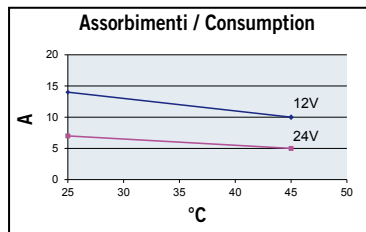

PORTATA*
FLOW RATE*
max.

PRESSIONE
PRESSURE
max.

18,3 l/min
4.8 gpm

2 bar
29 psi

* OIL SAE 30
AT 25°C

CODICE PART NUMBER	VOLTS	ADESCAM. SELF-PRIM. m	CONS.	MOTORE MOTOR	FUSIBILE FUSE	TUBO TUBE	BOCCHIE PORTS	PESO WEIGHT
164 520 12	12	2	14A	260W	20A	20 mm	3/4" BSPP	5,3 kg
164 520 13	24	2	7A	260W	15A	20 mm	3/4" BSPP	5,3 kg

FLEXIBLE IMPELLER 12V and 24V - DC

UP1-J/OIL

- FKM Impeller
- Low speed
- Special for oil change

NEW



12V
24V

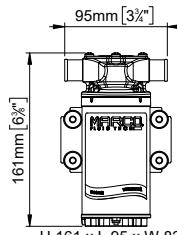

H 161 x L 95 x W 82
H 6 3/8" x L 3 3/4" x W 3 1/4"

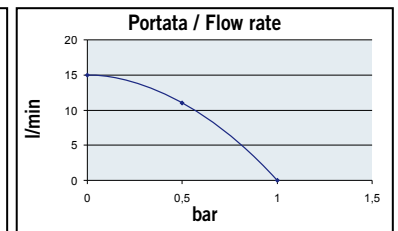
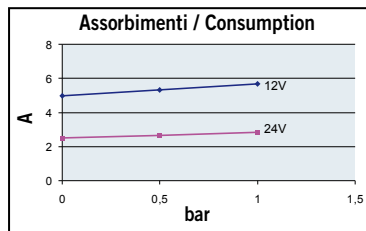

PORTATA*
FLOW RATE*
max.

PRESSIONE
PRESSURE
max.

15 l/min
4 gpm

1 bar
14.5 psi

* OIL SAE 30 AT 25°C

CODICE PART NUMBER	VOLTS	ADESCAM. SELF-PRIM. m	CONS.	MOTORE MOTOR	FUSIBILE FUSE	TUBO TUBE	BOCCHIE PORTS	PESO WEIGHT
162 005 12	12	1	5A	120W	7,5A	20 mm	3/8" BSPP	1,8 kg
162 005 13	24	1	2,5A	120W	4A	20 mm	3/8" BSPP	1,8 kg

BRONZE GEARS

230V and 400V - AC

UP6/OIL-AC

NEW



230V
400V

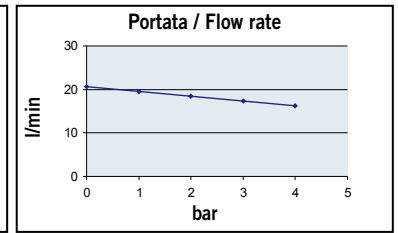
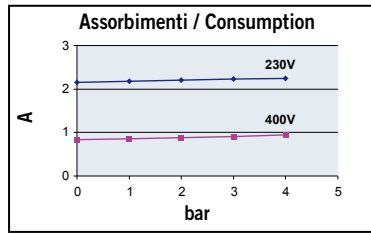
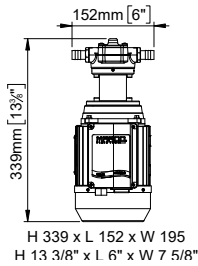

	PORTATA FLOW RATE max.	PRESSIONE PRESSURE max.
230V	14 l/min 3.7 gpm	5 bar 72.5 psi
400V	14 l/min 3.7 gpm	5 bar 72.5 psi

CODICE PART NUMBER	VOLT	ADESCAM. SELF-PRIM. m	CONS.	MOTORE MOTOR	FUSIBILE FUSE	TUBO HOSE	BOCCHIE PORTS	PESO WEIGHT
164 081 1C	230	1	2A	370W	3A	16 mm	1/2" BSPP	7,6 kg
164 081 1F	400	1,5	0,8A	370W	1A	16 mm	1/2" BSPP	7,6 kg

UP14/OIL-AC

NEW



230V
400V

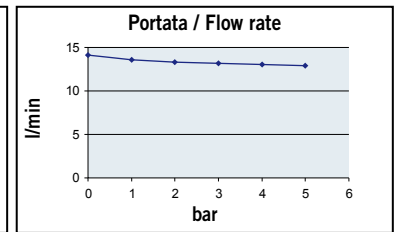
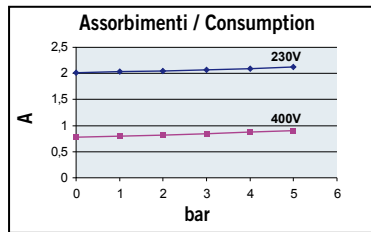
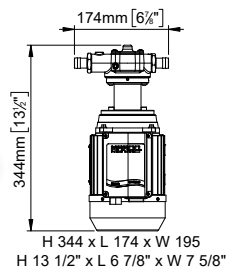

	PORTATA FLOW RATE max.	PRESSIONE PRESSURE max.
230V	21 l/min 5.5 gpm	4 bar 58 psi
400V	21 l/min 5.5 gpm	4 bar 58 psi

CODICE PART NUMBER	VOLT	ADESCAM. SELF-PRIM. m	CONS.	MOTORE MOTOR	FUSIBILE FUSE	TUBO HOSE	BOCCHIE PORTS	PESO WEIGHT
164 521 1C	230	3	2,1A	370W	3A	19 mm	3/4" BSPP	8,1 kg
164 521 1F	400	3	0,8A	370W	1A	19 mm	3/4" BSPP	8,1 kg

12/24V OIL CHANGE KITS

OCK1

▪ Complete kit with battery clips



12V
24V

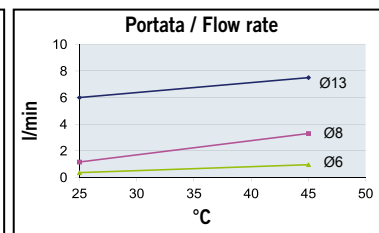
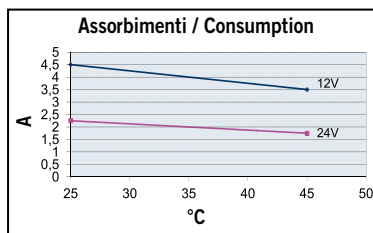
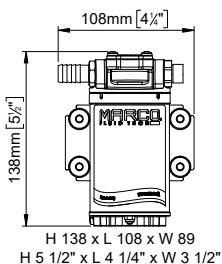

PORTATA*
FLOW RATE*
max.

PRESSIONE
PRESSURE
max.

5,5 l/min
1.5 gpm

2 bar
29 psi

* OIL SAE 30
AT 25°C

CODICE PART NUMBER	VOLTS	ADESCAM. SELF-PRIM. m	CONS.	MOTORE MOTOR	FUSIBILE FUZE	TUBO TUBE	BOCCHIE PORTS	PESO WEIGHT
164 930 12	12	1	6A	90W	10A	13 mm	3/8" BSPP	1,7 kg
164 930 13	24	1	3A	90W	5A	13 mm	3/8" BSPP	1,7 kg

OCK1-R

▪ Complete kit with battery clips

On/Off 3 positions
reversing switch

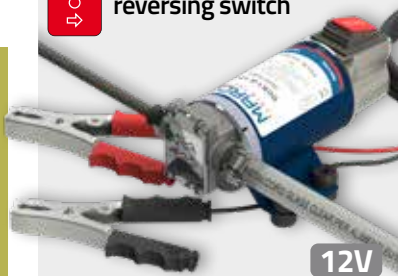

12V
24V

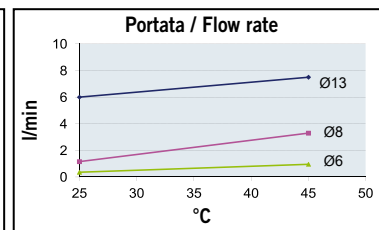
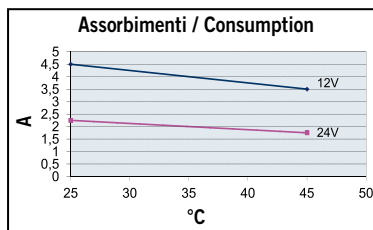
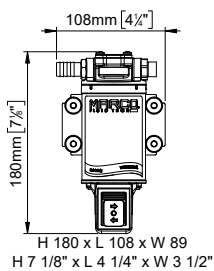

PORTATA*
FLOW RATE*
max.

PRESSIONE
PRESSURE
max.

5,5 l/min
1.5 gpm

2 bar
29 psi

* OIL SAE 30
AT 25°C

CODICE PART NUMBER	VOLTS	ADESCAM. SELF-PRIM. m	CONS.	MOTORE MOTOR	FUSIBILE FUZE	TUBO TUBE	BOCCHIE PORTS	PESO WEIGHT
164 932 12	12	1	5A	90W	10A	13 mm	3/8" BSPP	1,4 kg
164 932 13	24	1	3A	90W	5A	13 mm	3/8" BSPP	1,4 kg

12/24V ELECTRONIC OIL CHANGE KITS

IT Pompe e sistemi reversibili con controllo elettronico per operazioni di travaso e cambio olio. Il controllo elettronico regola la velocità del motore della pompa in base alla viscosità/temperatura dell'olio e aumenta il numero di giri nella fase di adescamento per maggiore rapidità dell'operazione. Il sistema va in blocco automatico in caso di fine liquido, cortocircuito e dopo 30 minuti di operatività.

DE Pumpen und reversible Systeme mit elektronischer Kontrolle zum Umfüllen und Wechsel von Öl. Automatische Geschwindigkeitsregulierung des Motors je nach Dickflüssigkeit/Temperatur des Öles. Um die Ansaugphase zu verkürzen, wird die Drehzahl erhöht. Das System wird automatisch blockiert bei Fehlen der Flüssigkeit, bei Kurzschluss und nach 30 Minuten Arbeitszeit.

FR Pompes et systèmes réversibles avec contrôle électronique pour vidanger et changer l'huile. Le contrôle électronique règle la vitesse du moteur selon la viscosité/température de l'huile et de plus augmente le numéro de tours-moteur dans la phase d'amorçage pour une rapidité opérative. Le système est bloqué automatiquement en cas de réservoir vide, court-circuit et après 30 min. de fonctionnement.

EN Reversible electronic pumps and systems for oil fill and drain operations. The electronic control adjusts the speed of the motor according to oil viscosity/temperature and increases its speed during priming for faster operations. The system automatically shuts off in case of empty tank, short circuit and after 30 minutes of operation.

ES Bombas y sistemas reversibles con control electrónico para el vaciado/llenado de aceite. El control electrónico adapta la velocidad del motor a la viscosidad/temperatura del aceite. También aumenta la velocidad de la bomba en fase de cebadura para mejorar la velocidad de las operaciones. El sistema se para automáticamente en caso de tanque vacío, cortocircuito y después de 30 minutos de trabajo.

PT Bombas e sistemas reversíveis com controle eletrônico para o rápido esvaziamento e enchimento do óleo. O controle eletrônico regula a velocidade do motor conforme a viscosidade/temperatura do óleo, além disso aumenta o número das voltas na fase de aspiração para uma maior velocidade operativa. O sistema entra em bloqueio automático no caso do líquido acabar ou de curto-circuito, e depois de 30 min. de trabalho.

Spare parts and accessories

OCP1/3



OCP2/3



OCP1/6



OCP2/6



Page 79

OCK8-E

Smart Keypad



12/24V

- Integrated Smart Keypad for fine tuning
- Reversible
- Complete kit with battery clips

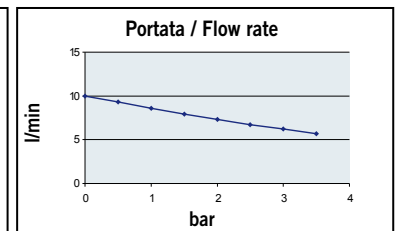
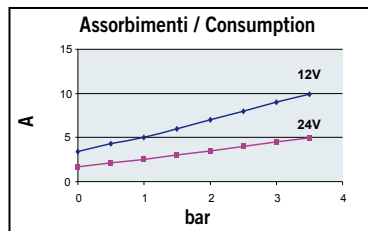
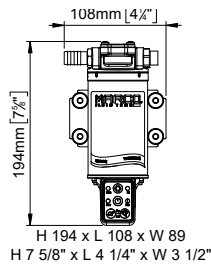

PORTATA
FLOW RATE
max.

10 l/min
2.6 gpm

PRESSIONE
PRESSURE
max.

3,5 bar
50.8 psi

HIGH PRESSURE

CODICE PART NUMBER	VOLTS	ADESCAM. SELF-PRIM. m	CONS.	MOTORE MOTOR	FUSIBILE FUSE	TUBO TUBE	BOCCHIE PORTS	PESO WEIGHT
164 936 15	12/24	1,5	4A / 2A	150W	15A	13 mm	3/8" BSPP	2,2 kg

OCK1-E

- Reversible
- Complete kit with battery clips



12/24V

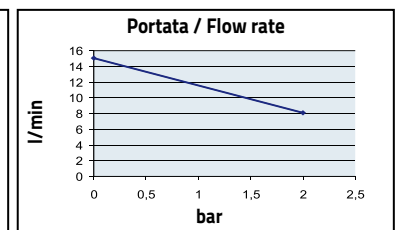
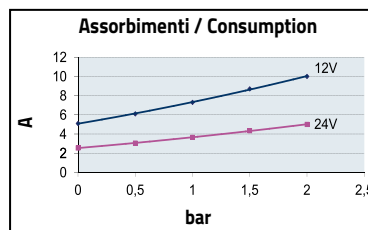
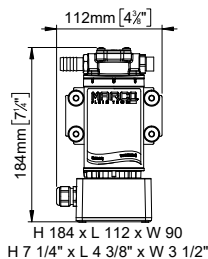

PORTATA
FLOW RATE
max.

15 l/min
4 gpm

PRESSIONE
PRESSURE
max.

2 bar
29 psi

CODICE PART NUMBER	VOLT	ADESCAM. SELF-PRIM. m	CONS.	MOTORE MOTOR	FUSIBILE FUSE	TUBO HOSE	BOCCHIE PORTS	PESO WEIGHT
164 931 15	12/24	1	6A / 3A	120W	7,5A	13 mm	3/8" BSPP	2,4 kg

OCS3/E

▪ 3 valves ▪ Reversible



12/24V

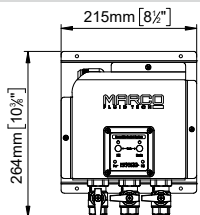

H 264 x L 215 x W 114
H 10 3/8" x L 8 1/2" x W 4 1/2"

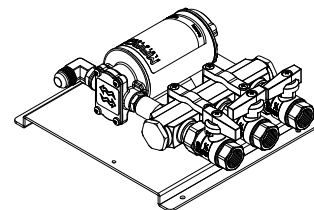

PORTATA
FLOW RATE
max.

PRESSIONE
PRESSURE
max.

10 l/min
2.6 gpm

2 bar
29 psi

CODICE
PART NUMBER

VOLTS

ADESCAM.
SELF-PRIM.
m

CONS.

MOTORE
MOTOR

FUSIBILE
FUSE

BOCCHIE
PORTS

PESO
WEIGHT

164 924 15

12/24

1,5

4A / 2A

120W

10A

1/2" BSPP

4,4 kg

OCS5/E

▪ 5 valves ▪ Reversible



12/24V

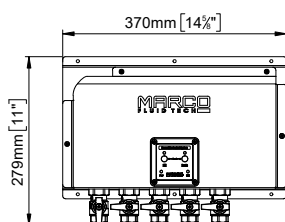

H 279 x L 370 x W 124
H 11" x L 14 5/8" x W 4 7/8"

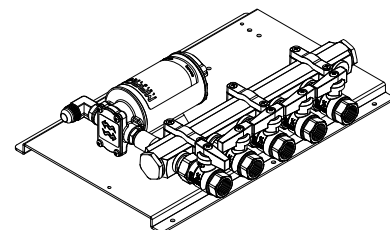

PORTATA
FLOW RATE
max.

PRESSIONE
PRESSURE
max.

10 l/min
2.6 gpm

2 bar
29 psi

CODICE
PART NUMBER

VOLTS

ADESCAM.
SELF-PRIM.
m

CONS.

MOTORE
MOTOR

FUSIBILE
FUSE

BOCCHIE
PORTS

PESO
WEIGHT

164 925 15

12/24

1,5

4A / 2A

120W

10A

1/2" BSPP

6,5 kg

OCS6/E

▪ 6 valves ▪ Reversible



12/24V

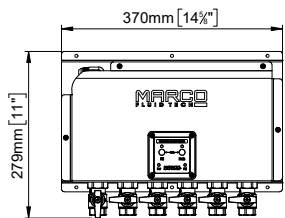

H 279 x L 370 x W 124
H 11" x L 14 5/8" x W 4 7/8"

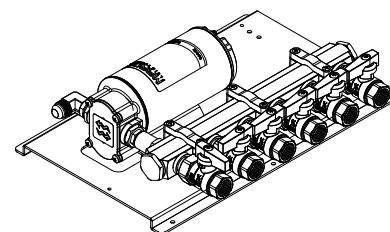

PORTATA
FLOW RATE
max.

PRESSIONE
PRESSURE
max.

20 l/min
5.3 gpm

2 bar
29 psi

CODICE
PART NUMBER

VOLTS

ADESCAM.
SELF-PRIM.
m

CONS.

MOTORE
MOTOR

FUSIBILE
FUSE

BOCCHIE
PORTS

PESO
WEIGHT

164 926 15

12/24

1,5

7A / 3,5A

180W

10A

1/2" BSPP

8 kg

OCS9/E

▪ 9 valves ▪ Reversible



12/24V

100-240V

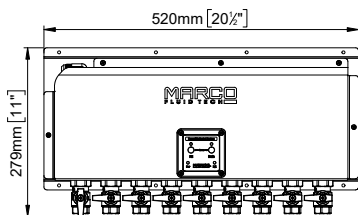

H 279 x L 520 x W 124
H 11" x L 20 1/2" x W 4 7/8"

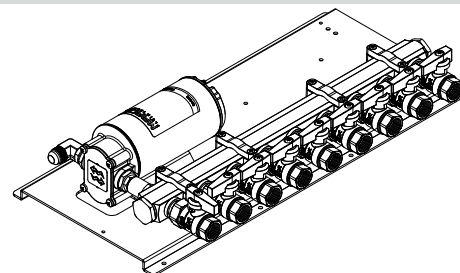

PORTATA
FLOW RATE
max.

PRESSIONE
PRESSURE
max.

20 l/min
5.3 gpm

2 bar
29 psi

CODICE
PART NUMBER

VOLTS

ADESCAM.
SELF-PRIM.
m

CONS.

MOTORE
MOTOR

FUSIBILE
FUSE

BOCCHIE
PORTS

PESO
WEIGHT

164 928 15

12/24

1,5

7A / 3,5A

180W

10A

1/2" BSPP

10 kg

164 928 1H

100-240

1,5

0,3A

180W

1A

1/2" BSPP

10,8 kg

RCS REVERSIBLE CONTROL SYSTEM

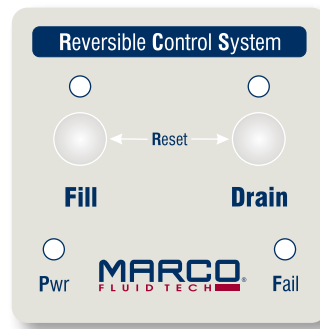

IT Il pannello di controllo RCS, integrato nelle pompe e nei sistemi di travaso e cambio olio, permette di monitorare il funzionamento della pompa ed interagire con essa. Caratteristiche:

- Reversibilità della direzione del flusso che permette due modalità operative: DRAIN per l'aspirazione e FILL per il riempimento.
- Regolazione automatica della velocità del motore in base alla viscosità e alla temperatura del liquido.
- Arresto e riavvio della pompa con la semplice pressione di un tasto.
- Reset istantaneo tramite la pressione simultanea dei due tasti operativi (DRAIN e FILL).
- Arresto automatico dopo 30 secondi in caso di olio troppo viscoso o rubinetto chiuso.
- Arresto automatico dopo 90 secondi dal termine del travaso, quando la pompa è vuota.
- Arresto automatico dopo 30 minuti di funzionamento senza interruzioni (opzione disattivabile direttamente dal pannello).
- Segnalazioni operative tramite LED luminosi.
- Possibilità di impostazione "High Speed" per travaso diesel.

DE Das RCS-Kontrollpaneel, das in den Pumpen und in den Umfüll- und Ölwechselsystemen integriert ist, ermöglicht die Kontrolle der Pumpentätigkeit, sowie eine Interaktion. Eigenschaften:

- Flüssigkeit kann in zwei Richtungen fließen: DRAIN-Modus beim Absaugen und FILL-Modus beim Einfüllen
- automatische Geschwindigkeitsregelung des Motors je nach Zähflüssigkeitsgrad und Temperatur
- Stoppen und Starten der Pumpe wird mit einem Knopfdruck betätigt
- unmittelbares Resetieren erfolgt mit simultanem Drücken der beiden Tasten DRAIN und FILL
- bei allzu zähflüssigem Öl oder bei geschlossenem Hahn erfolgt ein automatischer Stop nach 30 Sekunden
- automatischer Stop nach 90 Sekunden, wenn nach dem Umfüllen die Pumpe leer ist
- automatischer Stop nach 30 Minuten ununterbrochener Arbeit (kann man, wenn unerwünscht, direkt am Paneel ausschalten)
- LED-Anzeige bei leerem Behälter
- "High speed" Einstellungsmöglichkeit für Dieselumfüllung

FR Le panneau de contrôle RCS, intégré dans les pompes à huile et les systèmes de changement d'huile vous permet de surveiller à distance le fonctionnement de la pompe et d'interagir avec elle. Caractéristiques:

- Réversibilité du sens d'écoulement, ce qui permet deux modes de fonctionnement : DRAIN pour l'aspiration et FILL pour le remplissage.
- Régulation automatique de la vitesse du moteur en fonction de la viscosité et de la température du liquide.
- Arrêt et démarrage de la pompe avec une simple pression sur un bouton.
- Réinitialisation immédiate en appuyant sur les boutons DRAIN et FILL à la fois.
- Arrêt automatique au bout de 30 secondes en présence d'huile avec une viscosité excessive ou robinet fermé.
- Arrêt automatique au bout de 90 secondes de la fin de l'opération lorsque la pompe est vide.
- Arrêt automatique au bout de 30 minutes de fonctionnement continu (cette option peut être désactivée directement depuis le panneau).
- Les opérations sont signalées par des LEDs lumineuses.
- Possibilité de réglage "High Speed" pour le transvasement de diesel.

EN The RCS control panel integrated in the oil pumps and oil change systems allows you to remotely monitor the operation of the pump and interact with it. Features:

- The reversibility of flow direction allows for two operative modes: DRAIN for aspiration and FILL for filling.
- Automatic regulation of the motor speed according to viscosity and temperature of the liquid.
- Stop and Start of the pump with a simple push of a button.
- Immediate reset by pressing the DRAIN and FILL buttons at the same time.
- Automatic stop after 30 seconds in presence of oil with excessive viscosity or closed tap.
- Automatic stop after 90 seconds from the end of the operation when the pump is empty.
- Automatic stop after 30 minutes of continuous operation (this option can be deactivated directly from the panel).
- Operations are signaled by luminous LEDs.
- Possibility of "High Speed" setting for diesel transfer.

ES El panel de control RCS integrado en las bombas de aceite y en los sistemas de cambio de aceite permite controlar a distancia el funcionamiento de la bomba e interactuar con ella. Características:

- Reversibilidad de la dirección del flujo a través de dos modos operativos: DRAIN para aspiración y FILL para llenado.
- Regulación automática de la velocidad del motor de acuerdo con la viscosidad y la temperatura del líquido.
- Apagamiento e reinicio de la bomba con una simple pulsación de un botón.
- Reajuste inmediato pulsando los botones DRAIN y FILL al mismo tiempo.
- Parada automática después de 30 segundos en presencia de aceite con una viscosidad excesiva o grifo cerrado.
- Parada automática después de 90 segundos desde el final de la operación cuando la bomba está vacía.
- Parada automática después de 30 minutos de funcionamiento continuo (esta opción se puede desactivar directamente desde el panel).
- Las operaciones se indican mediante LEDs luminosos.
- Posibilidad de ajuste al modo "High Speed" para transvase de diésel.

PT O painel de controle RCS integrado nas bombas de óleo e nos sistemas de mudança de óleo permite monitorar remotamente o funcionamento da bomba e interagir com a mesma. Características:

- Dois modos operativos: DRAIN para aspiração e FILL para enchimento, com possibilidade de inversão do sentido de fluxo.
- Regulação automática da velocidade do motor conforme a viscosidade e a temperatura do líquido.
- Paragem e arranque da bomba com uma simples pressão dum botão.
- Redefinição imediata pressionando os botões DRAIN e FILL ao mesmo tempo.
- Paragem automática depois de 30 segundos em presença de óleo com viscosidade excessiva ou torneira fechada.
- Paragem automática depois de 90 segundos a partir do final da operação, quando a bomba está vazia.
- Paragem automática depois de 30 minutos de operação contínua (esta opção pode ser desativada diretamente no painel).
- As operações são sinalizadas por LEDs luminosos.
- Possibilidade de definir o modo "High Speed" para trasfega de diesel.

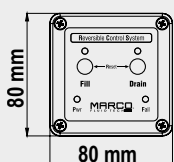

H= 46 mm

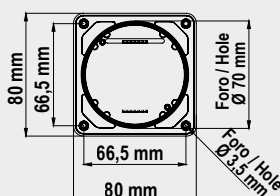

TIPO TYPE	CODICE PART NUMBER	VOLT	DESCRIZIONE DESCRIPTION	PROTEZIONE PROTECTION	DIMENSIONI DIMENSIONS mm	FORO HOLE mm
RCS	165 201 15	12/24	for UP3-RK	IP67	80 x 80 x 46	Ø 70
	165 202 15	12/24	for UP6-RK	IP67	80 x 80 x 46	Ø 70

AS3

NEW



▪ Heavy duty

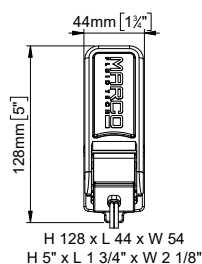

- IT** Interruttore automatico per pompe sentina . Ideale per servizi gravosi.
- EN** Automatic float switch for bilge pumps - Heavy Duty.
- DE** Automatischer Schalter für Lenzpumpen - Heavy Duty.
- ES** Interruptor automático para bombas de achique – Servicios pesados.
- FR** Interrupteur automatique pour pompes vide de cale – Services lourds.
- PT** Interruptor automático para bombas de porão – Serviços pesados.

CODICE PART NUMBER	AMP. max.	OFF/ON	CAVO WIRE	DIMENSIONI DIMENSIONS mm
161 003 10	20 (12V) - 10 (24V)	19/51 mm	900 mm	127 x 42 x 110

IMP1



CODICE PART NUMBER	MATERIALE MATERIAL	RICAMBIO ORIGINALE PER ORIGINAL SPARE PART FOR	DIMENSIONI DIMENSIONS mm	FORO BORE mm
163 000 00	Gomma nitrilica Nitrile rubber	UP1 - UP1/N - UP1/M - UP1/AC	Ø 51,5 x 22	8

IMP2



CODICE PART NUMBER	MATERIALE MATERIAL	RICAMBIO ORIGINALE PER ORIGINAL SPARE PART FOR	DIMENSIONI DIMENSIONS mm	FORO BORE mm
163 001 00	Gomma nitrilica Nitrile rubber	UP1/J	Ø 40,5 x 22	8

IMP2/V



CODICE PART NUMBER	MATERIALE MATERIAL	RICAMBIO ORIGINALE PER ORIGINAL SPARE PART FOR	DIMENSIONI DIMENSIONS mm	FORO BORE mm
163 002 00	FKM	UP1/J	Ø 40,5 x 22	8

RJ11



CODICE PART NUMBER	DESCRIZIONE DESCRIPTION	LUNGHEZZA CAVO CABLE LENGTH m
165 410 00	Cavo nero con accoppiatore per SCS / PCS Black cable with coupler for SCS / PCS	10
165 411 00	Cavo nero con accoppiatore per SCS / PCS Black cable with coupler for SCS / PCS	3

ATX1



0,5liters

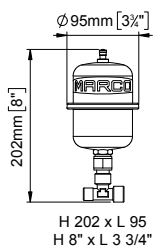

ATX2



2 liters

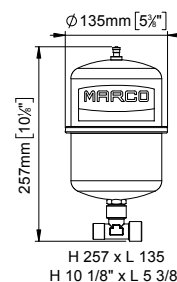

IT Vasi ad espansione in acciaio inox per pompe automatiche. Attacco in acciaio inox. Membrana in gomma per liquidi alimentari.

DE Ausdehnungsgefäße aus Edelstahl für automatische Pumpen. Verbindungsstück aus Edelstahl. Membran aus Gummi zur Benutzung von flüssigen Lebensmitteln.

FR Vases d'expansion en acier inoxydable pour pompes automatiques. Connexion en acier inoxydable. Membrane en caoutchouc pour liquides alimentaires.

EN Stainless steel accumulator tanks for automatic pumps. Stainless steel port. Rubber membrane suitable for foodstuffs.

ES Acumuladores de presión en acero inox para bombas automáticas. Conexión en acero inox. Membrana en goma para líquidos alimenticios.

PT Acumuladores de pressão em aço inox para bombas automáticas. Ligação em aço inox. Membrana em borracha para líquidos alimentares.

TIPO TYPE	CODICE PART NUMBER	FINITURA FINISHING	CAPACITÀ CAPACITY litri / liters	PRESSIONE PRESSURE std max	DIMENSIONI DIMENSIONS	BOCCA CONNECT
ATX1	165 080 10	acciaio inox stainless steel	0,5	1 bar 14.5 psi	10 bar 145 psi	Ø95x202 3/8" BPS
ATX1	165 080 11	acciaio inox stainless steel	0,5	1 bar 14.5 psi	10 bar 145 psi	Ø95x202 1/2" BPS
ATX2	165 081 10	acciaio inox stainless steel	2	1 bar 14.5 psi	10 bar 145 psi	Ø135x257 1/2" BPS

AT1



2 liters

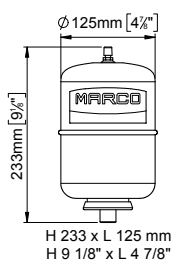

AT2



5 liters

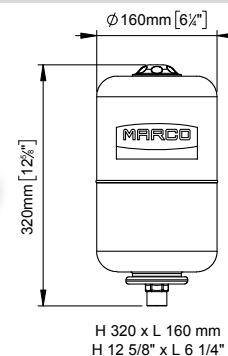

IT Vasi ad espansione per pompe automatiche, verniciati bianchi. Attacco in acciaio inox. Membrana in gomma per liquidi alimentari.

DE Ausdehnungsgefäße für automatische Pumpen, weiß-lackiert. Verbindungsstück aus Edelstahl. Membran aus Gummi zur Benutzung von flüssigen Lebensmitteln.

FR Vases d'expansion pour pompes automatiques, vernissés blancs. Connexion en acier inoxydable. Membrane en caoutchouc pour liquides alimentaires.

EN Accumulator tanks for automatic pumps, white-painted. Stainless steel port. Rubber membrane suitable for foodstuffs.

ES Acumuladores de presión para bombas automáticas, barnizados blancos. Conexión en acero inox. Membrana en goma para líquidos alimenticios.

PT Acumuladores de pressão para bombas automáticas, pintados em branco. Ligação em aço inox. Membrana em borracha para líquidos alimentares.

TIPO TYPE	CODICE PART NUMBER	FINITURA FINISHING	CAPACITÀ CAPACITY litri / liters	PRESSIONE PRESSURE std max	DIMENSIONI DIMENSIONS	BOCCA CONNECT
AT1	165 082 10	verniciato bianco white painted	2	1,3 bar 18.9 psi	10 bar 145 psi	Ø125x233 1/2" BPS
AT2	165 083 10	verniciato bianco white painted	5	1,3 bar 18.9 psi	8 bar 116 psi	Ø160x320 3/4" BPS

DHK1



Heavy duty

IT Kit tubo per pompa lavaggio ponte estensibile fino a 15 m, pistola e connessione da 3/4". Raccordi e connessione in ottone nichelato compatibile con DQC.

DE Ausziehbarer Schlauch für Deckwaschpumpe, erweiterbar bis 15m, Spritzpistole, 3/4" Anschluss. Rohrverbindungsstück und Schnellverbindung aus vernickeltem Messing, kompatibel mit DQC.

FR Kit de tuyau pour pompe à laver, tuyau rétractable de 15 m, pistolet, raccord 3/4". Raccords et connexion rapide en laiton nickelé compatible avec DQC.

EN Deck hose kit with 15m/50ft retractable hose, spray gun, 3/4" connection. Nickel plated brass fittings and quick connection suitable for DQC.

ES Kit de tubo para bomba de cubierta, con tubo retráctil de 15 m, pistola, conexión de 3/4". Rcores y conexión rápida en latón niquelado compatible con DQC.

PT Kit de tubo para bomba de lavagem com tubo retrátil de 15 m, pistola, conexão de 3/4". Ligações e conexão rápida em latão niquelado compatível com DQC.

TIPO TYPE	CODICE PART NUMBER	DESCRIZIONE DESCRIPTION	RACCORDI FITTINGS
DHK1	165 101 00	Tubo estensibile fino a 15 m, pistola e connessione rapida 15 m/50 ft retractable hose, spray gun, quick connection	3/4" BSPP

DQC



Heavy duty

IT Connessione rapida a scatto per pompe di lavaggio DP. Estremamente semplice da installare. Compatibile con tubo DHK1.

DE Schnellverbindung mit Klick für Deckwaschpumpe. Äußerst einfach zu montieren. Kompatibel mit Schlauch DHK1.

FR Connexion rapide à déclenchement pour pompes de lavage DP. Très facile à installer. Compatible avec tuyau DHK1.

EN Quick-click connection for DP washing pumps. Very easy to install. Suitable for DHK1 hose.

ES Conexión rápida a presión para bombas de lavado DP. Muy fácil de instalar. Compatible con tubo DHK1.

PT Ligação rápida de encaixe para bombas de lavagem. Muito fácil de instalar. Compatível com tubo DHK1.

TIPO TYPE	CODICE PART NUMBER	DIMENSIONI DIMENSIONS mm	CONNESSIONI CONNECTION	FORO HOLE
DQC	165 100 00	90x84x55	int. Ø 12.5 ÷ 15,5	Ø78

IS14 IS16



IT Filtro in linea in nylon trasparente con parte filtrante in acciaio inox AISI 304. Chiusura a scatto per una facile ispezione e pulizia.

DE Angeschlossener Filter aus durchsichtigem Nylon mit Filternetz aus Edelstahl AISI 304. Druckverschluss für eine einfache Reinigung.

FR Filtre en ligne de nylon transparent avec grille filtrante en acier inoxydable AISI 304. Déclenchement rapide pour faciliter l'inspection et le nettoyage.

EN In-line filter made of transparent nylon with AISI 304 stainless steel net. Snap-on locking for easy inspection and cleaning.

ES Filtro en línea de nylon transparente con rejilla de acero inoxidable AISI 304. Gran facilidad de desmontaje para su limpieza.

PT Filtro em linha de nylon transparente com rede de aço inoxidável AISI 304. Grande facilidade de desmontagem para a limpeza.

TIPO TYPE	CODICE PART NUMBER	RACCORDI CONNECTIONS	TUBO TUBE	MATERIALE MATERIAL	O-RING	GRIGLIA NET
IS14	165 000 10	3/8" BSP	Ø14 mm interno Ø14 mm inner tubing	PA6	NBR	0,5x0,5
IS14	165 002 10	3/8" BSP	Ø14 mm interno Ø14 mm inner tubing	PA6	FKM	0,5x0,5
IS14	165 003 10	3/8" BSP	Ø14 mm interno Ø14 mm inner tubing	PA6	SILICONE	0,5x0,5
IS16	165 001 10	1/2" BSP	Ø16 mm interno Ø16 mm inner tubing	PA6	NBR	0,5x0,5
IS20	165 004 10	3/4" BSP	Ø20 mm interno Ø20 mm inner tubing	PA6	NBR	0,5x0,5

OK1



Part No. 165 020 00

IT Kit tubi Ø 8 mm e 6 mm esterno per pompe travaso olio.

EN Tube kit of 8 mm and 6 mm ext. Ø for oil pumps.

DE Schlauchkit Ø 8 mm und 6 mm für Ölpumpen.

ES Kit tubos Ø 8 mm y 6 mm ext. para bombas de transvase aceites.

FR Kit de tuyaux Ø 8 mm et 6 mm ext. pour transvasement d'huiles.

PT Kit de tubos Ø 8 mm y 6 mm ext. para bombas de trasfega óleos.

OCP1/3

3/8" valve



OCP2/3

Two 3/8" valves



OCP1/6

1/2" valve



OCP2/6

Two 1/2" valves



TIPO
TYPE

CODICE
PART NUMBER

DESCRIZIONE
DESCRIPTION

BOCCHIE
PORTS

OCP1/3	165 030 00	1 valve tap for UP3-RK	3/8" BSPP
OCP2/3	165 031 00	2 valves tap for UP3-RK	3/8" BSPP
OCP1/6	165 032 00	1 valve tap for UP6-RK	1/2" BSPP
OCP2/6	165 033 00	2 valves tap for UP6-RK	1/2" BSPP

KB



IT Kit cavi e pinze per batteria.

EN Kit of cables and battery clips.

DE Kabelkit mit Batterieklemmen.

ES Kit de cables y clips de batería.

FR Kit de câbles et pinces de batterie.

PT Kit de cabos e pinças de alimentação.

CODICE
PART NUMBER

AMP.
max.

CONNETTORE
CONNECTOR

LUNGHEZZA CAVO
CABLE LENGTH
mm

165 400 00	15	Faston 6.3 x 0.8	3000
------------	----	------------------	------

BF20

BF25



IT Filtro di fondo e portagomma per tubo Ø20 o Ø25 mm.

EN Bottom filter and hosefittings for tubing Ø20 mm or Ø 25 mm.

DE Fußfilter und Schlaucholive für Ø20 mm oder Ø25 mm Schlauch.

ES Filtro de fondo y conexiones para tubo Ø20 o Ø25 mm.

FR Filtre de fond et connexions pour tuyau de Ø20 ou Ø25 mm.

PT Filtro de fundo e ligações para tubo de Ø20 ou Ø25 mm.

CODICE
PART NUMBER

TUBO
HOSE
Ø mm

O-RING

RETE
MESH
mm

MATERIALE
MATERIAL

165 005 10	20	3087 NBR	0,6	PA6 & PPL
165 006 10	25	3087 NBR	0,6	PA6 & PPL

RADIO CONTROLLED SEARCH LIGHTS

FM2



▪ High resistance polycarbonate light cover

Features

- Operating temperature: -30°C +50°C
- 360° horizontal movement
- 260° vertical movement
- Automatic position resetting
- Beam depth: 350 m

CODICE PART NUMBER	VOLT	LAMPADA BULB	AMP.	PROTEZIONE PROTECTION	Cd (p)	DIMENSIONI DIMENSIONS mm
170 020 12	12	H1 100W	7,5	IP55	130.000	Ø135xh250
170 020 13	24	H1 100W	3,8	IP55	130.000	Ø135xh250

FM3



▪ High resistance polycarbonate light cover

Features

- Operating temperature: -30°C +50°C
- 360° horizontal movement
- 260° vertical movement
- Automatic position resetting
- Beam depth: 350 m

CODICE PART NUMBER	VOLT	LAMPADA BULB	AMP.	PROTEZIONE PROTECTION	Cd (p)	DIMENSIONI DIMENSIONS mm
170 040 12	12	H1 100W	7,5	IP55	130.000	Ø165xh194
170 040 13	24	H1 100W	3,8	IP55	130.000	Ø165xh194

SOLENOID VALVES

EV-M312



▪ Fuel cut-off solenoid valves

Features

- RINA Regulation compliant
- For inboard engines
- Safety knob for manual opening

CODICE PART NUMBER	VOLT	AMP.	PASSAGGIO HOLE Ø mm	BOCCHIE PORTS	RACCORDI CONNECTIONS Ø mm	BAR max.	PORTATA FLOW RATE max.
140 040 12	12	1	12	1/2"	12	3	69 l/min
140 040 13	24	0,55	12	1/2"	12	3	69 l/min

EV-MA



▪ Fresh water solenoid valves

Features

- Main applications:
 - Wiper systems
 - Anchor chain washing
 - Water distribution on board

CODICE PART NUMBER	VOLT	AMP.	PASSAGGIO HOLE Ø mm	BOCCHIE PORTS	BAR max.	PORTATA FLOW RATE max.
140 200 12	12	1	4,5	1/4"	5	21 l/min
140 200 13	24	0,55	4,5	1/4"	5	21 l/min

SPONSORSHIP



Kristian Ghedina

MARCO is main sponsor of the UIM OFFSHORE Class 3D World Championship



Rodi Garganico
Italy



Tvedestrand
Norway

www.venetamarina.com

MARCO[®]

COMPANY CERTIFICATIONS



ISO 9001

In più di cinquant'anni di attività produttiva abbiamo sempre perseguito e mantenuto l'obiettivo qualità. Siamo determinati a costruire qualità dentro ogni cosa che facciamo. Vogliamo dare performance sempre migliori nei giusti tempi. Con una costante attenzione ai bisogni delle persone del nostro settore e coinvolgendo i nostri operatori in un'azione motivata e partecipe proponiamo prodotti, soluzioni e servizi innovativi mirando a superare le loro stesse aspettative. La nostra strategia aziendale si sviluppa attraverso un processo informativo sempre più controllato. Il nostro compito è quello di essere un partner affidabile per i nostri interlocutori, contribuire sempre più al loro successo attraverso la nostra organizzazione. La loro fiducia costituisce il nostro motivo ed è allo stesso tempo obiettivo di esistenza nel mercato internazionale.

In mehr als 50 Jahren langen Aktivität haben wir die Qualität immer an die erste Stelle gesetzt. Wir sind entschlossen, diese Qualität in alle Teile zu integrieren, die wir entwickeln und herstellen. Wir streben danach, unser Leistungsvermögen innerhalb angemessener Zeitparameter ständig zu verbessern. Wir möchten innovative Produkte, Lösungen und Dienstleistungen anbieten, unter Berücksichtigung der Anforderungen und Bedürfnisse unserer Kunden, gepaart mit einem koordinierten und motivierten Handeln unserer Mitarbeiter, um die Kundenerwartungen zu übertreffen. Unsere Firmenstrategie entwickelt sich mit den digitalisierten und ständig besser kontrollierten Informations- und Produktionstechnologien. Unser Anliegen ist es, all unseren Kunden ein verlässlicher Partner zu sein und durch unsere Organisation zu deren Erfolg beizutragen. Das Vertrauen unserer Kunden ist unsere Antriebskraft und zugleich unser Ziel, um auf dem internationalen Markt zu bestehen.

En plus de cinquante ans nous avons toujours poursuivi et maintenu l'objectif qualité. Nous sommes déterminés à construire qualité à l'intérieur de toute chose que nous faisons. Nous voulons donner performances de plus en plus meilleures dans les plus justes temps. Avec une constante attention aux besoins des personnes de notre secteur et impliquant nos opérateurs dans une action motivée et participée, nous proposons des produits, des solutions, et des services innovants en visant à surpasser leurs mêmes attentes. La stratégie de notre Maison se développe par un processus informatif de plus en plus contrôlé. Notre rôle est celui d'être un partenaire efficace et fidèle pour tous nos interlocuteurs et contribuer de plus en plus à leur succès à travers notre organisation. Leur confiance constitue notre but et en même temps l'objectif d'existence dans le marché international.

We have constantly strived for, and maintained the quality objective in more than fifty years of our manufacturing activity. We are determined to build quality into everything we make. We wish to constantly improve performance within adequate time parameters. Keeping in mind the needs of those who operate in our market sector, together with a coordinated and motivated action plan involving all our partners, we wish to offer innovative products, solutions and services while at the same time striving to exceed their expectations. Our company strategy is to evolve through a well controlled and informed business process. We aim to be a reliable partner to all our customers and to contribute increasingly to their success through our organization. Their trust constitutes our motive and at the same time our objective for existence in the international market.

En más de cincuenta años de actividad productiva hemos siempre perseguido y mantenido el objetivo calidad y estamos aún más decididos en "construir" calidad en cualquier cosa que vamos hacer. Queremos dar prestaciones siempre mejores en los tiempos adecuados. Con una atención constante a las necesidades de las personas de nuestro sector y envolviendo nuestros operadores en una acción motivada y participada, proponemos productos, soluciones y servicios innovadores, aspirando a superar sus mismas expectativas. Nuestra estrategia empresarial se desarrolla por medio de un proceso informativo muy avanzado y controlado. Nos proponemos ser un partner fiable para nuestros interlocutores y contribuir siempre más a su éxito por medio de nuestra organización. Su confianza constituye nuestro motivo y al mismo tiempo objetivo de existencia en el mercado internacional.

Em mais de cinquenta anos de actividade produtiva sempre seguimos e mantivemos o objectivo da qualidade e estamos cada vez mais decididos a "construir" qualidade em qualquer coisa que fazemos. Queremos dar sempre a melhor performance na hora certa. Com uma atenção constante nas necessidades das pessoas no nosso sector, e envolvendo os nossos colaboradores numa acção motivada e participante, propomos produtos, soluções e serviços inovadores, aspirando ultrapassar as suas expectativas. A nossa estratégia empresarial desenvolve-se por meio dum processo informativo muito avançado e controlado. Ambicionamos ser um parceiro fiável para nossos interlocutores e contribuir cada vez mais para o seu êxito por intermédio da nossa organização. A sua confiança constitui o nosso motivo e ao mesmo tempo o objetivo da nossa existência no mercado internacional.



ISO 14001

Alla base della vita c'è il rispetto di essa. Trattare le risorse della natura con responsabilità è diventato un motivo dominante per chi, come noi, vuole offrire un futuro all'ambiente. La qualità della vita di tutti i giorni è il presupposto per l'esistenza di un futuro affrontabile. Materiali riciclabili, prodotti a ridotto consumo di energia, procedimenti produttivi ecologici, operatori formati e informati contribuiscono a salvaguardare passo dopo passo l'ambiente come risultato di una scelta attenta e consapevole.

Ausgangspunkt des Lebens ist der Respekt für dasselbe. Die natürlichen Ressourcen müssen verantwortungsbewußt benutzt werden; das ist das Leitmotiv für all diejenigen, die, wie wir, der Umwelt eine Zukunft bieten wollen. Die Qualität das Alltags ist die Voraussetzung für eine akzeptable Zukunft. Material zur Wiederverwertung, Produkte, die ein Minimum an Energie verbrauchen, ökologische Produktionsverfahren, sowie ausgebildetes und höchstinformiertes Personal tragen dazu bei, Schritt für Schritt die Umwelt zu respektieren und sie mit verantwortungsbewußten Entscheidungen zu retten.

À la base de la vie il y a le respect. Traiter les ressources de la nature avec responsabilité est devenu un motif dominant pour qui, comme nous, veut offrir un futur à l'environnement. La qualité de la vie de tous les jours est le fondement de l'existence d'un futur abordable. Matériels recyclés, produits à consommation d'énergie réduite, procédés de production écologiques, opérateurs formés et informés contribuent, pas à pas, à sauvegarder l'environnement comme résultat d'un choix de conscience.

Respect for life remains at the essence of life itself. Managing nature's resources with responsibility has become a dominant motive for those who, like us, wish to contribute to the future of the environment. Everyday quality of life is a basic requirement for the existence of a promising future. Recyclable materials, reduced energy consumption products, ecological production processes, well-trained and informed workers, all contribute to protecting the environment, step by step, as a result of responsible and accurate choices made all along.

El respeto a la vida es la esencia de la vida misma. Tratar los recursos de la naturaleza con cuidado se ha hecho un motivo dominante para quien, como nosotros, quiere garantizar un futuro al ambiente. La calidad de la vida cotidiana es la premisa para la existencia de un futuro posible. Materiales reciclables, productos a bajo consumo de energía, procesos productivos ecológicos, operadores formados e informados contribuyen a salvaguardar paso a paso el medio ambiente como logro de una elección atenta y consciente.

O respeito pela vida é a essência da própria vida. Tratar os recursos da natureza com responsabilidade tornou-se num motivo dominante para quem, como nós, quer garantir um futuro ao ambiente. A qualidade da vida diária é a premissa para a existência dum futuro promissor. Materiais recicláveis, produtos de baixo consumo de energia, processos produtivos ecológicos, operadores formados e informados contribuem para salvaguardar passo a passo o meio ambiente, como resultado duma escolha atenta e consciente.

Garanzia

- 1) Il periodo di garanzia è di 2 anni dalla data d'acquisto come risulta dalla relativa fattura.
- 2) Nel caso la fattura non fosse disponibile, il periodo di garanzia di 2 anni sarà calcolato dalla data di fabbricazione.
- 3) La garanzia decade e s'intende nulla in caso d'utilizzazione non corretta o nel caso venissero ignorate le istruzioni contenute nei manuali.
- 4) La garanzia copre solamente i difetti di fabbricazione.
- 5) La garanzia non copre i costi connessi di installazione e smontaggio.
- 6) I costi di trasporto sono rimborsabili solo nel caso in cui la garanzia sia stata debitamente riconosciuta e accettata da Marco S.p.A. Il rimborso sarà limitato ai costi di spedizione dal magazzino di Marco S.p.A. alla sede del cliente.
- 7) Nessuna nota di credito o reso saranno effettuati prima di un test eseguito dal controllo di qualità di Marco S.p.A. che dichiari difettoso il prodotto.

La società MARCO non accetterà nessun reso senza previa accettazione e accordo dell'ufficio commerciale.

Garantie

- 1) Die Garantie von 2 Jahren beginnt mit dem Einkaufsdatum d.h. Datum unserer Rechnung an den Kunden.
- 2) Für den Fall, dass die Rechnung nicht vorliegt beginnt die Garantie von 2 Jahren ab unserem Produktionsdatum.
- 3) Die Garantie verfällt bei nicht korrektem Einsatz des Produktes, oder bei Ignorierung der Gebrauchsanweisungen.
- 4) Die Garantie wird nur für Produktionsfehler akzeptiert
- 5) Die Garantie beinhaltet nicht die Kosten für Installation oder Abmontierungen
- 6) Die Transportkosten werden von der Firma MARCO S.p.A. nur in dem Fall getragen, wo der Garantiefall akzeptiert wurde. Diese Kosten beinhalten den Transport ab dem Werk der Firma MARCO bis zum Firmensitz des Kunden.
- 7) Es wird keine Gutschrift erstellt und kein Austausch gestattet bis die erfolgten Tests der Qualitätskontrolle von der MARCO S.p.A. einen effektiven Produktionsfehler bewiesen haben.

Die Firma MARCO akzeptiert keine Rücksendungen ohne vorherige Absprache mit dem Verkaufsbüro.

Garantie

- 1) La période de garantie est de 2 ans de la date d'achat qui est indiquée sur la facture correspondante.
- 2) Le cas où la facture ne soit pas disponible la période de garantie de 2 ans sera calculée de la date de fabrication.
- 3) La garantie déchoit et est considérée annulée en cas d'utilisation incorrecte ou en cas les instructions contenues dans le manuel d'instructions soient ignorées.
- 4) La garantie couvre seulement les défauts de fabrication.
- 5) La garantie ne couvre pas les coûts liés à l'installation et démontage.
- 6) Les frais de transport sont remboursables seulement le cas où la garantie est dument reconnue et acceptée par MARCO S.p.A. Ces coûts seront limités aux frais d'expédition entre le magasin de Marco S.p.A. et l'adresse du client.
- 7) Aucune note de crédit ou de remplacement sera émise avant que le produit réclamé soit examiné par le Département de Contrôle de Qualité de MARCO S.p.A. qui est le seul qui peut déclarer défectueux le produit.

La maison MARCO n'acceptera pas aucun retour de marchandise sans préalable accord et acceptation du bureau commerciale.

Warranty

- 1) The Warranty period is 2 years from date of purchase on production of the appropriate sales invoice.
- 2) Should the original sales invoice not be available, then the 2 year warranty period will be valid from date of production.
- 3) The Warranty becomes null and void in the case of incorrect utilization or disregard of the instructions contained within manuals.
- 4) The Warranty only covers original production defects.
- 5) The Warranty does not cover any related installation costs involved.
- 6) Transport costs are refundable only in the case where warranty has been duly recognized and accepted by Marco Spa. These costs will be limited to the actual shipment costs between Marco Spa warehouse and the client's delivery address.
- 7) No credit notes or replacement items will be issued prior to the receipt and proper testing of any Marco goods that are deemed faulty.

The company MARCO will not accept any returned goods without prior agreement and approval of the sales department.

Garantía

- 1) El periodo de garantía es de 2 años de la fecha de compra, como resulta en la factura relativa.
- 2) En el caso que la factura no sea disponible, el periodo de garantía de 2 años será calculado de la fecha de producción.
- 3) La garantía vence y se considera nula en caso de uso incorrecto o en caso sean desatendidas las instrucciones contenidas en los manuales.
- 4) La garantía cubre solamente los defectos de fabricación.
- 5) La garantía no cubre los costes envueltos de instalación y desmontaje.
- 6) Los costes de transporte son reembolsables sólo en el caso que la garantía haya sido reconocida y aceptada por Marco S.p.A. Estos costes serán limitados a los costes de envío desde el almacén de Marco S.p.A. y la sede del cliente.
- 7) Ninguna nota de crédito o devolución será hecha antes de un test realizado por el control de calidad de Marco S.p.A que declare el producto defectuoso.

La firma MARCO no podrá aceptar devoluciones de mercadería sin previo acuerdo y aprobación del departamento comercial.

Garantia

- 1) O período de garantia é de 2 anos da data de compra, como indicado na factura relativa.
- 2) Caso a factura não esteja disponível, o período de garantia de 2 anos será calculado a partir da data de fabrico.
- 3) A garantia caduca e é considerada nula no caso de incorrecta utilização ou no caso em que sejam ignoradas as instruções contidas nos manuais.
- 4) A garantia cobre só os defeitos de fabricação.
- 5) A garantia não cobre custos de instalação e/ou desmontagem.
- 6) Os custos de transporte são reembolsáveis só no caso em que a garantia seja reconhecida e aceite pela Marco S.p.A. O reembolso será limitado aos custos de envio desde o armazém da Marco S.p.A. até à sede do cliente.
- 7) Nenhuma nota de crédito ou devolução será feita antes dum teste efectuado pelo controle de qualidade da Marco S.p.A, que declare o produto defeituoso.

A firma MARCO não poderá aceitar devoluções de mercadoria sem prévio acordo e aprovação pelo departamento comercial.

RETURN PROCEDURE

PROCEDURA RESI

Prima di restituire un prodotto alla MARCO s.p.a. contattare l'assistenza clienti per ricevere un numero di autorizzazione. Questo numero va riportato sull'esterno del pacco di spedizione. Inserire nel pacco una nota con la spiegazione del motivo della restituzione e indicare anche il numero di autorizzazione, il vostro nome, indirizzo e numero di telefono.

RÜCKGABEVERFAHREN

Vor jeder Rücksendung eines Produktes an Marco s.p.a. bitten wir Sie uns anzurufen, damit wir Ihnen eine genehmigte Vorgangsnummer zuteilen. Diese Vorgangsnummer muss auf der Außenseite des Versand-Pakets lesbar sein. Legen Sie eine Fehlerbeschreibung in das Paket mit einer erneuten Nennung der Vorgangsnummer. Fügen Sie Ihren Namen, Anschrift und Telefonnummer bei.

PROCÉDURE DE RETOUR

Avant de renvoyer un produit à la maison MARCO S.P.A. il faut contacter notre service d'assistance aux clients pour avoir le numéro d'autorisation au retour. Ce numéro devra être mentionné à l'extérieur du colis d'expédition. En même temps insérer dans le colis une note expliquant la raison du retour et indiquant le numéro d'autorisation, Votre nom, adresse et numéro de téléphone.

RETURN PROCEDURE

Prior to returning any product to MARCO s.p.a. call customer service for an authorization number. This number must be written on the outside of the shipping package. Place a note inside the package explaining the reason of the return and reporting the authorization number. Include your name, address and phone number.

PROCEDURA DE DEVOLUCIONES

Antes de devolver un producto a la MARCO s.p.a., contactar el servicio clientes para recibir un número de autorización. Este número tiene que ser escrito al exterior del paquete de expedición. Insertar en el paquete una nota con la explicación del motivo de la devolución, indicando también el número de autorización, su nombre, dirección y número de teléfono.

PROCESSO DE DEVOLUÇÕES

Antes de devolver um produto à MARCO s.p.a., contactar o serviço clientes para receber um número de autorização. Este número tem que ser escrito no exterior do pacote de expedição. Inserir no pacote uma nota com a explicação do motivo da devolução, indicando também o número de autorização, seu nome, endereço e número de telefone.



MATE USA was developed thanks to the partnership between **Marco** and **Tessilmare**, two of the world leading high quality Italian manufacturers.

Marco produces and sells one of the most comprehensive ranges of pumps and horns available worldwide. Founded in Italy in 1970, they supply major international OEM and aftermarket players in the marine, automotive, industrial and agricultural sectors using the most advanced technology and complying with the highest International Quality Standards.

Tessilmare is renowned for providing some of the most affordable, durable, and attractive ranges of rub rails anywhere in the world. Founded in Italy in 1947, you know you're getting a high-quality product, with a precision finish.

The international experience of both Italian companies is the base on which MATE USA built their ambitious distribution plan.

Through market research and global innovation, MATE USA is constantly growing and expanding to meet global demand.

MATE USA understands what it takes to be successful in a high-speed, online, global marketplace.

The company has been providing top of the line, affordable and durable products throughout the United States for almost 10 years.

As part of its ongoing commitment to excellence and product innovation, MATE USA has constantly been striving to upgrade its services and products. MATE USA has an ever-increasing number of partners and distributors across North America. They are also attending over 25 trade shows and exhibition shows this year.

MATE USA is structured for daily deliveries.

That means that when you order your products from MATE USA, they'll be on their way to you within 24-hours!



MATE USA, LLC

3251-A S.W. 13th Dr. - Deerfield Beach, FL 33442

Phone 954-463-5757 • Fax 954-463-5635

www.mate-usa.com

info@mate-usa.com

orders@mate-usa.com

Tipo Type	12V	24V	Aria Air	Electroniche Electronic	Manuali Hand Horn	Pressione Acustica Sound Pressure Level	Finitura Cromata Chromed Finishing	Finitura Bianca White Finishing	Acciaio Inox Lucido Bright Stainless Steel	Ottone Brass	Plastica Plastic	IMO 12<->20m	IMO 20<->75m	Imbarcazioni <50m conf. D.M. 421/90	Imbarcazioni <12m	Pagina Page
PW2	●	●	●			123		●		●	●					7
PW2-BC	●	●	●			123	●			●	●					7
PW2-BB	●	●	●			123		●		●	●					7
PW3	●	●	●			132		●		●		●				8
PW3-BC	●	●	●			132	●			●			●			8
PW3-BB	●	●	●			132		●		●			●			8
EW2	●	●		●		122		●			●	●				10
EW2-M	●	●		●		122		●			●	●				10
EW2-MS	●	●		●		122		●			●	●				10
EW3		●		●		131		●			●		●			11
EW3-M		●		●		131		●			●		●			11
EW3-MS		●		●		131		●			●		●			11
BE2					●					●		●				12
BE2-C					●		●			●		●				12
BE3					●					●			●			12
BE3-C					●		●			●			●			12
EMH	●	●		●		112		●			●				●	13
EMH-M	●	●		●		112		●			●				●	14
EMH-MS	●	●		●		112		●			●				●	14
EMH-2	●	●		●		115		●			●				●	14
TA1			●		●	122					●					17
TA1B			●		●	-					●					17
TA1-H			●		●	122					●					17
TA1B-H			●		●	-					●					17
TA1R			●		●	122					●		●			18
TA1X			●		●	122					●				●	18
MT1-H	●	●				114	●				●				●	20
MT1-L	●	●				114	●				●				●	20
MT2	●	●				116	●				●				●	20
EM1	●	●				118			●						●	20
EM2	●	●				118			●						●	21
EM1/2	●	●				121			●						●	21
EMX1	●	●				119			●						●	21
EMX2	●	●				119			●						●	21
EMX1/2	●	●				122			●						●	22
DUK	●					114			●						●	22
TCE	●	●				114		●		●					●	22
BK1	6÷100		●			85/95					●					22
BK2	9÷28		●			105					●					22
SK1	●					108		●			●				●	23
SK1/C	●					108	●				●				●	23
SM1	●					108		●			●				●	23
SM1/C	●					108	●				●				●	23
SM1/B	●					108					●				●	23
HR1	●	●	●			120		●			●				●	25
HR1/C	●	●	●			120	●				●				●	25
MA1-C	●	●	●			114	●				●				●	25
MA1-S	●	●	●			117	●		●						●	25
RIM-N	●	●	●			111	●			●					●	26
TT2-M	●	●	●			111	●				●				●	26
TC1/P	●	●	●			116		●			●				●	26

dB (1/3 OCT.) 1m
dBA 1m

Tipo Type	12V	24V	230V	Portata l/min Flow Rate l/min	Pressione bar Pressure bar	Diesel	Olio Oil	Acqua e Soluzioni Water and Fluids	Alta Pressione High Pressure	Elettroniche Electronic	Controllo Remoto Remote Control	Reversibile Reversible	Kit	Pagina Page
UP2/E	●	●		10	2			●		●				31
UP3/E	●	●		15	2,5			●		●	●			31
UP6/E	●	●		26	2,5			●		●	●			31
UP6/E H.P.		●		26	3,5			●	●	●	●			31
UP12/E	●	●		36	2,5			●		●	●			32
UP12/E H.P.		●		36	3,5			●	●	●	●			32
UP12/E-LO	●	●		26	3			●		●	●			32
UP14/E	●	●		46	2,5			●		●	●			32
UP14/E H.P.		●		46	3,5			●	●	●	●			32
UP6/E-DX	●	●		52	2,5			●		●	●			33
UP6/E-DX H.P.		●		52	3,5			●	●	●	●			33
UP66/E-DX	●	●		66	2,5			●		●	●			33
UP66/E-DX H.P.		●		66	3,5			●	●	●	●			33
UP12/E-DX	●	●		72	2,5			●		●	●			33
UP12/E-DX H.P.		●		72	3,5			●	●	●	●			33
UP14/E-DX	●	●		92	2,5			●		●	●			34
UP8/E	●	●		10	3,5			●	●	●	●			34
UP9/E	●	●		12	4,5			●	●	●	●			34
UP10/E	●	●		18	6			●	●	●	●			35
SP2	●	●		10	2			●		●		●		35
TK1/2	●	●		10	2			●		●		●		35
TK2/2	●	●		10	2			●		●		●		35
DP3/E	●	●		14	3			●		●		●		36
DP9/E	●	●		12	4,5			●	●	●		●		36
DP12/E	●	●		15	5			●	●	●		●		36
UP2-P	●	●		10	1,5			●			●			40
UP2-PV	●	●		10	1,5			●						40
UP3-P	●	●		15	2			●			●			40
UP3-PV	●	●		15	2			●						41
UP6-P	●	●		26	2			●			●			41
UP6-PV	●	●		26	2			●						41
UP12-P	●	●		36	2			●			●			42
UP12-PV	●	●		36	2			●						42
UP14-P	●	●		46	2			●			●			42
UP14-PV	●	●		46	2			●						43
UP8-P	●	●		10	4			●	●		●			43
UP9-P	●	●		12	4			●	●		●			43
UP10-P	●	●		18	7			●	●		●			44
UP1-J	●	●		28	1			●			●			46
UP1-JS	●	●		28	1			●			●			46
UP1-JR	●	●		28	1			●			●			46
UP1	●	●		35	1,2			●			●			47
UP1-M	●	●		45	1,5			●			●			47
UP1-B	●	●		45	1,5			●			●			47
UP1/AC			●	30	1			●						48
UP500	●	●		32	0,4			●						50
UP1000	●	●		63	0,4			●						50
UP1500	●	●		95	0,4			●						50
UP2000	●	●		126	0,5			●						51
UP3700	●	●		233	0,5			●						51
UP2	●	●		10	1,5	●					●			53
UP3	●	●		15	2	●					●			53
UP3-CK	●	●		15	2	●					●	●		53
UP3-S	●	●		15	2	●					●			54
UP3-R	●	●		15	2	●					●			54
UP6	●	●		26	2	●					●			54
UP12	●	●		36	2	●					●			55
UP14	●	●		46	2	●					●			55
UP8	●	●		10	4	●			●		●			55

Model	12V	24V	230V	Portata l/min Flow Rate l/min	Pressione bar Pressure bar	Diesel	Olio Oil	Acqua e Soluzioni Water and Fluids	Alta Pressione High Pressure	Elettroniche Electronic	Controllo Remoto Remote Control	Reversibile Reversible	Kit	Pagina Page
UP9	●	●		12	4	●			●			●		56
UP10	●	●		18	7	●			●			●		56
UP3/AC			●	10	6	●			●					56
UP6/AC			●	28	5	●			●					57
UP14/AC			●	44	4	●			●					57
VP45-N	●	●		45	1,2	●								59
VP45	●	●		45	1,2	●						●		59
VP45-S	●	●		45	1,2	●								59
VP45A-S	●	●		45	1,2	●								60
VP45-K	●	●		45	1,2	●							●	60
VP45/AC			●	35	1	●								60
UP2/E-BR	●	●		10	2	●	●			●	●			62
UP3/E-BR	●	●		15	2,5	●	●			●	●			62
UP6/E-BR	●	●		26	2,5	●	●			●	●			62
UP12/E-LOBR	●	●		26	3	●	●			●	●			63
UP12/E-BR	●	●		36	2,5	●	●			●	●			63
UP14/E-BR	●	●		46	2,5	●	●			●	●			63
UP8/E-BR	●	●		10	3,5	●	●		●	●	●			64
UP9/E-BR	●	●		12	4,5	●	●		●	●	●			64
UP10/E-BR	●	●		18	6	●	●		●	●	●			64
UP8-RE	●	●		10	3,5	●	●		●	●		●		66
UP3-RK	●	●		15	2	●	●			●	●	●		66
UP6-RK	●	●		26	2	●	●			●	●	●		66
UP2/OIL	●	●		3,3	1,5		●					●		68
UP3/OIL	●	●		5,5	2		●					●		68
UP3/OIL-R	●	●		5,5	2		●					●		68
UP6/OIL	●	●		8	5		●		●			●		69
UP12/OIL	●	●		15	3		●					●		69
UP12-LO	●	●		22	3		●					●		69
UP12-LOCK	●	●		22	3		●					●	●	70
UP14/OIL	●	●		18,3	2		●					●		70
NEW UP1-J/OIL	●	●		15	1		●					●		70
NEW UP6/OIL-AC			●	14	5		●		●					71
NEW UP14/OIL-AC			●	21	4		●		●					71
OCK1	●	●		5,5	2		●					●	●	72
OCK1-R	●	●		5,5	2		●					●	●	72
OCK8-E	●	●		10	3,5	●	●		●	●		●	●	73
OCK1-E	●	●		15	2	●	●			●		●	●	73
OCS3/E	●	●		10	2		●			●		●		74
OCS5/E	●	●		10	2		●			●		●		74
OCS6/E	●	●		15	2		●			●		●		74
OCS9/E	●	●		15	2		●			●		●		74

Prodotti e caratteristiche tecniche aggiornate a Luglio 2022. La MARCO S.p.A. si riserva il diritto di modificare in qualsiasi momento e senza preavviso le caratteristiche tecniche dei prodotti contenuti in questo catalogo. Il cliente precisi in fase d'offerta/ordine le caratteristiche tecniche richieste.

Neuester Stand der Produkte und technische Eigenschaften: Juli 2022. Die Firma MARCO S.p.A. behält sich das Recht vor in jedem Moment und ohne vorherigem Hinweis, die technischen Daten, der in diesem Katalog angegebenen Produkte, zu verändern. Der Kunde ist gebeten sich bei Anfrage/Bestellung nach den aktuellen Daten zu erkundigen.

Les produits et les caractéristiques techniques sont mis à jour à Juillet 2022. La maison MARCO S.p.A. se réserve le droit de modifier à n'importe quel moment y sans préavis les caractéristiques techniques des produit illustrés dans ce catalogue. Le client doit préciser lorsque de la demande d'offre ou de la commande les caractéristiques techniques demandées. Products and technical details are updated as of July 2022.

The Company MARCO S.p.A. reserves the right to alter the technical details of the products illustrated in this catalogue at any time whatsoever, without any prior notice. Customers must specify the technical specifications required when enquiring or ordering the products.

Los productos y los detalles técnicos son actualizados al mes de Julio 2022. La Sociedad MARCO S.p.A. se reserva el derecho de alterar los detalles técnicos de los productos ilustrados en este catálogo en cualquier momento y sin preaviso. Los clientes tienen que precisar en los pedidos de cotización o sea en las ordenes los detalles técnicos requeridos.

Produtos e características técnicas actualizados em Julho 2022. A Firma MARCO S.p.A. reservase o direito de modificar os dethales técnicos dos produtos ilustrados no catálogo em qualquer momento e sem préaviso. Os clientes tem que precisar quando da solicitação de pedido ou da encomenda os detalhes técnicos requeridos.

MARCO[®]

Via Mameli, 10
25014 Castenedolo
Brescia - Italy

Tel. +39 030 2134.1
Fax +39 030 2134.300
E-mail: info@marco.it

www.marco.it



VENDITE EXPORT

E-mail: export@marco.it
Tel. +39 030 2134.362
Fax +39 030 2134.302

VENDITE ITALIA

E-mail: vendite@marco.it
Tel. +39 030 2134.361
Fax +39 030 2134.301

U.S. Branch

MATE
USA 

MATE USA, LLC
3251-A S.W. 13th Dr.
Deerfield Beach
FL 33442

Phone 954-463-5757
Fax 954-463-5635

www.mate-usa.com
info@mate-usa.com
orders@mate-usa.com